

wymiary w [mm]
dimensions [mm]

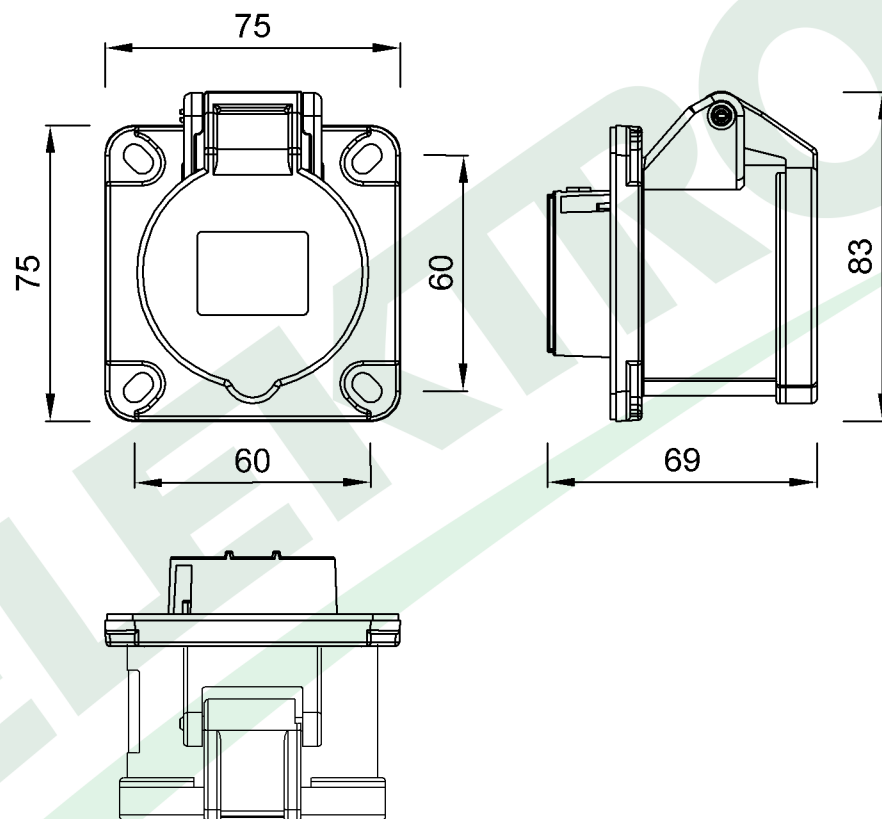

**PARAMETRY
PARAMETERS**

napięcie voltage	380V - 415V
natężenie prądu current	16A
częstotliwość frequency	50Hz-60Hz
ilość pól number of poles	4 (3P+E)
stopień ochrony international protection	IP44

F7.0079	Gniazdo tablicowe proste 16A 4p IP44 Angled Panel Socket 16A 4p IP44
F-ELEKTRO www.f-elektro.com, e-mail: info@f-elektro.com	