

wymiary w [mm]
dimensions [mm]

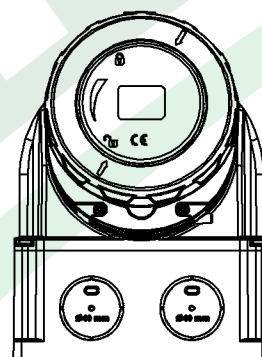
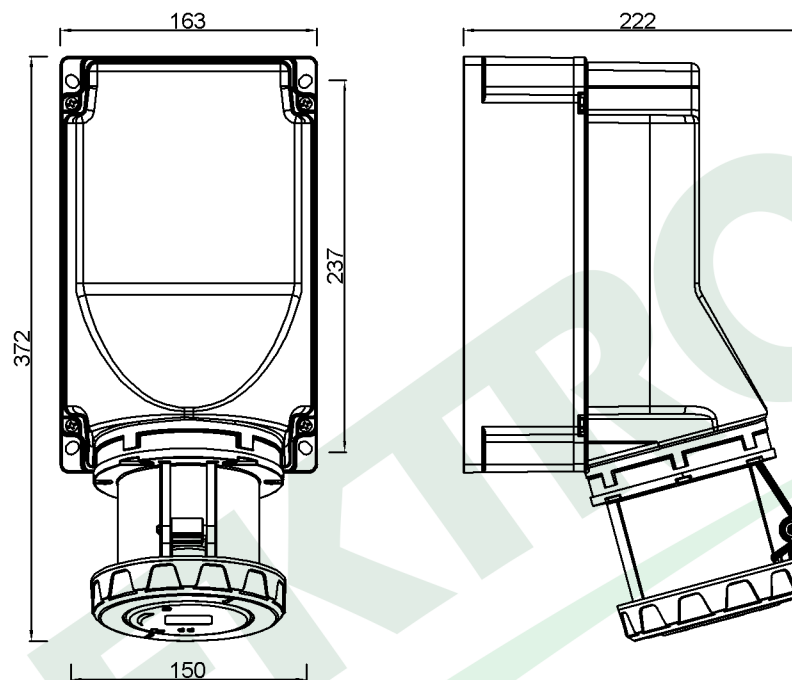

**PARAMETRY
PARAMETERS**

napięcie voltage	380V-415V
natężenie prądu current	125A
częstotliwość frequency	50Hz-60Hz
ilość pól number of poles	5 (3P+N+E)
stopień ochrony international protection	IP67

F7.0047 Gniazdo siłowe stałe 125A 5p IP67
Angled Surface Socket 125A 5p IP67

F-ELEKTRO
www.f-elektro.com,
e-mail: info@f-elektro.com