

wymiary w [mm]
dimensions [mm]

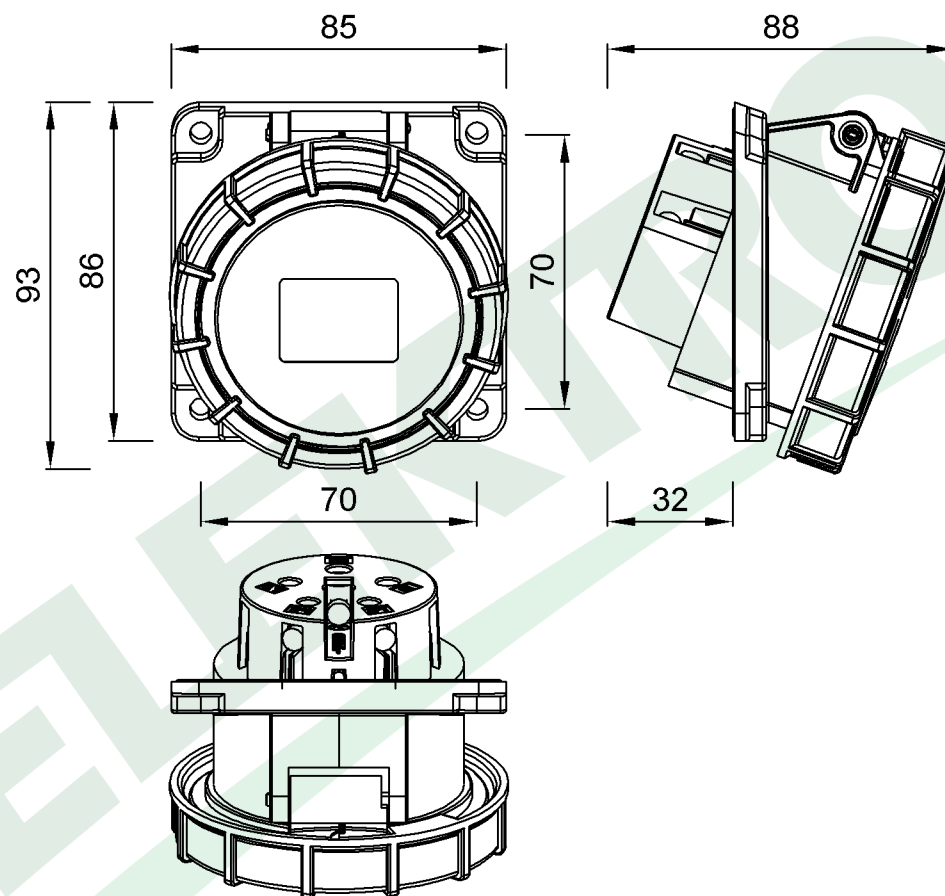

**PARAMETRY
PARAMETERS**

napięcie voltage	380V - 415V
natężenie prądu current	16A
częstotliwość frequency	50Hz-60Hz
ilość pól number of poles	5 (3P+N+E)
stopień ochrony international protection	IP67

F7.0041

Gniazdo siłowe tablicowe skośne 16A 5p IP67
Angled Panel Socket 16A 5p IP67

F-ELEKTRO

www.f-elektro.com,
e-mail: info@f-elektro.com