

F-ELEKTRO®

Producer of distribution boxes and electrical equipment

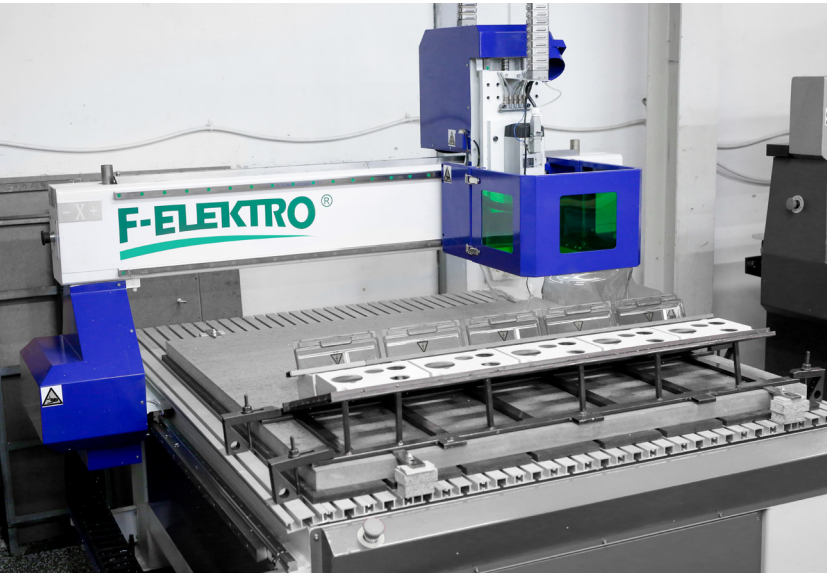

PRODUCT CATALOGUE
2 0 2 3



WE CREATE THE FUTURE

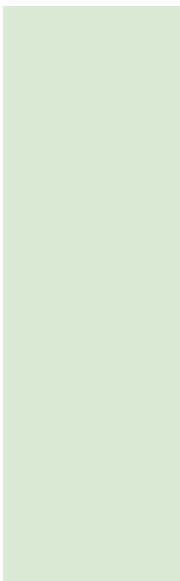
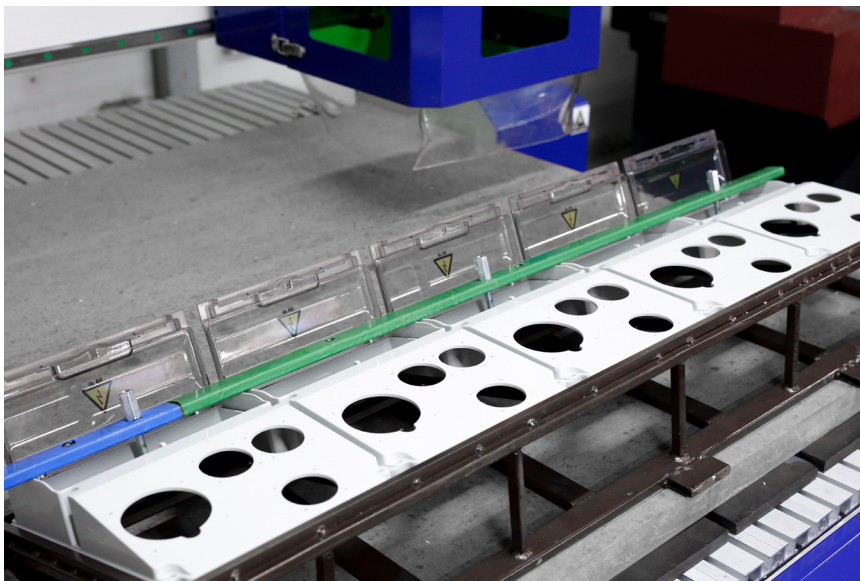
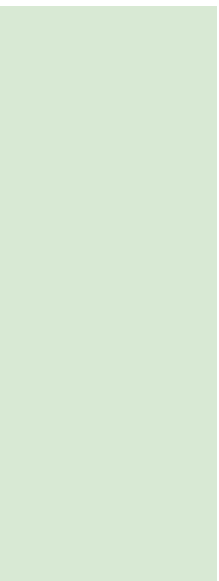
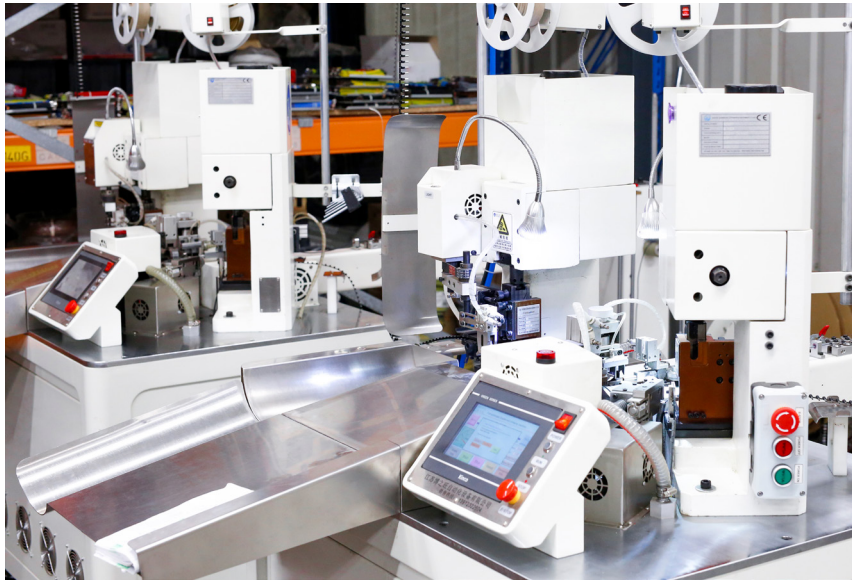
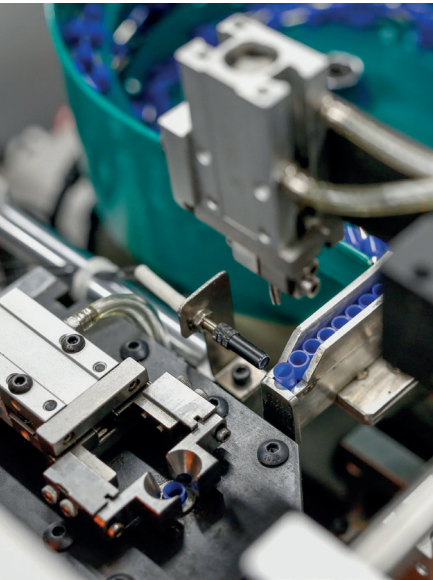

CONTENTS

DISTRIBUTION BOXES IP44	5-46
INDUSTRIAL DISTRIBUTION BOXES IP65	47-48
DISTRIBUTION BOXES IP65	49-54
ACCESSORIES FOR DISTRIBUTION BOXES	55
CARAVAN SYSTEMS	56
CARAVAN ADAPTOR 230V	57
ADAPTOR 400V / 230V	57
ADAPTOR 400V	57
CABLE EXTENSION 230V / 400V	58-62
CABLE REELS 230V / 400V	63-80
EMPTY CABLE REELS WITH SOCKETS	81-84
EMPTY CABLE REELS	85
INDUSTRIAL PLUGS AND SOCKETS 24V	86
INDUSTRIAL PLUGS AND SOCKETS 230V	86-88
INDUSTRIAL PLUGS AND SOCKETS 400V	89-93
PANELS SWITCH AND CASED SWITCH	94-95
TERMINAL STRIPS	96-100
TERMINAL BLOCKS	101-103
CURRENT PROTECTION TERMINALS	104-106
TERMINAL STRIPS SELF-LOCKING	107
TERMINAL STRIPS IN HOUSING	108-110
FORK AND PIN BUSBARS	111-112
PLASTIC PANEL	113-114
METAL PANEL	115
SLOTTED CABLE DUCTS	116
VENTILATION SYSTEM	117-118
BUTTON BOXES	119
LED INDICATOR LIGHTS	119
RUBBER PLUGS AND SOCKETS 230V	120-122
PLUGS AND SOCKETS 230V	123-124
CONNECTING CORD	125-127
CABLE GLANDS PG / MG	128-129
BOXES	130-137
LIGHTNING INSTALLATION	138-140
FLEXIBLE CORRUGATED PIPES GUS	141
CORRUGATED TUBES PCV / PE	142
FASTENING TECHNIQUES	143
CABLE TIES	144
WARNING CABLE FOIL	145
EARTHING ROD	146
MANHOLE BOXES	146
JUNCTON BOXES	146



CONTACT US

Registered office address:

F-ELEKTRO Sp. z o.o. Sp. kom.
Słoneczna 9
34-120 Roczyny

TIN: 551-256-25-25
KRS: 0000334959
Nr GIOŚ: E0012040WZ

Customer Service department:

Tel: + 48 33 506 50 00, + 48 33 873 31 73
Mob. +48 660 707 469
E-mail: info@f-elektro.com

Export department:

Mob. + 48 882 427 796
E-mail: export@f-elektro.com

Sales Director

Robert Najbor
Mob. + 48 728 960 010
E-mail: robertnajbor@f-elektro.com

Office/warehouse address:

F-ELEKTRO Sp. z o.o. Sp. kom.
Wałowa 30
34-100 Wadowice

www.f-elektro.com

Technical / Sales department:

Mob. + 48 795 198 489
Mob. + 48 728 960 009
E-mail: techniczny@f-elektro.com

Accounting department:

Mob. + 48 33 506 50 00 (extension 25)
E-mail: ksiegowosc@f-elektro.com

Director of Domestic Sales

Grzegorz Bogucki
Mob. + 48 888 456 780
E-mail: grzegorzbogucki@f-elektro.com

SALES REGIONS

Region I - Piotr Karwacki

Mob. + 48 728 960 011
piotrkarwacki@f-elektro.com

Region II - Andrzej Sordyl

Mob. + 48 728 960 012
andrzejsordyl@f-elektro.com

Region III - Zbigniew Wojewodzic

Mob. + 48 602 692 996
zbigniewwojewodzic@f-elektro.com

Region IV - Grzegorz Chojnacki

Mob. + 48 739 520 865
grzegorzchojnacki@f-elektro.com

Region V - Sławomir Lichota

Mob. + 48 668 686 792
slawomirlichota@f-elektro.com

Region VI - Marzena Salmanowicz

Mob. + 48 728 321 723
marzenasalmanowicz@f-elektro.com



DISTRIBUTION BOXES RS - KOMBI

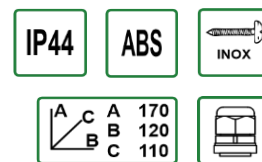
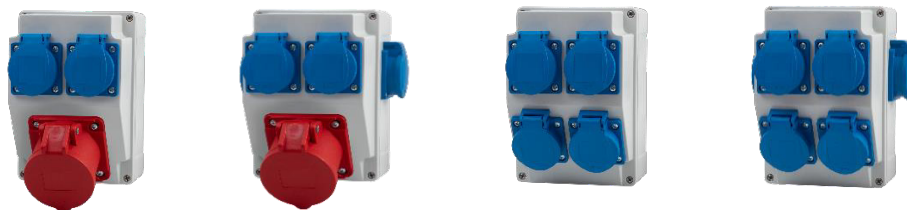

		Box	Unit
F3.1867	RS-KOMBI - sockets 16A 5p, 2x230V	1/1	pcs
F3.1868	RS-KOMBI - sockets 32A 5p, 2x230V	1/1	pcs
F3.1869	RS-KOMBI - sockets 16A 5p, 4x230V	1/1	pcs
F3.1870	RS-KOMBI - sockets 32A 5p, 4x230V	1/1	pcs
F3.1871	RS-KOMBI - sockets 4x230V	1/1	pcs
F3.1872	RS-KOMBI - sockets 6x230V	1/1	pcs

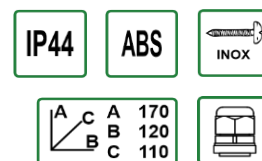

		Switch	Box	Unit
F3.1873	RS-KOMBI - sockets 16A 5p	0-1 (16A)	1/1	pcs
F3.1874	RS-KOMBI - sockets 32A 5p	0-1 (32A)	1/1	pcs
F3.1875	RS-KOMBI - sockets 16A 5p, 230V	0-1 (16A)	1/1	pcs
F3.1876	RS-KOMBI - sockets 32A 5p, 230V	0-1 (32A)	1/1	pcs
F3.1877	RS-KOMBI - sockets 16A 5p, 2x230V	0-1 (16A)	1/1	pcs
F3.1878	RS-KOMBI - sockets 32A 5p, 2x230V	0-1 (32A)	1/1	pcs
F3.1879	RS-KOMBI - sockets 16A 5p	L/P (16A)	1/1	pcs
F3.1880	RS-KOMBI - sockets 32A 5p	L/P (32A)	1/1	pcs
F3.1881	RS-KOMBI - sockets 16A 5p, 230V	L/P (16A)	1/1	pcs
F3.1882	RS-KOMBI - sockets 32A 5p, 230V	L/P (32A)	1/1	pcs
F3.1883	RS-KOMBI - sockets 16A 5p, 2x230V	L/P (16A)	1/1	pcs
F3.1884	RS-KOMBI - sockets 32A 5p, 2x230V	L/P (32A)	1/1	pcs

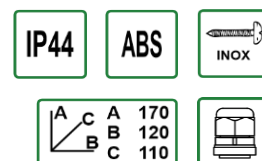

		Closing switch	Box	Unit
F3.1885	RS-KOMBI - sockets 16A 5p	0-1 (16A)	1/1	pcs
F3.1886	RS-KOMBI - sockets 32A 5p	0-1 (32A)	1/1	pcs
F3.1887	RS-KOMBI - sockets 16A 5p, 230V	0-1 (16A)	1/1	pcs
F3.1888	RS-KOMBI - sockets 32A 5p, 230V	0-1 (32A)	1/1	pcs
F3.1889	RS-KOMBI - sockets 16A 5p, 2x230V	0-1 (16A)	1/1	pcs
F3.1890	RS-KOMBI - sockets 32A 5p, 2x230V	0-1 (32A)	1/1	pcs
F3.1891	RS-KOMBI - sockets 16A 5p	L/P (16A)	1/1	pcs
F3.1892	RS-KOMBI - sockets 32A 5p	L/P (32A)	1/1	pcs
F3.1893	RS-KOMBI - sockets 16A 5p, 230V	L/P (16A)	1/1	pcs
F3.1894	RS-KOMBI - sockets 32A 5p, 230V	L/P (32A)	1/1	pcs
F3.1895	RS-KOMBI - sockets 16A 5p, 2x230V	L/P (16A)	1/1	pcs
F3.1896	RS-KOMBI - sockets 32A 5p, 2x230V	L/P (32A)	1/1	pcs

DISTRIBUTION BOXES BICO

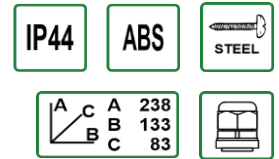

		Switch	Box	Unit
F3.0797	BICO - sockets 16A 3p	0-1 (16A)	1/1	pcs
F3.0800	BICO - sockets 32A 3p	0-1 (25A)	1/1	pcs
F3.0798	BICO - sockets 16A 3p, 230V	0-1 (16A)	1/1	pcs
F3.0801	BICO - sockets 32A 3p, 230V	0-1 (25A)	1/1	pcs
F3.0799	BICO - sockets 16A 3p, 2x230V	0-1 (16A)	1/1	pcs
F3.0802	BICO - sockets 32A 3p, 2x230V	0-1 (25A)	1/1	pcs

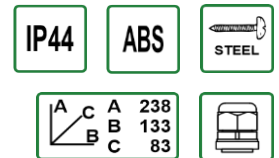

		Switch	Box	Unit
F3.0365	BICO - sockets 16A 5p	0-1 (16A)	1/1	pcs
F3.0368	BICO - sockets 32A 5p	0-1 (25A)	1/1	pcs
F3.0366	BICO - sockets 16A 5p, 230V	0-1 (16A)	1/1	pcs
F3.0369	BICO - sockets 32A 5p, 230V	0-1 (25A)	1/1	pcs
F3.0367	BICO - sockets 16A 5p, 2x230V	0-1 (16A)	1/1	pcs
F3.0370	BICO - sockets 32A 5p, 2x230V	0-1 (25A)	1/1	pcs
F3.0371	BICO - sockets 16A 5p	L/P (16A)	1/1	pcs
F3.0374	BICO - sockets 32A 5p	L/P (25A)	1/1	pcs
F3.0372	BICO - sockets 16A 5p, 230V	L/P (16A)	1/1	pcs
F3.0375	BICO - sockets 32A 5p, 230V	L/P (25A)	1/1	pcs
F3.0373	BICO - sockets 16A 5p, 2x230V	L/P (16A)	1/1	pcs
F3.0376	BICO - sockets 32A 5p, 2x230V	L/P (25A)	1/1	pcs

DISTRIBUTION BOXES R-150

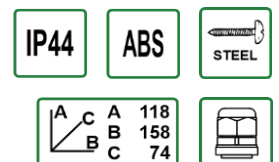

		Box	Unit
F3.0083	R-150 - sockets 16A 5p, 230V	1/1	pcs
F3.0084	R-150 - sockets 32A 5p, 230V with fuse	1/1	pcs
F3.0306	R-150 - sockets 2x230V	1/1	pcs

DISTRIBUTION BOXES R-190

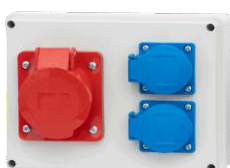

IP44 ABS STEEL

A	A	154
C	B	199
B	C	77

		Box	Unit
F3.0122	R-190 - sockets 16A 5p, 32A 5p	1/1	pcs
F3.0123	R-190 - sockets 2x16A 5p	1/1	pcs
F3.0124	R-190 - sockets 2x32A 5p	1/1	pcs
F3.0085	R-190 - sockets 16A 5p, 2x230V	1/1	pcs
F3.0086	R-190 - sockets 32A 5p, 2x230V	1/1	pcs
F3.0307	R-190 - sockets 16A 5p, 32A 5p, 2x230V	1/1	pcs
F3.0308	R-190 - sockets 2x16A 5p, 2x230V	1/1	pcs
F3.0309	R-190 - sockets 2x32A 5p, 2x230V	1/1	pcs



IP44 ABS STEEL

A	A	199
C	B	154
B	C	77

		Box	Unit
F3.0121	R-190 - sockets 4x230V	1/1	pcs
F3.0264	R-190 - sockets 6x230V	1/1	pcs



IP44 ABS STEEL

A	A	154
C	B	199
B	C	77

		Switch	Box	Unit
F3.0774	R-190 - sockets 16A 3p	0-1 (16A)	1/1	pcs
F3.0775	R-190 - sockets 32A 3p	0-1 (25A)	1/1	pcs
F3.0776	R-190 - sockets 16A 5p	0-1 (16A)	1/1	pcs
F3.0777	R-190 - sockets 32A 5p	0-1 (25A)	1/1	pcs
F3.0778	R-190 - sockets 16A 5p	L/P (16A)	1/1	pcs
F3.0779	R-190 - sockets 32A 5p	L/P (25A)	1/1	pcs



IP44 ABS STEEL

A	A	154
C	B	199
B	C	77

		Switch	Box	Unit
F3.0780	R-190 - sockets 16A 3p, 230V	0-1 (16A)	1/1	pcs
F3.0781	R-190 - sockets 32A 3p, 230V	0-1 (25A)	1/1	pcs
F3.0087	R-190 - sockets 16A 5p, 230V	0-1 (16A)	1/1	pcs
F3.0088	R-190 - sockets 32A 5p, 230V	0-1 (25A)	1/1	pcs
F3.0089	R-190 - sockets 16A 5p, 230V	L/P (16A)	1/1	pcs
F3.0090	R-190 - sockets 32A 5p, 230V	L/P (25A)	1/1	pcs

DISTRIBUTION BOXES R-240

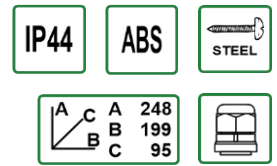

		Box	Unit
F3.0097	R-240 - sockets 16A 5p, 32A 5p, 2x230V	1/1	pcs
F3.0098	R-240 - sockets 2x16A 5p, 2x230V	1/1	pcs
F3.0099	R-240 - sockets 2x32A 5p, 2x230V	1/1	pcs
F3.0768	R-240 - sockets 16A 5p, 32A 5p, 3x230V	1/1	pcs
F3.0769	R-240 - sockets 2x16A 5p, 3x230V	1/1	pcs
F3.0770	R-240 - sockets 2x32A 5p, 3x230V	1/1	pcs
F3.0100	R-240 - sockets 16A 5p, 32A 5p, 4x230V	1/1	pcs
F3.0101	R-240 - sockets 2x16A 5p, 4x230V	1/1	pcs
F3.0102	R-240 - sockets 2x32A 5p, 4x230V	1/1	pcs

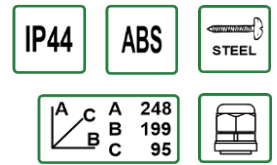
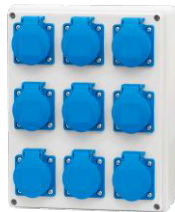

		Box	Unit
F3.0140	R-240 - sockets 8x230V	1/1	pcs
F3.0771	R-240 - sockets 9x230V	1/1	pcs

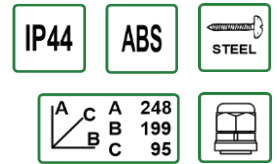

		Box	Unit
F3.0293	R-240 - sockets 16A 5p, 3x32A 5p	1/1	pcs
F3.0291	R-240 - sockets 2x16A 5p, 2x32A 5p	1/1	pcs
F3.0292	R-240 - sockets 3x16A 5p, 32A 5p	1/1	pcs
F3.0289	R-240 - sockets 4x16A 5p	1/1	pcs
F3.0290	R-240 - sockets 4x32A 5p	1/1	pcs
F3.0305	R-240 - sockets 16A 5p, 2x32A 5p, 2x230V	1/1	pcs
F3.0304	R-240 - sockets 2x16A 5p, 32A 5p, 2x230V	1/1	pcs
F3.0303	R-240 - sockets 3x16A 5p, 2x230V	1/1	pcs
F3.0302	R-240 - sockets 3x32A 5p, 2x230V	1/1	pcs
F3.0772	R-240 - sockets 16A 5p, 6x230V	1/1	pcs
F3.0773	R-240 - sockets 32A 5p, 6x230V	1/1	pcs

DISTRIBUTION BOXES R-240

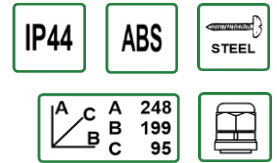

		Switch	Box	Unit
F3.0091	R-240 - sockets 16A 5p, 32A 5p, 2x230V	0-1 (32A)	1/1	pcs
F3.0092	R-240 - sockets 2x16A 5p, 2x230V	0-1 (32A)	1/1	pcs
F3.0093	R-240 - sockets 2x32A 5p, 2x230V	0-1 (32A)	1/1	pcs
F3.0782	R-240 - sockets 16A 5p, 4x230V	0-1 (16A)	1/1	pcs
F3.0783	R-240 - sockets 32A 5p, 4x230V	0-1 (32A)	1/1	pcs
F3.0094	R-240 - sockets 16A 5p, 32A 5p, 2x230V	L/P (32A)	1/1	pcs
F3.0095	R-240 - sockets 2x16A 5p, 2x230V	L/P (32A)	1/1	pcs
F3.0096	R-240 - sockets 2x32A 5p, 2x230V	L/P (32A)	1/1	pcs
F3.0784	R-240 - sockets 16A 5p, 4x230V	L/P (16A)	1/1	pcs
F3.0785	R-240 - sockets 32A 5p, 4x230V	L/P (32A)	1/1	pcs

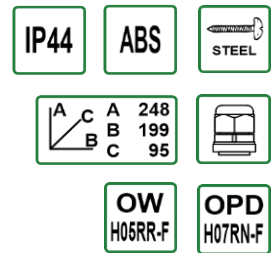
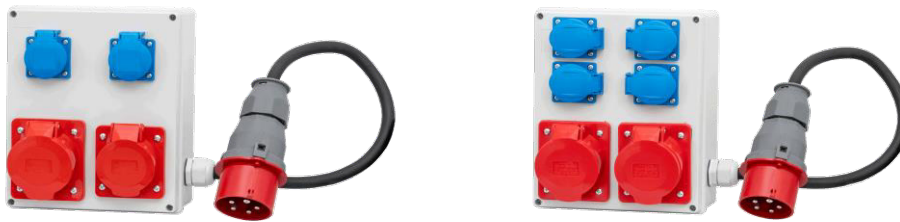

		Plug	Wire	Box	Unit
F3.0103	R-240 - sockets 16A 5p, 32A 5p, 2x230V	16A 5p	/1,5m/ OW 5x2,5mm ²	1/1	pcs
F3.0390	R-240 - sockets 16A 5p, 32A 5p, 4x230V	16A 5p	/1,5m/ OW 5x2,5mm ²	1/1	pcs
F3.0104	R-240 - sockets 2x16A 5p, 2x230V	16A 5p	/1,5m/ OW 5x2,5mm ²	1/1	pcs
F3.0389	R-240 - sockets 2x32A 5p, 2x230V	32A 5p	/1,5m/ OPD 5x4,0mm ²	1/1	pcs
F3.0391	R-240 - sockets 2x32A 5p, 4x230V	32A 5p	/1,5m/ OPD 5x4,0mm ²	1/1	pcs

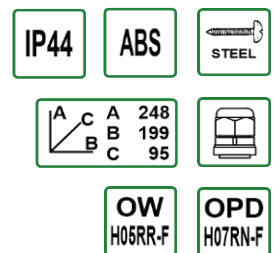

		Plug	Switch	Wire	Box	Unit
F3.0106	R-240 - sockets 16A 5p, 32A 5p, 2x230V	16A 5p	0-1 (32A)	/1,5m/ OW 5x2,5mm ²	1/1	pcs
F3.0107	R-240 - sockets 2x16A 5p, 2x230V	16A 5p	0-1 (32A)	/1,5m/ OW 5x2,5mm ²	1/1	pcs
F3.0146	R-240 - sockets 2x32A 5p, 2x230V	32A 5p	0-1 (32A)	/1,5m/ OPD 5x4,0mm ²	1/1	pcs
F3.0109	R-240 - sockets 16A 5p, 32A 5p, 2x230V	16A 5p	L/P (32A)	/1,5m/ OW 5x2,5mm ²	1/1	pcs
F3.0110	R-240 - sockets 2x16A 5p, 2x230V	16A 5p	L/P (32A)	/1,5m/ OW 5x2,5mm ²	1/1	pcs
F3.0147	R-240 - sockets 2x32A 5p, 2x230V	32A 5p	L/P (32A)	/1,5m/ OPD 5x4,0mm ²	1/1	pcs

DISTRIBUTION BOXES R-240 ON PLASTIC FRAME

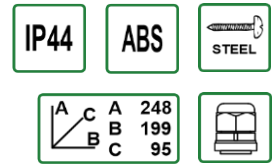

		Box	Unit
F3.0869	R-240 - sockets 16A 5p, 32A 5p, 2x230V	1/1	pcs
F3.0867	R-240 - sockets 2x16A 5p, 2x230V	1/1	pcs
F3.0868	R-240 - sockets 2x32A 5p, 2x230V	1/1	pcs
F3.0872	R-240 - sockets 16A 5p, 32A 5p, 3x230V	1/1	pcs
F3.0870	R-240 - sockets 2x16A 5p, 3x230V	1/1	pcs
F3.0871	R-240 - sockets 2x32A 5p, 3x230V	1/1	pcs
F3.0875	R-240 - sockets 16A 5p, 32A 5p, 4x230V	1/1	pcs
F3.0873	R-240 - sockets 2x16A 5p, 4x230V	1/1	pcs
F3.0874	R-240 - sockets 2x32A 5p, 4x230V	1/1	pcs

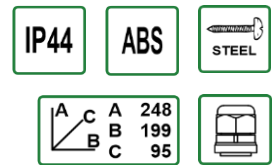

		Box	Unit
F3.0876	R-240 - sockets 8x230V	1/1	pcs
F3.1837	R-240 - sockets 9x230V	1/1	pcs

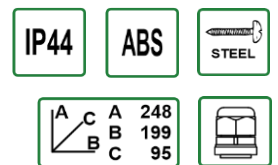

		Switch	Box	Unit
F3.0889	R-240 - sockets 16A 5p, 32A 5p, 2x230V	0-1 (32A)	1/1	pcs
F3.0887	R-240 - sockets 2x16A 5p, 2x230V	0-1 (32A)	1/1	pcs
F3.0888	R-240 - sockets 2x32A 5p, 2x230V	0-1 (32A)	1/1	pcs
F3.0892	R-240 - sockets 16A 5p, 32A 5p, 2x230V	L/P (32A)	1/1	pcs
F3.0890	R-240 - sockets 2x16A 5p, 2x230V	L/P (32A)	1/1	pcs
F3.0891	R-240 - sockets 2x32A 5p, 2x230V	L/P (32A)	1/1	pcs

DISTRIBUTION BOXES R-240 ON PLASTIC FRAME

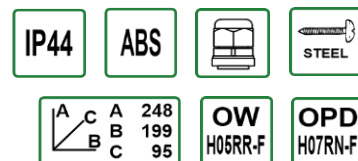

		Plug	Switch	Wire	Box	Unit
F3.0895	R-240 - sockets 16A 5p, 32A 5p, 2x230V	16A 5p	0-1 (32A)	/1,5m/ OW 5x2,5mm ²	1/1	pcs
F3.0893	R-240 - sockets 2x16A 5p, 2x230V	16A 5p	0-1 (32A)	/1,5m/ OW 5x2,5mm ²	1/1	pcs
F3.0894	R-240 - sockets 2x32A 5p, 2x230V	32A 5p	0-1 (32A)	/1,5m/ OPD 5x4,0mm ²	1/1	pcs
F3.0898	R-240 - sockets 16A 5p, 32A 5p, 2x230V	16A 5p	L/P (32A)	/1,5m/ OW 5x2,5mm ²	1/1	pcs
F3.0896	R-240 - sockets 2x16A 5p, 2x230V	16A 5p	L/P (32A)	/1,5m/ OW 5x2,5mm ²	1/1	pcs
F3.0897	R-240 - sockets 2x32A 5p, 2x230V	32A 5p	L/P (32A)	/1,5m/ OPD 5x4,0mm ²	1/1	pcs

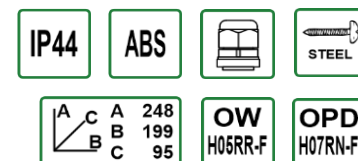

		Plug	Wire	Box	Unit
F3.0913	R-240 - sockets 16A 5p, 32A 5p, 2x230V	16A 5p	/1,5m/ OW 5x2,5mm ²	1/1	pcs
F3.0911	R-240 - sockets 2x16A 5p, 2x230V	16A 5p	/1,5m/ OW 5x2,5mm ²	1/1	pcs
F3.0912	R-240 - sockets 2x32A 5p, 2x230V	32A 5p	/1,5m/ OPD 5x4,0mm ²	1/1	pcs
F3.0916	R-240 - sockets 16A 5p, 32A 5p, 3x230V	16A 5p	/1,5m/ OW 5x2,5mm ²	1/1	pcs
F3.0914	R-240 - sockets 2x16A 5p, 3x230V	16A 5p	/1,5m/ OW 5x2,5mm ²	1/1	pcs
F3.0915	R-240 - sockets 2x32A 5p, 3x230V	32A 5p	/1,5m/ OPD 5x4,0mm ²	1/1	pcs
F3.0919	R-240 - sockets 16A 5p, 32A 5p, 4x230V	16A 5p	/1,5m/ OW 5x2,5mm ²	1/1	pcs
F3.0917	R-240 - sockets 2x16A 5p, 4x230V	16A 5p	/1,5m/ OW 5x2,5mm ²	1/1	pcs
F3.0918	R-240 - sockets 2x32A 5p, 4x230V	32A 5p	/1,5m/ OPD 5x4,0mm ²	1/1	pcs



		Plug	Wire	Box	Unit
F3.0920	R-240 - sockets 8x230V	16A 5p	/1,5m/ OW 5x2,5mm ²	1/1	pcs
F3.1836	R-240 - sockets 9x230V	16A 5p	/1,5m/ OW 5x2,5mm ²	1/1	pcs

DISTRIBUTION BOXES R-310

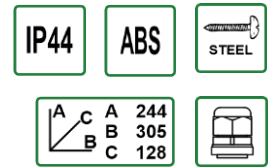

Code	Description	Switch	Box	Unit
F3.0341	R-310 - sockets 2x16A 5p, 2x32A 5p, 2x230V		1/1	pcs
F3.0342	R-310 - sockets 4x16A 5p, 2x230V		1/1	pcs
F3.0343	R-310 - sockets 4x32A 5p, 2x230V		1/1	pcs

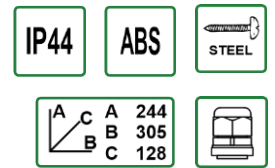

Code	Description	Switch	Box	Unit
F3.0344	R-310 - sockets 3x16A 5p, 3x230V	0-1 (63A)	1/1	pcs
F3.0346	R-310 - sockets 3x32A 5p, 3x230V	0-1 (63A)	1/1	pcs
F3.0345	R-310 - sockets 3x16A 5p, 3x230V	L/P (63A)	1/1	pcs
F3.0347	R-310 - sockets 3x32A 5p, 3x230V	L/P (63A)	1/1	pcs

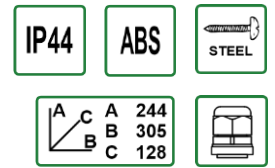

Code	Description	Switch	Box	Unit
F3.0355	R-310 - sockets 2x16A 5p, 4x230V	0-1 (32A)	1/1	pcs
F3.0357	R-310 - sockets 2x32A 5p, 4x230V	0-1 (32A)	1/1	pcs
F3.0356	R-310 - sockets 2x16A 5p, 4x230V	L/P (32A)	1/1	pcs
F3.0358	R-310 - sockets 2x32A 5p, 4x230V	L/P (32A)	1/1	pcs

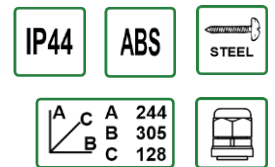

Code	Description	Switch	Box	Unit
F3.0294	R-310 - sockets 63A 5p	0-1 (63A)	1/1	pcs
F3.0295	R-310 - sockets 63A 5p, 230V with fuse	0-1 (63A)	1/1	pcs
F3.0296	R-310 - sockets 63A 5p, 2x230V with fuse	0-1 (63A)	1/1	pcs
F3.0297	R-310 - sockets 63A 5p	L/P (63A)	1/1	pcs
F3.0298	R-310 - sockets 63A 5p, 230V with fuse	L/P (63A)	1/1	pcs
F3.0299	R-310 - sockets 63A 5p, 2x230V with fuse	L/P (63A)	1/1	pcs

DISTRIBUTION BOXES HORIZONTAL

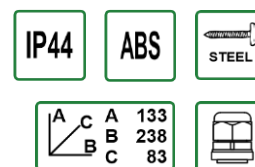

		Box	Unit
F3.1838	Horizontal - sockets 16A 5p, 32A 5p	1/1	pcs
F3.1249	Horizontal - sockets 2x16A 5p	1/1	pcs
F3.1839	Horizontal - sockets 2x32A 5p	1/1	pcs
F3.1840	Horizontal - sockets 16A 5p, 32A 5p, 230V	1/1	pcs
F3.1315	Horizontal - sockets 2x16A 5p, 230V	1/1	pcs
F3.1841	Horizontal - sockets 2x32A 5p, 230V	1/1	pcs
F3.1842	Horizontal - sockets 16A 5p, 2x230V	1/1	pcs
F3.1492	Horizontal - sockets 32A 5p, 2x230V	1/1	pcs
F3.1491	Horizontal - sockets 4x230V	1/1	pcs

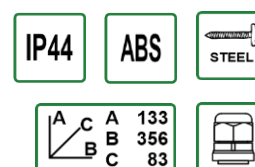

		Box	Unit
F3.0426	Horizontal S - sockets 16A 5p, 2x32A 5p	1/1	pcs
F3.0427	Horizontal S - sockets 2x16A 5p, 32A 5p	1/1	pcs
F3.0424	Horizontal S - sockets 3x16A 5p	1/1	pcs
F3.0425	Horizontal S - sockets 3x32A 5p	1/1	pcs
F3.0428	Horizontal S - sockets 16A 5p, 32A 5p, 2x230V	1/1	pcs
F3.0429	Horizontal S - sockets 2x16A 5p, 2x230V	1/1	pcs
F3.0430	Horizontal S - sockets 2x32A 5p, 2x230V	1/1	pcs

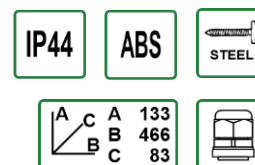

		Box	Unit
F3.0434	Horizontal B - sockets 16A 5p, 3x32A 5p	1/1	pcs
F3.0433	Horizontal B - sockets 2x16A 5p, 2x32A 5p	1/1	pcs
F3.0435	Horizontal B - sockets 3x16A 5p, 32A 5p	1/1	pcs
F3.0431	Horizontal B - sockets 4x16A 5p	1/1	pcs
F3.0432	Horizontal B - sockets 4x32A 5p	1/1	pcs
F3.0436	Horizontal B - sockets 3x16A 5p, 2x230V	1/1	pcs
F3.0437	Horizontal B - sockets 3x32A 5p, 2x230V	1/1	pcs
F3.0438	Horizontal B - sockets 2x16A 5p, 32A 5p, 2x230V	1/1	pcs
F3.0439	Horizontal B - sockets 16A 5p, 2x32A 5p, 2x230V	1/1	pcs

DISTRIBUTION BOXES VERTICAL

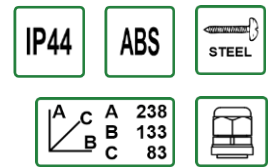
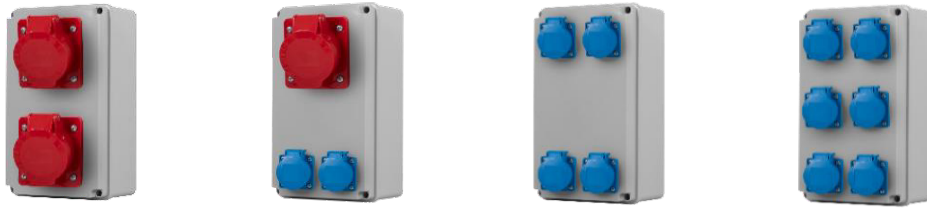

		Box	Unit
F3.1126	Vertical - sockets 16A 5p, 32A 5p	1/1	pcs
F3.1124	Vertical - sockets 2x16A 5p	1/1	pcs
F3.1125	Vertical - sockets 2x32A 5p	1/1	pcs
F3.1127	Vertical - sockets 16A 5p, 2x230V	1/1	pcs
F3.1128	Vertical - sockets 32A 5p, 2x230V	1/1	pcs
F3.1129	Vertical - sockets 4x230V	1/1	pcs
F3.1130	Vertical - sockets 6x230V	1/1	pcs

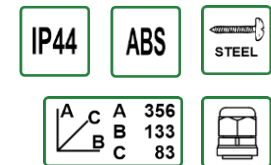

		Box	Unit
F3.0414	Vertical S - sockets 16A 5p, 32A 5p, 2x230V	1/1	pcs
F3.0412	Vertical S - sockets 2x16A 5p, 2x230V	1/1	pcs
F3.0413	Vertical S - sockets 2x32A 5p, 2x230V	1/1	pcs
F3.0415	Vertical S - sockets 16A 5p, 4x230V	1/1	pcs
F3.0416	Vertical S - sockets 32A 5p, 4x230V	1/1	pcs

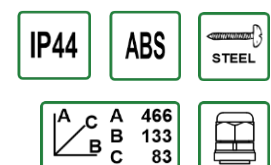

		Box	Unit
F3.0419	Vertical B - sockets 16A 5p, 2x32A 5p, 2x230V	1/1	pcs
F3.0420	Vertical B - sockets 2x16A 5p, 32A 5p, 2x230V	1/1	pcs
F3.0417	Vertical B - sockets 3x16A 5p, 2x230V	1/1	pcs
F3.0418	Vertical B - sockets 3x32A 5p, 2x230V	1/1	pcs
F3.0421	Vertical B - sockets 2x16A 5p, 4x230V	1/1	pcs
F3.0422	Vertical B - sockets 2x32A 5p, 4x230V	1/1	pcs
F3.0423	Vertical B - sockets 16A 5p, 32A 5p, 4x230V	1/1	pcs

DISTRIBUTION BOXES POLYBOX



IP44 PA

A	C	A	140
B	B	B	188
C	B	C	86

INOX

		Plug	Box	Unit
F3.0595	POLYBOX - sockets 3x16A 5p	16A 5p	1/1	pcs
F3.0598	POLYBOX - sockets 16A 5p, 2x32A 5p	16A 5p	1/1	pcs
F3.0601	POLYBOX - sockets 2x16A 5p, 32A 5p	16A 5p	1/1	pcs
F3.0613	POLYBOX - sockets 3x32A 5p	32A 5p	1/1	pcs
F3.0616	POLYBOX - sockets 16A 5p, 2x32A 5p	32A 5p	1/1	pcs
F3.0619	POLYBOX - sockets 2x16A 5p, 32A 5p	32A 5p	1/1	pcs
F3.0596	POLYBOX - sockets 3x16A 5p, 230V	16A 5p	1/1	pcs
F3.0599	POLYBOX - sockets 16A 5p, 2x32A 5p, 230V	16A 5p	1/1	pcs
F3.0602	POLYBOX - sockets 2x16A 5p, 32A 5p, 230V	16A 5p	1/1	pcs
F3.0614	POLYBOX - sockets 3x32A 5p, 230V	32A 5p	1/1	pcs
F3.0617	POLYBOX - sockets 16A 5p, 2x32A 5p, 230V	32A 5p	1/1	pcs
F3.0620	POLYBOX - sockets 2x16A 5p, 32A 5p, 230V	32A 5p	1/1	pcs
F3.0597	POLYBOX - sockets 3x16A 5p, 2x230V	16A 5p	1/1	pcs
F3.0600	POLYBOX - sockets 16A 5p, 2x32A 5p, 2x230V	16A 5p	1/1	pcs
F3.0603	POLYBOX - sockets 2x16A 5p, 32A 5p, 2x230V	16A 5p	1/1	pcs
F3.0615	POLYBOX - sockets 3x32A 5p, 2x230V	32A 5p	1/1	pcs
F3.0618	POLYBOX - sockets 16A 5p, 2x32A 5p, 2x230V	32A 5p	1/1	pcs
F3.0621	POLYBOX - sockets 2x16A 5p, 32A 5p, 2x230V	32A 5p	1/1	pcs



IP44 PA

A	C	A	140
B	B	B	188
C	B	C	86

INOX



		Box	Unit
F3.0604	POLYBOX - sockets 3x16A 5p	1/1	pcs
F3.0607	POLYBOX - sockets 16A 5p, 2x32A 5p	1/1	pcs
F3.0610	POLYBOX - sockets 2x16A 5p, 32A 5p	1/1	pcs
F3.0622	POLYBOX - sockets 3x32A 5p	1/1	pcs
F3.0605	POLYBOX - sockets 3x16A 5p, 230V	1/1	pcs
F3.0608	POLYBOX - sockets 16A 5p, 2x32A 5p, 230V	1/1	pcs
F3.0611	POLYBOX - sockets 2x16A 5p, 32A 5p, 230V	1/1	pcs
F3.0623	POLYBOX - sockets 3x32A 5p, 230V	1/1	pcs
F3.0606	POLYBOX - sockets 3x16A 5p, 2x230V	1/1	pcs
F3.0609	POLYBOX - sockets 16A 5p, 2x32A 5p, 2x230V	1/1	pcs
F3.0612	POLYBOX - sockets 2x16A 5p, 32A 5p, 2x230V	1/1	pcs
F3.0624	POLYBOX - sockets 3x32A 5p, 2x230V	1/1	pcs

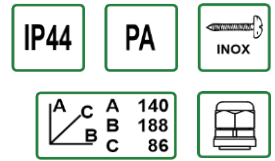
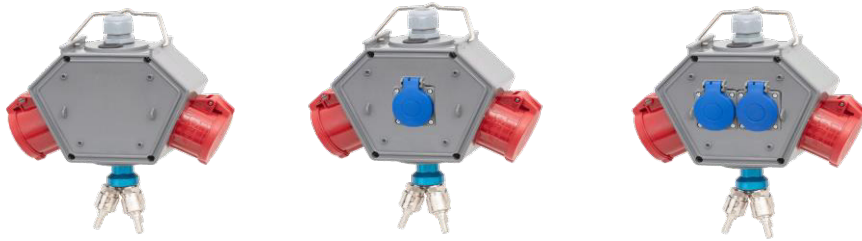

		Box	Unit
F3.0794	POLYBOX with air distributor - sockets 16A 5p, 32A 5p	1/1	pcs
F3.0788	POLYBOX with air distributor - sockets 2x16A 5p	1/1	pcs
F3.0791	POLYBOX with air distributor - sockets 2x32A 5p	1/1	pcs
F3.0795	POLYBOX with air distributor - sockets 16A 5p, 32A 5p, 230V	1/1	pcs
F3.0789	POLYBOX with air distributor - sockets 2x16A 5p, 230V	1/1	pcs
F3.0792	POLYBOX with air distributor - sockets 2x32A 5p, 230V	1/1	pcs
F3.0796	POLYBOX with air distributor - sockets 16A 5p, 32A 5p, 2x230V	1/1	pcs
F3.0790	POLYBOX with air distributor - sockets 2x16A 5p, 2x230V	1/1	pcs
F3.0793	POLYBOX with air distributor - sockets 2x32A 5p, 2x230V	1/1	pcs

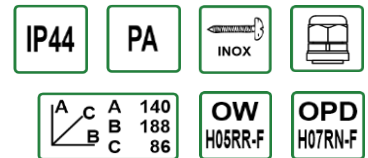
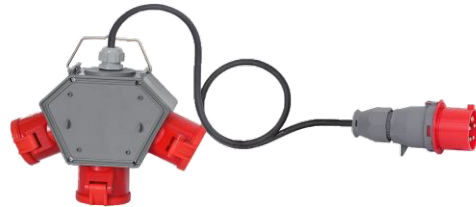

		Plug	Wire	Box	Unit
F3.0631	POLYBOX - sockets 3x16A 5p	16A 5p	/3m/ OW 5x2,5mm ²	1/1	pcs
F3.0634	POLYBOX - sockets 3x16A 5p	16A 5p	/5m/ OW 5x2,5mm ²	1/1	pcs
F3.0637	POLYBOX - sockets 3x16A 5p	16A 5p	/10m/ OW 5x2,5mm ²	1/1	pcs
F3.0640	POLYBOX - sockets 3x32A 5p	32A 5p	/3m/ OPD 5x4,0mm ²	1/1	pcs
F3.0643	POLYBOX - sockets 3x32A 5p	32A 5p	/5m/ OPD 5x4,0mm ²	1/1	pcs
F3.0646	POLYBOX - sockets 3x32A 5p	32A 5p	/10m/ OPD 5x4,0mm ²	1/1	pcs

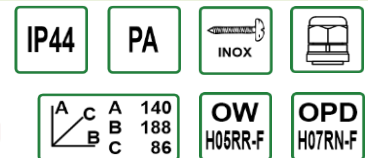
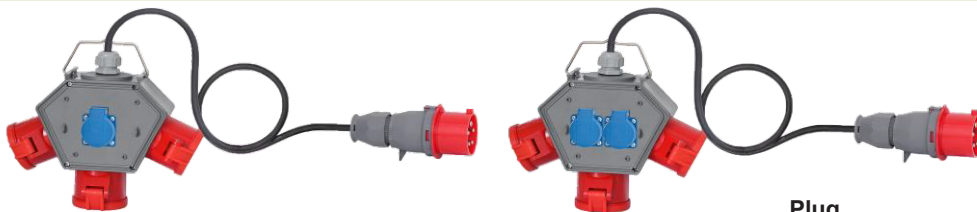

		Plug	Wire	Box	Unit
F3.0632	POLYBOX - sockets 3x16A 5p, 230V	16A 5p	/3m/ OW 5x2,5mm ²	1/1	pcs
F3.0635	POLYBOX - sockets 3x16A 5p, 230V	16A 5p	/5m/ OW 5x2,5mm ²	1/1	pcs
F3.0638	POLYBOX - sockets 3x16A 5p, 230V	16A 5p	/10m/ OW 5x2,5mm ²	1/1	pcs
F3.0641	POLYBOX - sockets 3x32A 5p, 230V	32A 5p	/3m/ OPD 5x4,0mm ²	1/1	pcs
F3.0644	POLYBOX - sockets 3x32A 5p, 230V	32A 5p	/5m/ OPD 5x4,0mm ²	1/1	pcs
F3.0647	POLYBOX - sockets 3x32A 5p, 230V	32A 5p	/10m/ OPD 5x4,0mm ²	1/1	pcs
F3.0633	POLYBOX - sockets 3x16A 5p, 2x230V	16A 5p	/3m/ OW 5x2,5mm ²	1/1	pcs
F3.0636	POLYBOX - sockets 3x16A 5p, 2x230V	16A 5p	/5m/ OW 5x2,5mm ²	1/1	pcs
F3.0639	POLYBOX - sockets 3x16A 5p, 2x230V	16A 5p	/10m/ OW 5x2,5mm ²	1/1	pcs
F3.0642	POLYBOX - sockets 3x32A 5p, 2x230V	32A 5p	/3m/ OPD 5x4,0mm ²	1/1	pcs
F3.0645	POLYBOX - sockets 3x32A 5p, 2x230V	32A 5p	/5m/ OPD 5x4,0mm ²	1/1	pcs
F3.0648	POLYBOX - sockets 3x32A 5p, 2x230V	32A 5p	/10m/ OPD 5x4,0mm ²	1/1	pcs

DISTRIBUTION BOXES TRIBOX

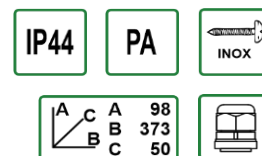

- F3.0578** TRIBOX - sockets 16A 5p, 2x32A 5p
- F3.0577** TRIBOX - sockets 2x16A 5p, 32A 5p
- F3.0575** TRIBOX - sockets 3x16A 5p
- F3.0576** TRIBOX - sockets 3x32A 5p

Box	Unit
1/1	pcs
1/1	pcs
1/1	pcs
1/1	pcs

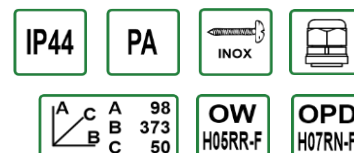

	Plug	Wire	Box	Unit
F3.0579 TRIBOX - sockets 3x16A 5p	16A 5p	/3m/ OW 5x2,5mm ²	1/1	pcs
F3.0580 TRIBOX - sockets 3x16A 5p	16A 5p	/5m/ OW 5x2,5mm ²	1/1	pcs
F3.0581 TRIBOX - sockets 3x16A 5p	16A 5p	/10m/ OW 5x2,5mm ²	1/1	pcs
F3.0582 TRIBOX - sockets 3x32A 5p	32A 5p	/3m/ OPD 5x4,0mm ²	1/1	pcs
F3.0583 TRIBOX - sockets 3x32A 5p	32A 5p	/5m/ OPD 5x4,0mm ²	1/1	pcs
F3.0584 TRIBOX - sockets 3x32A 5p	32A 5p	/10m/ OPD 5x4,0mm ²	1/1	pcs

DISTRIBUTION BOXES PARMA

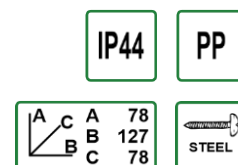

	Plug	I [A]	Box	Unit
F3.0379 PARMA - sockets 16A 5p, 2x32A 5p	16A 5p	16A	1/1	pcs
F3.0364 PARMA - sockets 2x16A 5p, 32A 5p	16A 5p	16A	1/1	pcs
F3.0112 PARMA - sockets 3x16A 5p	16A 5p	16A	1/1	pcs
F3.0113 PARMA - sockets 3x32A 5p	32A 5p	32A	1/1	pcs

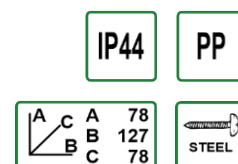

	Plug	I [A]	Box	Unit
F3.0117 PARMA - sockets 2x16A 5p, 230V	16A 5p	16A	1/1	pcs
F3.0363 PARMA - sockets 2x32A 5p, 230V	32A 5p	32A	1/1	pcs
F3.0116 PARMA - sockets 16A 5p, 2x230V	16A 5p	16A	1/1	pcs
F3.0380 PARMA - sockets 32A 5p, 2x230V	32A 5p	32A	1/1	pcs
F3.0377 PARMA - sockets 3x230V	16A 5p	16A	1/1	pcs
F3.0378 PARMA - sockets 3x230V	32A 5p	32A	1/1	pcs



		Plug	Wire	Box	Unit
F3.0381	PARMA - sockets 3x16A 5p	16A 5p	/5m/ OW 5x2,5mm ²	1/1	pcs
F3.0382	PARMA - sockets 3x16A 5p	16A 5p	/10m/ OW 5x2,5mm ²	1/1	pcs
F3.0383	PARMA - sockets 3x16A 5p	16A 5p	/15m/ OW 5x2,5mm ²	1/1	pcs
F3.0384	PARMA - sockets 3x16A 5p	16A 5p	/20m/ OW 5x2,5mm ²	1/1	pcs
F3.0385	PARMA - sockets 3x32A 5p	32A 5p	/5m/ OPD 5x4,0mm ²	1/1	pcs
F3.0386	PARMA - sockets 3x32A 5p	32A 5p	/10m/ OPD 5x4,0mm ²	1/1	pcs
F3.0387	PARMA - sockets 3x32A 5p	32A 5p	/15m/ OPD 5x4,0mm ²	1/1	pcs
F3.0388	PARMA - sockets 3x32A 5p	32A 5p	/20m/ OPD 5x4,0mm ²	1/1	pcs



		Plug	I [A]	Box	Unit
F3.0681	PARMA - sockets 3x16A 3p	16A 3p	16A	1/1	pcs
F3.0740	PARMA - sockets 2x16A 3p, 230V	16A 3p	16A	1/1	pcs
F3.0741	PARMA - sockets 16A 3p, 2x230V	16A 3p	16A	1/1	pcs
F3.0742	PARMA - sockets 3x230V	16A 3p	16A	1/1	pcs
F3.0743	PARMA - sockets 3x32A 3p	32A 3p	32A	1/1	pcs
F3.0744	PARMA - sockets 2x32A 3p, 230V	32A 3p	32A	1/1	pcs
F3.0745	PARMA - sockets 32A 3p, 2x230V	32A 3p	32A	1/1	pcs
F3.0746	PARMA - sockets 3x230V	32A 3p	32A	1/1	pcs



		Plug	Wire	Box	Unit
F3.0747	PARMA - sockets 3x16A 3p	16A 3p	/5m/ OW 3x2,5mm ²	1/1	pcs
F3.0748	PARMA - sockets 3x16A 3p	16A 3p	/10m/ OW 3x2,5mm ²	1/1	pcs
F3.0749	PARMA - sockets 3x16A 3p	16A 3p	/15m/ OW 3x2,5mm ²	1/1	pcs
F3.0750	PARMA - sockets 2x16A 3p, 230V	16A 3p	/5m/ OW 3x2,5mm ²	1/1	pcs
F3.0751	PARMA - sockets 2x16A 3p, 230V	16A 3p	/10m/ OW 3x2,5mm ²	1/1	pcs
F3.0752	PARMA - sockets 2x16A 3p, 230V	16A 3p	/15m/ OW 3x2,5mm ²	1/1	pcs



		Plug	Wire	Box	Unit
F3.0753	PARMA - sockets 16A 3p, 2x230V	16A 3p	/5m/ OW 3x2,5mm ²	1/1	pcs
F3.0754	PARMA - sockets 16A 3p, 2x230V	16A 3p	/10m/ OW 3x2,5mm ²	1/1	pcs
F3.0755	PARMA - sockets 16A 3p, 2x230V	16A 3p	/15m/ OW 3x2,5mm ²	1/1	pcs
F3.0756	PARMA - sockets 3x230V	16A 3p	/5m/ OW 3x2,5mm ²	1/1	pcs
F3.0757	PARMA - sockets 3x230V	16A 3p	/10m/ OW 3x2,5mm ²	1/1	pcs
F3.0758	PARMA - sockets 3x230V	16A 3p	/15m/ OW 3x2,5mm ²	1/1	pcs

DISTRIBUTION BOXES KOMBI

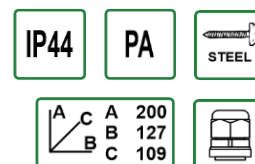

		Box	Unit
F3.0809	KOMBI - sockets 16A 3p, 230V	1/1	pcs
F3.0812	KOMBI - sockets 32A 3p, 230V	1/1	pcs
F3.0810	KOMBI - sockets 16A 3p, 2x230V	1/1	pcs
F3.0813	KOMBI - sockets 32A 3p, 2x230V	1/1	pcs
F3.0811	KOMBI - sockets 16A 3p, 3x230V	1/1	pcs
F3.0814	KOMBI - sockets 32A 3p, 3x230V	1/1	pcs
F3.0052	KOMBI - sockets 16A 5p, 230V	1/1	pcs
F3.0058	KOMBI - sockets 32A 5p, 230V	1/1	pcs
F3.0053	KOMBI - sockets 16A 5p, 2x230V	1/1	pcs
F3.0059	KOMBI - sockets 32A 5p, 2x230V	1/1	pcs
F3.0054	KOMBI - sockets 16A 5p, 3x230V	1/1	pcs
F3.0060	KOMBI - sockets 32A 5p, 3x230V	1/1	pcs

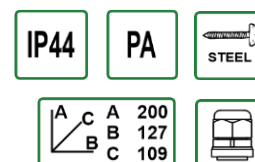

		Switch	Box	Unit
F3.0803	KOMBI - sockets 16A 3p	0-1 (16A)	1/1	pcs
F3.0806	KOMBI - sockets 32A 3p	0-1 (25A)	1/1	pcs
F3.0804	KOMBI - sockets 16A 3p, 230V	0-1 (16A)	1/1	pcs
F3.0807	KOMBI - sockets 32A 3p, 230V	0-1 (25A)	1/1	pcs
F3.0805	KOMBI - sockets 16A 3p, 2x230V	0-1 (16A)	1/1	pcs
F3.0808	KOMBI - sockets 32A 3p, 2x230V	0-1 (25A)	1/1	pcs

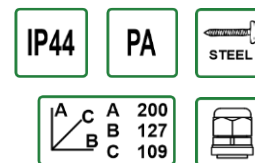

		Closing switch	Box	Unit
F3.0004	KOMBI - sockets 16A 5p	0-1 (16A)	1/1	pcs
F3.0010	KOMBI - sockets 32A 5p	0-1 (32A)	1/1	pcs
F3.0005	KOMBI - sockets 16A 5p, 230V	0-1 (16A)	1/1	pcs
F3.0011	KOMBI - sockets 32A 5p, 230V	0-1 (32A)	1/1	pcs
F3.0006	KOMBI - sockets 16A 5p, 2x230V	0-1 (16A)	1/1	pcs
F3.0012	KOMBI - sockets 32A 5p, 2x230V	0-1 (32A)	1/1	pcs
F3.0016	KOMBI - sockets 16A 5p	L/P (16A)	1/1	pcs
F3.0022	KOMBI - sockets 32A 5p	L/P (32A)	1/1	pcs
F3.0017	KOMBI - sockets 16A 5p, 230V	L/P (16A)	1/1	pcs
F3.0023	KOMBI - sockets 32A 5p, 230V	L/P (32A)	1/1	pcs
F3.0018	KOMBI - sockets 16A 5p, 2x230V	L/P (16A)	1/1	pcs
F3.0024	KOMBI - sockets 32A 5p, 2x230V	L/P (32A)	1/1	pcs

DISTRIBUTION BOXES CAJA 12M SCENIC



		IP66	Modules	Box	Unit
F3.2578	Obudowa CAJA 12M SCENIC		12 Modules	1/1	pcs
F3.2897	CAJA 12M SCENIC - sockets 16A 3p, 32A 3p, 2x230V		12 Modules	1/1	pcs
F3.2898	CAJA 12M SCENIC - sockets 2x16A 3p, 2x230V		12 Modules	1/1	pcs
F3.2899	CAJA 12M SCENIC - sockets 2x32A 3p, 2x230V		12 Modules	1/1	pcs
F3.2680	CAJA 12M SCENIC - sockets 16A 5p, 32A 5p, 2x230V		12 Modules	1/1	pcs
F3.2681	CAJA 12M SCENIC - sockets 2x16A 5p, 2x230V		12 Modules	1/1	pcs
F3.2682	CAJA 12M SCENIC - sockets 2x32A 5p, 2x230V		12 Modules	1/1	pcs



			Modules	Box	Unit
F3.2900	CAJA 12M SCENIC - sockets 16A 3p, 32A 3p, 3x230V		12 Modules	1/1	pcs
F3.2901	CAJA 12M SCENIC - sockets 2x16A 3p, 3x230V		12 Modules	1/1	pcs
F3.2902	CAJA 12M SCENIC - sockets 2x32A 3p, 3x230V		12 Modules	1/1	pcs
F3.2903	CAJA 12M SCENIC - sockets 16A 3p, 32A 3p, 4x230V		12 Modules	1/1	pcs
F3.2904	CAJA 12M SCENIC - sockets 2x16A 3p, 4x230V		12 Modules	1/1	pcs
F3.2905	CAJA 12M SCENIC - sockets 2x32A 3p, 4x230V		12 Modules	1/1	pcs
F3.2906	CAJA 12M SCENIC - sockets 16A 3p, 6x230V		12 Modules	1/1	pcs
F3.2907	CAJA 12M SCENIC - sockets 32A 3p, 6x230V		12 Modules	1/1	pcs



			Modules	Box	Unit
F3.2683	CAJA 12M SCENIC - sockets 16A 5p, 32A 5p, 3x230V		12 Modules	1/1	pcs
F3.2684	CAJA 12M SCENIC - sockets 2x16A 5p, 3x230V		12 Modules	1/1	pcs
F3.2685	CAJA 12M SCENIC - sockets 2x32A 5p, 3x230V		12 Modules	1/1	pcs
F3.2686	CAJA 12M SCENIC - sockets 16A 5p, 32A 5p, 4x230V		12 Modules	1/1	pcs
F3.2687	CAJA 12M SCENIC - sockets 2x16A 5p, 4x230V		12 Modules	1/1	pcs
F3.2688	CAJA 12M SCENIC - sockets 2x32A 5p, 4x230V		12 Modules	1/1	pcs
F3.2689	CAJA 12M SCENIC - sockets 16A 5p, 6x230V		12 Modules	1/1	pcs
F3.2690	CAJA 12M SCENIC - sockets 32A 5p, 6x230V		12 Modules	1/1	pcs



			Modules	Box	Unit
F3.2691	CAJA 12M SCENIC - sockets 6x230V		12 Modules	1/1	pcs
F3.2692	CAJA 12M SCENIC - sockets 8x230V		12 Modules	1/1	pcs

DISTRIBUTION BOXES LAGO 10M SCENIC

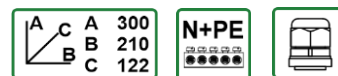

Panel Mounted Socket

		IP66	Modules	Box	Unit
F3.2577	Obudowa LAGO 10M SCENIC		10 Modules	1/1	pcs
F3.2887	LAGO 10M SCENIC - sockets 16A 3p, 32A 3p		10 Modules	1/1	pcs
F3.2888	LAGO 10M SCENIC - sockets 2x16A 3p		10 Modules	1/1	pcs
F3.2889	LAGO 10M SCENIC - sockets 2x32A 3p		10 Modules	1/1	pcs
F3.2660	LAGO 10M SCENIC - sockets 16A 5p, 32A 5p		10 Modules	1/1	pcs
F3.2661	LAGO 10M SCENIC - sockets 2x16A 5p		10 Modules	1/1	pcs
F3.2662	LAGO 10M SCENIC - sockets 2x32A 5p		10 Modules	1/1	pcs
F3.2669	LAGO 10M SCENIC - sockets 6x230V		10 Modules	1/1	pcs



Panel Mounted Socket

			Modules	Box	Unit
F3.2890	LAGO 10M SCENIC - sockets 16A 3p, 2x230V		10 Modules	1/1	pcs
F3.2891	LAGO 10M SCENIC - sockets 32A 3p, 2x230V		10 Modules	1/1	pcs
F3.2892	LAGO 10M SCENIC - sockets 16A 3p, 3x230V		10 Modules	1/1	pcs
F3.2893	LAGO 10M SCENIC - sockets 32A 3p, 3x230V		10 Modules	1/1	pcs
F3.2894	LAGO 10M SCENIC - sockets 16A 3p, 4x230V		10 Modules	1/1	pcs
F3.2895	LAGO 10M SCENIC - sockets 32A 3p, 4x230V		10 Modules	1/1	pcs



Panel Mounted Socket

			Modules	Box	Unit
F3.2663	LAGO 10M SCENIC - sockets 16A 5p, 2x230V		10 Modules	1/1	pcs
F3.2664	LAGO 10M SCENIC - sockets 32A 5p, 2x230V		10 Modules	1/1	pcs
F3.2665	LAGO 10M SCENIC - sockets 16A 5p, 3x230V		10 Modules	1/1	pcs
F3.2666	LAGO 10M SCENIC - sockets 32A 5p, 3x230V		10 Modules	1/1	pcs
F3.2667	LAGO 10M SCENIC - sockets 16A 5p, 4x230V		10 Modules	1/1	pcs
F3.2668	LAGO 10M SCENIC - sockets 32A 5p, 4x230V		10 Modules	1/1	pcs

DISTRIBUTION BOXES R-240 4M

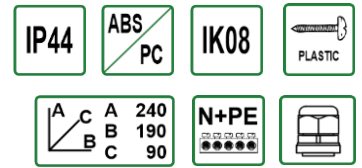

Code	Description	IP	Modules	Box	Unit
F3.0265	Distributon box R-240 4M	IP65	4 Modules	1/1	pcs
F3.0069	R-240 4M - sockets 16A 5p, 32A 5p, 2x230V		4 Modules	1/1	pcs
F3.0073	R-240 4M - sockets 2x16A 5p, 2x230V		4 Modules	1/1	pcs
F3.0071	R-240 4M - sockets 2x32A 5p, 2x230V		4 Modules	1/1	pcs

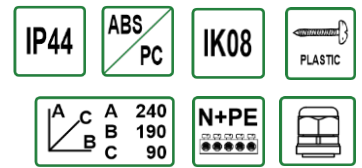

Code	Description	IP	Modules	Box	Unit
F3.0786	R-240 4M - sockets 16A 5p, 4x230V		4 Modules	1/1	pcs
F3.0787	R-240 4M - sockets 32A 5p, 4x230V		4 Modules	1/1	pcs
F3.0522	R-240 4M - sockets 6x230V		4 Modules	1/1	pcs

DISTRIBUTION BOXES R-240 8M

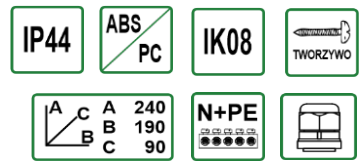

Code	Description	IP	Modules	Box	Unit
F3.0266	Distributon box R-240 8M	IP65	8 Modules	1/1	pcs
F3.0077	R-240 8M - sockets 16A 5p, 32A 5p		8 Modules	1/1	pcs
F3.0081	R-240 8M - sockets 2x16A 5p		8 Modules	1/1	pcs
F3.0079	R-240 8M - sockets 2x32A 5p		8 Modules	1/1	pcs

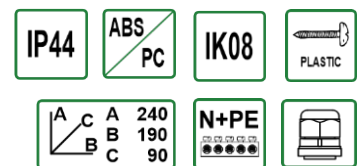

Code	Description	IP	Modules	Box	Unit
F3.0075	R-240 8M - sockets 16A 5p, 2x230V		8 Modules	1/1	pcs
F3.0076	R-240 8M - sockets 32A 5p, 2x230V		8 Modules	1/1	pcs
F3.0119	R-240 8M - sockets 2x16A 5p, 2x230V		8 Modules	1/1	pcs
F3.0120	R-240 8M - sockets 2x32A 5p, 2x230V		8 Modules	1/1	pcs
F3.0118	R-240 8M - sockets 16A 5p, 32A 5p, 2x230V		8 Modules	1/1	pcs
F3.0288	R-240 8M - sockets 4x230V		8 Modules	1/1	pcs

DISTRIBUTION BOXES CAJA 9M

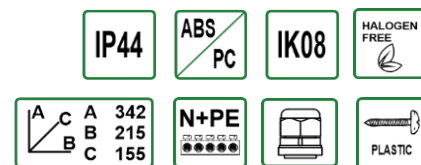

		IP65	Modules	Box	Unit
F3.0267	Distributon box CAJA 9M		9 Modules	1/1	pcs
F3.0245	CAJA 9M - sockets 16A 5p, 32A 5p, 2x230V		9 Modules	1/1	pcs
F3.0250	CAJA 9M - sockets 2x16A 5p, 2x230V		9 Modules	1/1	pcs
F3.0251	CAJA 9M - sockets 2x32A 5p, 2x230V		9 Modules	1/1	pcs

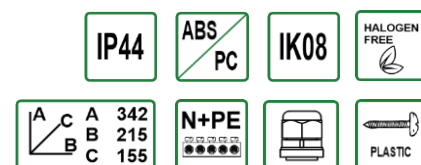

			Modules	Box	Unit
F3.0130	CAJA 9M - sockets 16A 5p, 32A 5p, 3x230V		9 Modules	1/1	pcs
F3.0132	CAJA 9M - sockets 2x16A 5p, 3x230V		9 Modules	1/1	pcs
F3.0131	CAJA 9M - sockets 2x32A 5p, 3x230V		9 Modules	1/1	pcs

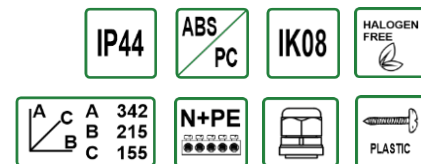

		Switch	Modules	Box	Unit
F3.0133	CAJA 9M - sockets 16A 5p, 32A 5p, 2x230V	0-1 (32A)	9 Modules	1/1	pcs
F3.0246	CAJA 9M - sockets 2x16A 5p, 2x230V	0-1 (32A)	9 Modules	1/1	pcs
F3.0248	CAJA 9M - sockets 2x32A 5p, 2x230V	0-1 (32A)	9 Modules	1/1	pcs

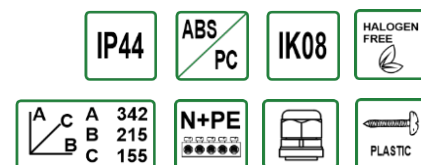

		Switch	Modules	Box	Unit
F3.0134	CAJA 9M - sockets 16A 5p, 32A 5p, 2x230V	L/P (32A)	9 Modules	1/1	pcs
F3.0247	CAJA 9M - sockets 2x16A 5p, 2x230V	L/P (32A)	9 Modules	1/1	pcs
F3.0249	CAJA 9M - sockets 2x32A 5p, 2x230V	L/P (32A)	9 Modules	1/1	pcs

DISTRIBUTION BOXES CAJA 11M



		Modules	Box	Unit
F3.0411	Distributon box CAJA 11M	11 Modules	1/1	pcs
F3.0396	CAJA 11M - sockets 16A 5p, 3x32A 5p	11 Modules	1/1	pcs
F3.0394	CAJA 11M - sockets 2x16A 5p, 2x32A 5p	11 Modules	1/1	pcs
F3.0395	CAJA 11M - sockets 3x16A 5p, 32A 5p	11 Modules	1/1	pcs
F3.0392	CAJA 11M - sockets 4x16A 5p	11 Modules	1/1	pcs
F3.0393	CAJA 11M - sockets 4x32A 5p	11 Modules	1/1	pcs



		Modules	Box	Unit
F3.0400	CAJA 11M - sockets 16A 5p, 32A 5p, 3x230V	11 Modules	1/1	pcs
F3.0401	CAJA 11M - sockets 2x16A 5p, 3x230V	11 Modules	1/1	pcs
F3.0402	CAJA 11M - sockets 2x32A 5p, 3x230V	11 Modules	1/1	pcs
F3.0397	CAJA 11M - sockets 16A 5p, 32A 5p, 4x230V	11 Modules	1/1	pcs
F3.0398	CAJA 11M - sockets 2x16A 5p, 4x230V	11 Modules	1/1	pcs
F3.0399	CAJA 11M - sockets 2x32A 5p, 4x230V	11 Modules	1/1	pcs



		Modules	Box	Unit
F3.0403	CAJA 11M - sockets 3x16A 5p, 2x230V	11 Modules	1/1	pcs
F3.0404	CAJA 11M - sockets 3x32A 5p, 2x230V	11 Modules	1/1	pcs



		Funkcja	Modules	Box	Unit
F3.0405	CAJA 11M - sockets 16A 5p, 32A 5p, 2x230V	0-1 (32A)	11 Modules	1/1	pcs
F3.0407	CAJA 11M - sockets 2x16A 5p, 2x230V	0-1 (32A)	11 Modules	1/1	pcs
F3.0409	CAJA 11M - sockets 2x32A 5p, 2x230V	0-1 (32A)	11 Modules	1/1	pcs
F3.0406	CAJA 11M - sockets 16A 5p, 32A 5p, 2x230V	L/P (32A)	11 Modules	1/1	pcs
F3.0408	CAJA 11M - sockets 2x16A 5p, 2x230V	L/P (32A)	11 Modules	1/1	pcs
F3.0410	CAJA 11M - sockets 2x32A 5p, 2x230V	L/P (32A)	11 Modules	1/1	pcs

DISTRIBUTION BOXES CAJA 12M



IP44	ABS PC	IK08	INOX												
<table border="1"> <tr><td>A</td><td>C</td><td>A</td><td>330</td></tr> <tr><td>B</td><td></td><td>B</td><td>240</td></tr> <tr><td></td><td></td><td>C</td><td>140</td></tr> </table>	A	C	A	330	B		B	240			C	140	N+PE		
A	C	A	330												
B		B	240												
		C	140												

		IP66	Modules	Box	Unit
F3.0570	Distributon box CAJA 12M		12 Modules	1/1	pcs
F3.0450	CAJA 12M - sockets 16A 5p, 32A 5p, 2x230V		12 Modules	1/1	pcs
F3.0452	CAJA 12M - sockets 2x16A 5p, 2x230V		12 Modules	1/1	pcs
F3.0455	CAJA 12M - sockets 2x32A 5p, 2x230V		12 Modules	1/1	pcs



IP44	ABS PC	IK08	INOX												
<table border="1"> <tr><td>A</td><td>C</td><td>A</td><td>330</td></tr> <tr><td>B</td><td></td><td>B</td><td>240</td></tr> <tr><td></td><td></td><td>C</td><td>140</td></tr> </table>	A	C	A	330	B		B	240			C	140	N+PE		
A	C	A	330												
B		B	240												
		C	140												

			Modules	Box	Unit
F3.0444	CAJA 12M - sockets 16A 5p, 32A 5p, 3x230V		12 Modules	1/1	pcs
F3.0453	CAJA 12M - sockets 2x16A 5p, 3x230V		12 Modules	1/1	pcs
F3.0456	CAJA 12M - sockets 2x32A 5p, 3x230V		12 Modules	1/1	pcs



IP44	ABS PC	IK08	INOX												
<table border="1"> <tr><td>A</td><td>C</td><td>A</td><td>330</td></tr> <tr><td>B</td><td></td><td>B</td><td>240</td></tr> <tr><td></td><td></td><td>C</td><td>140</td></tr> </table>	A	C	A	330	B		B	240			C	140	N+PE		
A	C	A	330												
B		B	240												
		C	140												

			Modules	Box	Unit
F3.0451	CAJA 12M - sockets 16A 5p, 32A 5p, 4x230V		12 Modules	1/1	pcs
F3.0454	CAJA 12M - sockets 2x16A 5p, 4x230V		12 Modules	1/1	pcs
F3.0457	CAJA 12M - sockets 2x32A 5p, 4x230V		12 Modules	1/1	pcs



IP44	ABS PC	IK08	INOX												
<table border="1"> <tr><td>A</td><td>C</td><td>A</td><td>330</td></tr> <tr><td>B</td><td></td><td>B</td><td>240</td></tr> <tr><td></td><td></td><td>C</td><td>140</td></tr> </table>	A	C	A	330	B		B	240			C	140	N+PE		
A	C	A	330												
B		B	240												
		C	140												

			Modules	Box	Unit
F3.1824	CAJA 12M - sockets 16A 5p, 6x230V		12 Modules	1/1	pcs
F3.1218	CAJA 12M - sockets 32A 5p, 6x230V		12 Modules	1/1	pcs



IP44	ABS PC	IK08	INOX												
<table border="1"> <tr><td>A</td><td>C</td><td>A</td><td>330</td></tr> <tr><td>B</td><td></td><td>B</td><td>240</td></tr> <tr><td></td><td></td><td>C</td><td>140</td></tr> </table>	A	C	A	330	B		B	240			C	140	N+PE		
A	C	A	330												
B		B	240												
		C	140												

			Modules	Box	Unit
F3.1825	CAJA 12M - sockets 6x230V		12 Modules	1/1	pcs
F3.0464	CAJA 12M - sockets 8x230V		12 Modules	1/1	pcs

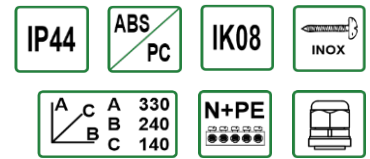

- F3.0833** CAJA 12M - sockets 16A 5p, 63A 5p, 2x230V
- F3.0834** CAJA 12M - sockets 16A 5p, 63A 5p, 3x230V
- F3.0835** CAJA 12M - sockets 16A 5p, 63A 5p, 4x230V

Modules	Box	Unit
12 Modules	1/1	pcs
12 Modules	1/1	pcs
12 Modules	1/1	pcs

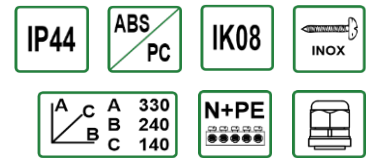

- F3.0836** CAJA 12M - sockets 32A 5p, 63A 5p, 2x230V
- F3.0837** CAJA 12M - sockets 32A 5p, 63A 5p, 3x230V
- F3.0838** CAJA 12M - sockets 32A 5p, 63A 5p, 4x230V

Modules	Box	Unit
12 Modules	1/1	pcs
12 Modules	1/1	pcs
12 Modules	1/1	pcs

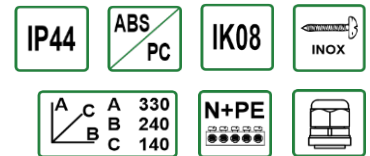

- F3.0458** CAJA 12M - sockets 16A 5p, 32A 5p, 2x230V
- F3.0459** CAJA 12M - sockets 2x16A 5p, 2x230V
- F3.0460** CAJA 12M - sockets 2x32A 5p, 2x230V

Switch	Modules	Box	Unit
0-1 (32A)	12 Modules	1/1	pcs
0-1 (32A)	12 Modules	1/1	pcs
0-1 (32A)	12 Modules	1/1	pcs

- F3.0461** CAJA 12M - sockets 16A 5p, 32A 5p, 2x230V
- F3.0462** CAJA 12M - sockets 2x16A 5p, 2x230V
- F3.0463** CAJA 12M - sockets 2x32A 5p, 2x230V

Switch	Modules	Box	Unit
L/P (32A)	12 Modules	1/1	pcs
L/P (32A)	12 Modules	1/1	pcs
L/P (32A)	12 Modules	1/1	pcs

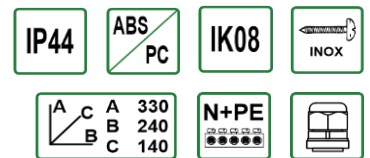

- F3.0839** CAJA 12M - sockets 16A 5p, 63A 5p, 2x230V
- F3.0841** CAJA 12M - sockets 32A 5p, 63A 5p, 2x230V

Switch	Modules	Box	Unit
0-1 (63A)	12 Modules	1/1	pcs
0-1 (63A)	12 Modules	1/1	pcs

- F3.0840** CAJA 12M - sockets 16A 5p, 63A 5p, 2x230V
- F3.0842** CAJA 12M - sockets 32A 5p, 63A 5p, 2x230V

Switch	Modules	Box	Unit
L/P (63A)	12 Modules	1/1	pcs
L/P (63A)	12 Modules	1/1	pcs

DISTRIBUTION BOXES CAJA 12M BICOLOR



IP44 ABS/PC IK08 INOX

A C A 330
B B 240
C C 140

N+PE

- F3.2693 CAJA 12M BICOLOR - sockets 16A 5p, 32A 5p, 2x230V
- F3.2694 CAJA 12M BICOLOR - sockets 2x16A 5p, 2x230V
- F3.2695 CAJA 12M BICOLOR - sockets 2x32A 5p, 2x230V

Modules	Box	Unit
12 Modules	1/1	pcs
12 Modules	1/1	pcs
12 Modules	1/1	pcs



IP44 ABS/PC IK08 INOX

A C A 330
B B 240
C C 140

N+PE

- F3.2696 CAJA 12M BICOLOR - sockets 16A 5p, 32A 5p, 3x230V
- F3.2697 CAJA 12M BICOLOR - sockets 2x16A 5p, 3x230V
- F3.2698 CAJA 12M BICOLOR - sockets 2x32A 5p, 3x230V

Modules	Box	Unit
12 Modules	1/1	pcs
12 Modules	1/1	pcs
12 Modules	1/1	pcs



IP44 ABS/PC IK08 INOX

A C A 330
B B 240
C C 140

N+PE

- F3.2699 CAJA 12M BICOLOR - sockets 16A 5p, 32A 5p, 4x230V
- F3.2700 CAJA 12M BICOLOR - sockets 2x16A 5p, 4x230V
- F3.2701 CAJA 12M BICOLOR - sockets 2x32A 5p, 4x230V

Modules	Box	Unit
12 Modules	1/1	pcs
12 Modules	1/1	pcs
12 Modules	1/1	pcs



IP44 ABS/PC IK08 INOX

A C A 330
B B 240
C C 140

N+PE

- F3.2702 CAJA 12M BICOLOR - sockets 16A 5p, 6x230V
- F3.2703 CAJA 12M BICOLOR - sockets 32A 5p, 6x230V

Modules	Box	Unit
12 Modules	1/1	pcs
12 Modules	1/1	pcs



IP44 ABS/PC IK08 INOX

A C A 330
B B 240
C C 140

N+PE

- F3.2704 CAJA 12M BICOLOR - sockets 6x230V
- F3.2705 CAJA 12M BICOLOR - sockets 8x230V

Modules	Box	Unit
12 Modules	1/1	pcs
12 Modules	1/1	pcs

DISTRIBUTION BOXES CAJA 12M BICOLOR



IP44 ABS/PC IK08 INOX

A C 330
B 240
C 140

N+PE

		Modules	Box	Unit
F3.2706	CAJA 12M BICOLOR - sockets 16A 5p, 63A 5p, 2x230V	12 Modules	1/1	pcs
F3.2707	CAJA 12M BICOLOR - sockets 16A 5p, 63A 5p, 3x230V	12 Modules	1/1	pcs
F3.2708	CAJA 12M BICOLOR - sockets 16A 5p, 63A 5p, 4x230V	12 Modules	1/1	pcs



IP44 ABS/PC IK08 INOX

A C 330
B 240
C 140

N+PE

		Modules	Box	Unit
F3.2709	CAJA 12M BICOLOR - sockets 32A 5p, 63A 5p, 2x230V	12 Modules	1/1	pcs
F3.2710	CAJA 12M BICOLOR - sockets 32A 5p, 63A 5p, 3x230V	12 Modules	1/1	pcs
F3.2711	CAJA 12M BICOLOR - sockets 32A 5p, 63A 5p, 4x230V	12 Modules	1/1	pcs



IP44 ABS/PC IK08 INOX

A C 330
B 240
C 140

N+PE

		Switch	Modules	Box	Unit
F3.2712	CAJA 12M BICOLOR - sockets 16A 5p, 32A 5p, 2x230V	0-1 (32A)	12 Modules	1/1	pcs
F3.2713	CAJA 12M BICOLOR - sockets 2x16A 5p, 2x230V	0-1 (32A)	12 Modules	1/1	pcs
F3.2714	CAJA 12M BICOLOR - sockets 2x32A 5p, 2x230V	0-1 (32A)	12 Modules	1/1	pcs
F3.2715	CAJA 12M BICOLOR - sockets 16A 5p, 32A 5p, 2x230V	L/P (32A)	12 Modules	1/1	pcs
F3.2716	CAJA 12M BICOLOR - sockets 2x16A 5p, 2x230V	L/P (32A)	12 Modules	1/1	pcs
F3.2717	CAJA 12M BICOLOR - sockets 2x32A 5p, 2x230V	L/P (32A)	12 Modules	1/1	pcs



IP44 ABS/PC IK08 INOX

A C 330
B 240
C 140

N+PE

		Funkcja wyłącznika	Modules	Box	Unit
F3.2718	CAJA 12M BICOLOR - sockets 16A 5p, 63A 5p, 2x230V	0-1 (63A)	12 Modules	1/1	pcs
F3.2719	CAJA 12M BICOLOR - sockets 32A 5p, 63A 5p, 2x230V	0-1 (63A)	12 Modules	1/1	pcs
F3.2720	CAJA 12M BICOLOR - sockets 16A 5p, 63A 5p, 2x230V	L/P (63A)	12 Modules	1/1	pcs
F3.2721	CAJA 12M BICOLOR - sockets 32A 5p, 63A 5p, 2x230V	L/P (63A)	12 Modules	1/1	pcs

DISTRIBUTION BOXES CAJA 15M



IP44	ABS PC	IK08	INOX
A C B	A 300 B 325 C 140	N+PE	

		IP65	Modules	Box	Unit
F3.2856	Distributon box CAJA 15M		15 Modules	1/1	pcs
F3.2865	CAJA 15M - sockets 3x16A 5p, 3x230V		15 Modules	1/1	pcs
F3.2866	CAJA 15M - sockets 2x16A 5p, 32A 5p, 3x230V		15 Modules	1/1	pcs
F3.2867	CAJA 15M - sockets 16A 5p, 2x32A 5p, 3x230V		15 Modules	1/1	pcs
F3.2868	CAJA 15M - sockets 3x32A 5p, 3x230V		15 Modules	1/1	pcs



IP44	ABS PC	IK08	INOX
A C B	A 300 B 325 C 140	N+PE	

			Modules	Box	Unit
F3.2869	CAJA 15M - sockets 3x16A 5p, 4x230V		15 Modules	1/1	pcs
F3.2870	CAJA 15M - sockets 2x16A 5p, 32A 5p, 4x230V		15 Modules	1/1	pcs
F3.2871	CAJA 15M - sockets 16A 5p, 2x32A 5p, 4x230V		15 Modules	1/1	pcs
F3.2872	CAJA 15M - sockets 3x32A 5p, 4x230V		15 Modules	1/1	pcs
F3.2873	CAJA 15M - sockets 3x16A 5p, 5x230V		15 Modules	1/1	pcs
F3.2874	CAJA 15M - sockets 2x16A 5p, 32A 5p, 5x230V		15 Modules	1/1	pcs
F3.2875	CAJA 15M - sockets 16A 5p, 2x32A 5p, 5x230V		15 Modules	1/1	pcs
F3.2876	CAJA 15M - sockets 3x32A 5p, 5x230V		15 Modules	1/1	pcs



IP44	ABS PC	IK08	INOX
A C B	A 300 B 325 C 140	N+PE	

			Moduly	Op.	J.m.
F3.2877	CAJA 15M - sockets 16A 5p, 63A 5p, 3x230V		15 Modules	1/1	pcs
F3.2878	CAJA 15M - sockets 32A 5p, 63A 5p, 3x230V		15 Modules	1/1	pcs
F3.2879	CAJA 15M - sockets 16A 5p, 63A 5p, 4x230V		15 Modules	1/1	pcs
F3.2880	CAJA 15M - sockets 32A 5p, 63A 5p, 4x230V		15 Modules	1/1	pcs
F3.2881	CAJA 15M - sockets 16A 5p, 63A 5p, 5x230V		15 Modules	1/1	pcs
F3.2882	CAJA 15M - sockets 32A 5p, 63A 5p, 5x230V		15 Modules	1/1	pcs



IP44	ABS PC	IK08	INOX
A C B	A 300 B 325 C 140	N+PE	

			Modules	Box	Unit
F3.2883	CAJA 15M - sockets 2x63A 5p, 3x230V		15 Modules	1/1	pcs
F3.2884	CAJA 15M - sockets 2x63A 5p, 4x230V		15 Modules	1/1	pcs
F3.2885	CAJA 15M - gniazda 2x63A 5p, 5x230V		15 Modules	1/1	pcs

DISTRIBUTION BOXES CAJA 26M

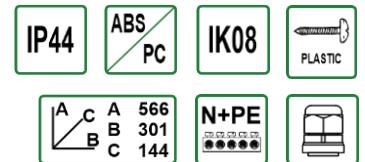

		Modules	Box	Unit
F3.0817	CAJA 26M - sockets 16A 5p, 2x32A 5p, 8x230V	26 Modules	1/1	pcs
F3.0818	CAJA 26M - sockets 2x16A 5p, 32A 5p, 8x230V	26 Modules	1/1	pcs
F3.0815	CAJA 26M - sockets 3x16A 5p, 8x230V	26 Modules	1/1	pcs
F3.0816	CAJA 26M - sockets 3x32A 5p, 8x230V	26 Modules	1/1	pcs
F3.0821	CAJA 26M - sockets 16A 5p, 2x32A 5p, 10x230V	26 Modules	1/1	pcs
F3.0822	CAJA 26M - sockets 2x16A 5p, 32A 5p, 10x230V	26 Modules	1/1	pcs
F3.0819	CAJA 26M - sockets 3x16A 5p, 10x230V	26 Modules	1/1	pcs
F3.0820	CAJA 26M - sockets 3x32A 5p, 10x230V	26 Modules	1/1	pcs

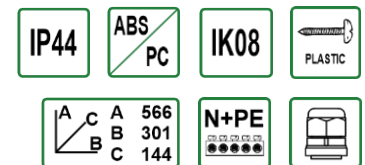

		Modules	Box	Unit
F3.0825	CAJA 26M - sockets 16A 5p, 3x32A 5p, 4x230V	26 Modules	1/1	pcs
F3.0826	CAJA 26M - sockets 2x16A 5p, 2x32A 5p, 4x230V	26 Modules	1/1	pcs
F3.0827	CAJA 26M - sockets 3x16A 5p, 32A 5p, 4x230V	26 Modules	1/1	pcs
F3.0823	CAJA 26M - sockets 4x16A 5p, 4x230V	26 Modules	1/1	pcs
F3.0824	CAJA 26M - sockets 4x32A 5p, 4x230V	26 Modules	1/1	pcs
F3.0830	CAJA 26M - sockets 16A 5p, 3x32A 5p, 6x230V	26 Modules	1/1	pcs
F3.0831	CAJA 26M - sockets 2x16A 5p, 2x32A 5p, 6x230V	26 Modules	1/1	pcs
F3.0832	CAJA 26M - sockets 3x16A 5p, 32A 5p, 6x230V	26 Modules	1/1	pcs
F3.0828	CAJA 26M - sockets 4x16A 5p, 6x230V	26 Modules	1/1	pcs
F3.0829	CAJA 26M - sockets 4x32A 5p, 6x230V	26 Modules	1/1	pcs

DISTRIBUTION BOXES ULISSE 6M MINI

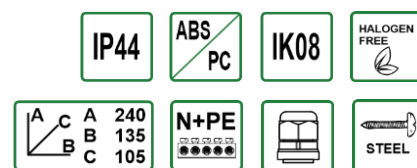

Code	Description	IP	Modules	Box	Unit
74180.40	Distributon box ULISSE 6M MINI	IP54	6 Modules	1/1	pcs
74180.20	ULISSE 6M MINI - sockets 2x230V		6 Modules	1/1	pcs
74180.35	ULISSE 6M MINI - sockets 4x230V		6 Modules	1/1	pcs

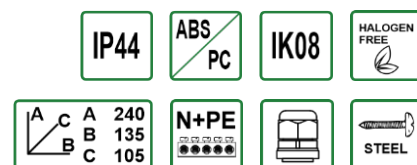

Code	Description	IP	Modules	Box	Unit
74180.33	ULISSE 6M MINI - sockets 16A 5p		6 Modules	1/1	pcs
74180.34	ULISSE 6M MINI - sockets 32A 5p		6 Modules	1/1	pcs
74180.36	ULISSE 6M MINI - sockets 16A 5p, 230V		6 Modules	1/1	pcs
74180.37	ULISSE 6M MINI - sockets 32A 5p, 230V		6 Modules	1/1	pcs
74180.38	ULISSE 6M MINI - sockets 16A 5p, 2x230V		6 Modules	1/1	pcs
74180.39	ULISSE 6M MINI - sockets 32A 5p, 2x230V		6 Modules	1/1	pcs

DISTRIBUTION BOXES ULISSE 6M MIDI

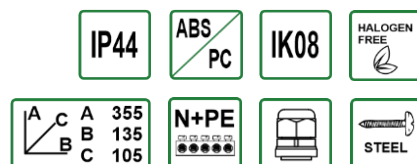

Code	Description	IP	Modules	Box	Unit
74180.41	Distributon box ULISSE 6M MIDI	IP54	6 Modules	1/1	pcs
74180.9	ULISSE 6M MIDI - sockets 4x230V		6 Modules	1/1	pcs
74180.4	ULISSE 6M MIDI - sockets 6x230V		6 Modules	1/1	pcs

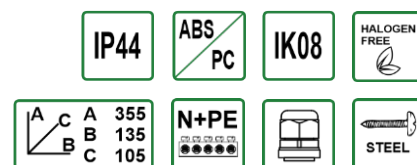

Code	Description	IP	Modules	Box	Unit
74180.0	ULISSE 6M MIDI - sockets 16A 5p, 2x230V		6 Modules	1/1	pcs
74180.1	ULISSE 6M MIDI - sockets 32A 5p, 2x230V		6 Modules	1/1	pcs
74180.3	ULISSE 6M MIDI - sockets 16A 5p, 4x230V		6 Modules	1/1	pcs
74180.6	ULISSE 6M MIDI - sockets 32A 5p, 4x230V		6 Modules	1/1	pcs

DISTRIBUTION BOXES ULISSE 6M MAXI

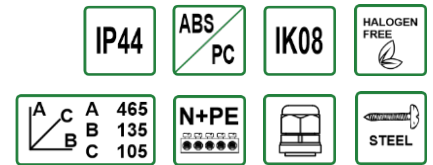

		IP54	Modules	Box	Unit
74180	Distributon box ULISSE 6M MAXI		6 Modules	1/1	pcs
74180.31	ULISSE 6M MAXI - sockets 6x230V		6 Modules	1/1	pcs
74180.32	ULISSE 6M MAXI - sockets 8x230V		6 Modules	1/1	pcs

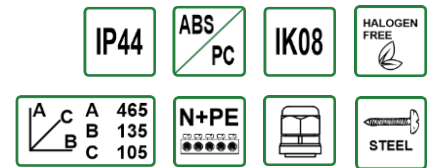

		IP54	Modules	Box	Unit
74180.2	ULISSE 6M MAXI - sockets 16A 5p, 32A 5p		6 Modules	1/1	pcs
74180.8	ULISSE 6M MAXI - sockets 16A 5p, 32A 5p, 2x230V		6 Modules	1/1	pcs
74180.21	ULISSE 6M MAXI - sockets 2x16A 5p, 2x230V		6 Modules	1/1	pcs
74180.22	ULISSE 6M MAXI - sockets 2x32A 5p, 2x230V		6 Modules	1/1	pcs

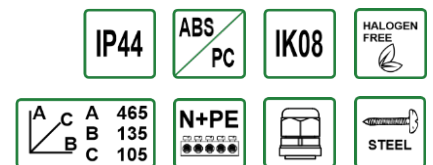

		IP54	Modules	Box	Unit
74180.29	ULISSE 6M MAXI - sockets 16A 5p, 4x230V		6 Modules	1/1	pcs
74180.30	ULISSE 6M MAXI - sockets 32A 5p, 4x230V		6 Modules	1/1	pcs

DISTRIBUTION BOXES ULISSE 11M

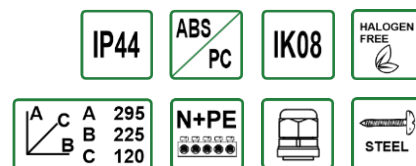

Code	Description	IP	Modules	Box	Unit
74184	Distributon box ULISSE 11M	IP54	11 Modules	1/1	pcs
74184.1	ULISSE 11M - sockets 16A 5p, 32A 5p		11 Modules	1/1	pcs
74184.2	ULISSE 11M - sockets 2x16A 5p		11 Modules	1/1	pcs
74184.3	ULISSE 11M - sockets 2x32A 5p		11 Modules	1/1	pcs

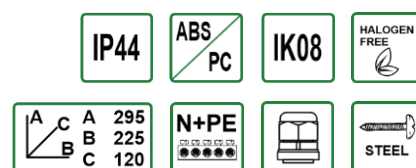

Code	Description	Modules	Box	Unit
74184.4	ULISSE 11M - sockets 16A 5p, 2x230V	11 Modules	1/1	pcs
74184.5	ULISSE 11M - sockets 32A 5p, 2x230V	11 Modules	1/1	pcs
74184.6	ULISSE 11M - sockets 16A 5p, 32A 5p, 2x230V	11 Modules	1/1	pcs
74184.7	ULISSE 11M - sockets 2x16A 5p, 2x230V	11 Modules	1/1	pcs
74184.8	ULISSE 11M - sockets 2x32A 5p, 2x230V	11 Modules	1/1	pcs

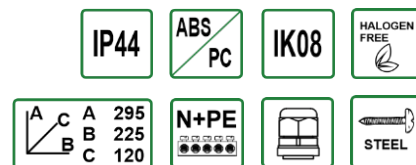

Code	Description	Modules	Box	Unit
74184.9	ULISSE 11M - sockets 16A 5p, 3x230V	11 Modules	1/1	pcs
74184.10	ULISSE 11M - sockets 32A 5p, 3x230V	11 Modules	1/1	pcs
74184.11	ULISSE 11M - sockets 16A 5p, 4x230V	11 Modules	1/1	pcs
74184.12	ULISSE 11M - sockets 32A 5p, 4x230V	11 Modules	1/1	pcs

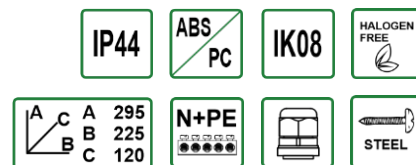

Code	Description	Modules	Box	Unit
74184.13	ULISSE 11M - sockets 6x230V	11 Modules	1/1	pcs

DISTRIBUTION BOXES ULISSE 12M

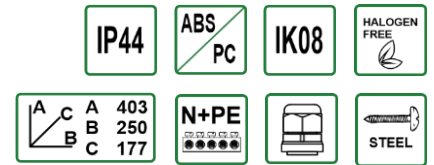

		IP65	Modules	Box	Unit
74181	Distributon box ULISSE 12M		12 Modules	1/1	pcs
74181.4	ULISSE 12M - sockets 16A 5p, 32A 5p, 2x230V		12 Modules	1/1	pcs
74181.48	ULISSE 12M - sockets 2x16A 5p, 2x230V		12 Modules	1/1	pcs
74181.73	ULISSE 12M - sockets 2x32A 5p, 2x230V		12 Modules	1/1	pcs

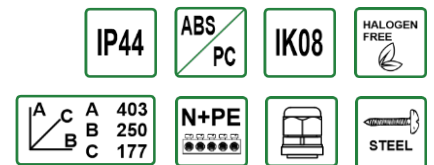

			Modules	Box	Unit
74181.0	ULISSE 12M - sockets 16A 5p, 32A 5p, 3x230V		12 Modules	1/1	pcs
74181.1	ULISSE 12M - sockets 2x16A 5p, 3x230V		12 Modules	1/1	pcs
74181.2	ULISSE 12M - sockets 2x32A 5p, 3x230V		12 Modules	1/1	pcs
74181.6	ULISSE 12M - sockets 16A 5p, 32A 5p, 4x230V		12 Modules	1/1	pcs
74181.54	ULISSE 12M - sockets 2x16A 5p, 4x230V		12 Modules	1/1	pcs
74181.43	ULISSE 12M - sockets 2x32A 5p, 4x230V		12 Modules	1/1	pcs

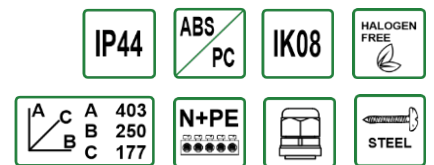

			Modules	Box	Unit
74181.3	ULISSE 12M - sockets 9x230V		12 Modules	1/1	pcs

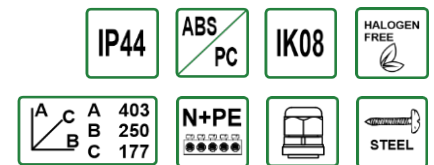

			Modules	Box	Unit
74181.169	ULISSE 12M - sockets 16A 5p, 63A 5p, 2x230V		12 Modules	1/1	pcs
74181.19	ULISSE 12M - sockets 32A 5p, 63A 5p, 2x230V		12 Modules	1/1	pcs
74181.170	ULISSE 12M - sockets 16A 5p, 63A 5p, 3x230V		12 Modules	1/1	pcs
74181.171	ULISSE 12M - sockets 32A 5p, 63A 5p, 3x230V		12 Modules	1/1	pcs

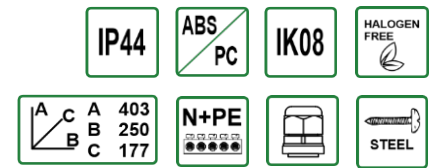

	Switch	Modules	Box	Unit
74181.13 ULISSE 12M - sockets 16A 5p, 32A 5p, 2x230V	0-1 (32A)	12 Modules	1/1	pcs
74181.91 ULISSE 12M - sockets 2x16A 5p, 2x230V	0-1 (32A)	12 Modules	1/1	pcs
74181.93 ULISSE 12M - sockets 2x32A 5p, 2x230V	0-1 (32A)	12 Modules	1/1	pcs
74181.10 ULISSE 12M - sockets 16A 5p, 32A 5p, 2x230V	L/P (32A)	12 Modules	1/1	pcs
74181.92 ULISSE 12M - sockets 2x16A 5p, 2x230V	L/P (32A)	12 Modules	1/1	pcs
74181.7 ULISSE 12M - sockets 2x32A 5p, 2x230V	L/P (32A)	12 Modules	1/1	pcs

DISTRIBUTION BOXES ULISSE 17M

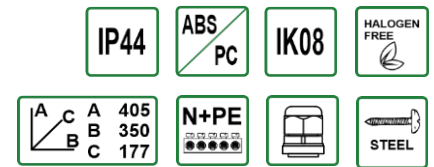

	Switch	Modules	Box	Unit
74182 Distributon box ULISSE 17M	IP65	17 Modules	1/1	pcs
74182.1 ULISSE 17M - sockets 16A 5p, 2x32A 5p, 4x230V		17 Modules	1/1	pcs
74182.0 ULISSE 17M - sockets 2x16A 5p, 32A 5p, 4x230V		17 Modules	1/1	pcs
74182.2 ULISSE 17M - sockets 3x16A 5p, 4x230V		17 Modules	1/1	pcs
74182.3 ULISSE 17M - sockets 3x32A 5p, 4x230V		17 Modules	1/1	pcs

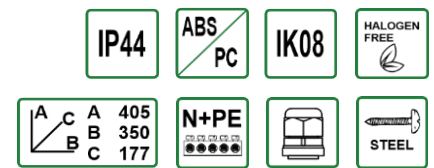

	Switch	Modules	Box	Unit
74182.225 ULISSE 17M - sockets 16A 5p, 3x32A 5p, 4x230V		17 Modules	1/1	pcs
74182.4 ULISSE 17M - sockets 2x16A 5p, 2x32A 5p, 4x230V		17 Modules	1/1	pcs
74182.135 ULISSE 17M - sockets 3x16A 5p, 32A 5p, 4x230V		17 Modules	1/1	pcs
74182.25 ULISSE 17M - sockets 4x16A 5p, 4x230V		17 Modules	1/1	pcs
74182.59 ULISSE 17M - sockets 4x32A 5p, 4x230V		17 Modules	1/1	pcs

DISTRIBUTION BOXES ULISSE 17M

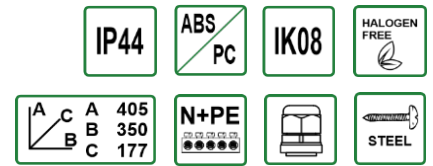

74182.226 ULISSE 17M - sockets 2x16A 5p, 4x32A 5p
74182.5 ULISSE 17M - sockets 3x16A 5p, 3x32A 5p

Modules	Box	Unit
17 Modules	1/1	pcs
17 Modules	1/1	pcs

74182.116 ULISSE 17M - sockets 6x16A 5p
74182.117 ULISSE 17M - sockets 6x32A 5p

Modules	Box	Unit
17 Modules	1/1	pcs
17 Modules	1/1	pcs

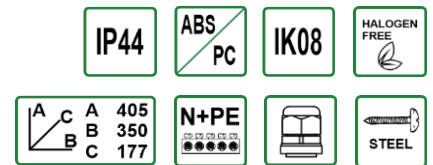

74182.43 ULISSE 17M - sockets 16A 5p, 32A 5p, 63A 5p, 3x230V
74182.195 ULISSE 17M - sockets 2x16A 5p, 63A 5p, 3x230V
74182.197 ULISSE 17M - sockets 2x32A 5p, 63A 5p, 3x230V

Modules	Box	Unit
17 Modules	1/1	pcs
17 Modules	1/1	pcs
17 Modules	1/1	pcs

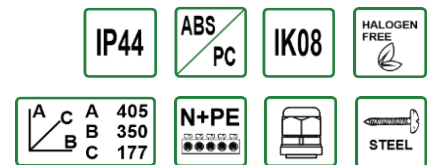

74182.69 ULISSE 17M - sockets 16A 5p, 32A 5p, 63A 5p, 4x230V
74182.196 ULISSE 17M - sockets 2x16A 5p, 63A 5p, 4x230V
74182.198 ULISSE 17M - sockets 2x32A 5p, 63A 5p, 4x230V

Modules	Box	Unit
17 Modules	1/1	pcs
17 Modules	1/1	pcs
17 Modules	1/1	pcs

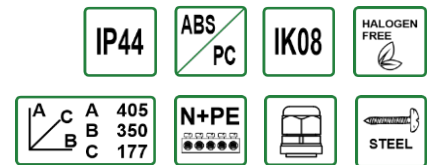

74182.45 ULISSE 17M - sockets 16A 5p, 32A 5p, 4x230V
74182.84 ULISSE 17M - sockets 2x16A 5p, 4x230V
74182.158 ULISSE 17M - sockets 2x32A 5p, 4x230V

Switch	Modules	Box	Unit
0-1 (32A)	17 Modules	1/1	pcs
0-1 (32A)	17 Modules	1/1	pcs
0-1 (32A)	17 Modules	1/1	pcs

74182.46 ULISSE 17M - sockets 16A 5p, 32A 5p, 4x230V
74182.199 ULISSE 17M - sockets 2x16A 5p, 4x230V
74182.200 ULISSE 17M - sockets 2x32A 5p, 4x230V

Switch	Modules	Box	Unit
L/P (32A)	17 Modules	1/1	pcs
L/P (32A)	17 Modules	1/1	pcs
L/P (32A)	17 Modules	1/1	pcs

DISTRIBUTION BOXES FEMO 13M



IP44 ABS/PC IK08 INOX

A	C	A	360
B	B	B	275
C	C	C	135

N+PE

Code	Description	IP65	Modules	Box	Unit
74183	Distributon box FEMO 13M		13 Modules	1/1	pcs
74183.27	FEMO 13M - sockets 16A 5p, 32A 5p, 2x230V		13 Modules	1/1	pcs
74183.79	FEMO 13M - sockets 2x16A 5p, 2x230V		13 Modules	1/1	pcs
74183.46	FEMO 13M - sockets 2x32A 5p, 2x230V		13 Modules	1/1	pcs



IP44 ABS/PC IK08 INOX

A	C	A	360
B	B	B	275
C	C	C	135

N+PE

Code	Description	Modules	Box	Unit
74183.0	FEMO 13M - sockets 16A 5p, 32A 5p, 3x230V	13 Modules	1/1	pcs
74183.1	FEMO 13M - sockets 2x16A 5p, 3x230V	13 Modules	1/1	pcs
74183.2	FEMO 13M - sockets 2x32A 5p, 3x230V	13 Modules	1/1	pcs
74183.10	FEMO 13M - sockets 16A 5p, 32A 5p, 4x230V	13 Modules	1/1	pcs
74183.17	FEMO 13M - sockets 2x16A 5p, 4x230V	13 Modules	1/1	pcs
74183.20	FEMO 13M - sockets 2x32A 5p, 4x230V	13 Modules	1/1	pcs



IP44 ABS/PC IK08 INOX

A	C	A	360
B	B	B	275
C	C	C	135

N+PE

Code	Description	Modules	Box	Unit
74183.122	FEMO 13M - sockets 16A 5p, 2x32A 5p, 2x230V	13 Modules	1/1	pcs
74183.89	FEMO 13M - sockets 2x16A 5p, 32A 5p, 2x230V	13 Modules	1/1	pcs
74183.99	FEMO 13M - sockets 3x16A 5p, 2x230V	13 Modules	1/1	pcs
74183.144	FEMO 13M - sockets 3x32A 5p, 2x230V	13 Modules	1/1	pcs



IP44 ABS/PC IK08 INOX

A	C	A	360
B	B	B	275
C	C	C	135

N+PE

Code	Description	Modules	Box	Unit
74183.86	FEMO 13M - sockets 16A 5p, 2x32A 5p, 3x230V	13 Modules	1/1	pcs
74183.126	FEMO 13M - sockets 2x16A 5p, 32A 5p, 3x230V	13 Modules	1/1	pcs
74183.83	FEMO 13M - sockets 3x16A 5p, 3x230V	13 Modules	1/1	pcs
74183.49	FEMO 13M - sockets 3x32A 5p, 3x230V	13 Modules	1/1	pcs
74183.149	FEMO 13M - sockets 16A 5p, 2x32A 5p, 4x230V	13 Modules	1/1	pcs
74183.19	FEMO 13M - sockets 2x16A 5p, 32A 5p, 4x230V	13 Modules	1/1	pcs
74183.150	FEMO 13M - sockets 3x16A 5p, 4x230V	13 Modules	1/1	pcs
74183.97	FEMO 13M - sockets 3x32A 5p, 4x230V	13 Modules	1/1	pcs

DISTRIBUTION BOXES FEMO 13M

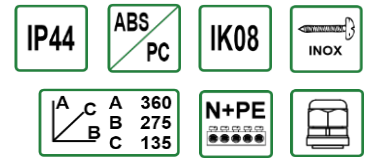

Code	Description	Switch	Modules	Box	Unit
74183.3	FEMO 13M - sockets 8x230V		13 Modules	1/1	pcs
74183.37	FEMO 13M - sockets 9x230V		13 Modules	1/1	pcs
74183.15	FEMO 13M - sockets 12x230V		13 Modules	1/1	pcs

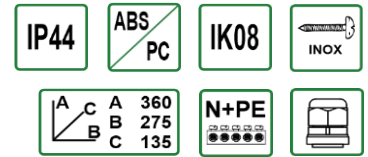
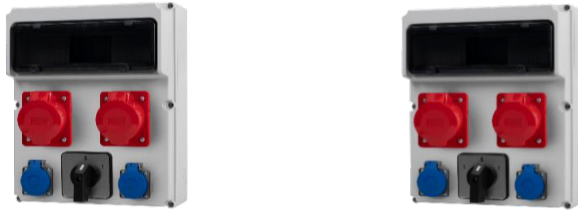

Code	Description	Switch	Modules	Box	Unit
74183.4	FEMO 13M - sockets 16A 5p, 32A 5p, 2x230V	0-1 (32A)	13 Modules	1/1	pcs
74183.5	FEMO 13M - sockets 2x16A 5p, 2x230V	0-1 (32A)	13 Modules	1/1	pcs
74183.6	FEMO 13M - sockets 2x32A 5p, 2x230V	0-1 (32A)	13 Modules	1/1	pcs

74183.7	FEMO 13M - sockets 16A 5p, 32A 5p, 2x230V	L/P (32A)	13 Modules	1/1	pcs
74183.8	FEMO 13M - sockets 2x16A 5p, 2x230V	L/P (32A)	13 Modules	1/1	pcs
74183.9	FEMO 13M - sockets 2x32A 5p, 2x230V	L/P (32A)	13 Modules	1/1	pcs

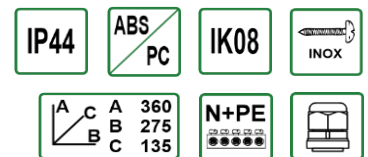

Code	Description	Switch	Modules	Box	Unit
74183.107	FEMO 13M - sockets 16A 5p, 32A 5p, 3x230V	0-1 (32A)	13 Modules	1/1	pcs
74183.145	FEMO 13M - sockets 2x16A 5p, 3x230V	0-1 (32A)	13 Modules	1/1	pcs
74183.135	FEMO 13M - sockets 2x32A 5p, 3x230V	0-1 (32A)	13 Modules	1/1	pcs

74183.119	FEMO 13M - sockets 16A 5p, 32A 5p, 3x230V	L/P (32A)	13 Modules	1/1	pcs
74183.41	FEMO 13M - sockets 2x16A 5p, 3x230V	L/P (32A)	13 Modules	1/1	pcs
74183.146	FEMO 13M - sockets 2x32A 5p, 3x230V	L/P (32A)	13 Modules	1/1	pcs

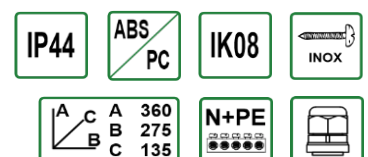

Code	Description	Switch	Modules	Box	Unit
74183.32	FEMO 13M - sockets 16A 5p, 32A 5p, 4x230V	0-1 (32A)	13 Modules	1/1	pcs
74183.147	FEMO 13M - sockets 2x16A 5p, 4x230V	0-1 (32A)	13 Modules	1/1	pcs
74183.137	FEMO 13M - sockets 2x32A 5p, 4x230V	0-1 (32A)	13 Modules	1/1	pcs

74183.26	FEMO 13M - sockets 16A 5p, 32A 5p, 4x230V	L/P (32A)	13 Modules	1/1	pcs
74183.148	FEMO 13M - sockets 2x16A 5p, 4x230V	L/P (32A)	13 Modules	1/1	pcs
74183.88	FEMO 13M - sockets 2x32A 5p, 4x230V	L/P (32A)	13 Modules	1/1	pcs

DISTRIBUTION BOXES FEMO 18M

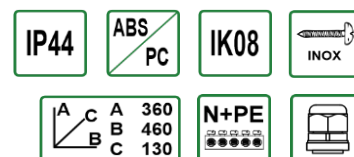

		IP65	Modules	Box	Unit
74191	Distributon box FEMO 18M		18 Modules	1/1	pcs
74191.3	FEMO 18M - sockets 16A 5p, 3x32A 5p, 4x230V		18 Modules	1/1	pcs
74191.4	FEMO 18M - sockets 2x16A 5p, 2x32A 5p, 4x230V		18 Modules	1/1	pcs
74191.5	FEMO 18M - sockets 3x16A 5p, 32A 5p, 4x230V		18 Modules	1/1	pcs
74191.1	FEMO 18M - sockets 4x16A 5p, 4x230V		18 Modules	1/1	pcs
74191.2	FEMO 18M - sockets 4x32A 5p, 4x230V		18 Modules	1/1	pcs

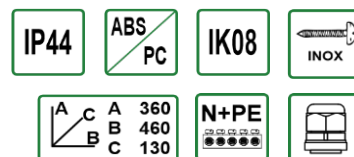

		IP65	Modules	Box	Unit
74191.8	FEMO 18M - sockets 16A 5p, 3x32A 5p, 6x230V		18 Modules	1/1	pcs
74191.9	FEMO 18M - sockets 2x16A 5p, 2x32A 5p, 6x230V		18 Modules	1/1	pcs
74191.10	FEMO 18M - sockets 3x16A 5p, 32A 5p, 6x230V		18 Modules	1/1	pcs
74191.6	FEMO 18M - sockets 4x16A 5p, 6x230V		18 Modules	1/1	pcs
74191.7	FEMO 18M - sockets 4x32A 5p, 6x230V		18 Modules	1/1	pcs

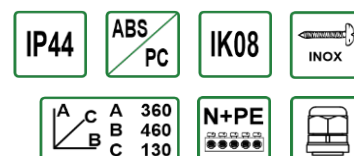

		IP65	Modules	Box	Unit
74191.29	FEMO 18M - sockets 2x16A 5p, 6x32A 5p		18 Modules	1/1	pcs
74191.30	FEMO 18M - sockets 3x16A 5p, 5x32A 5p		18 Modules	1/1	pcs
74191.31	FEMO 18M - sockets 4x16A 5p, 4x32A 5p		18 Modules	1/1	pcs
74191.32	FEMO 18M - sockets 5x16A 5p, 3x32A 5p		18 Modules	1/1	pcs
74191.33	FEMO 18M - sockets 6x16A 5p, 2x32A 5p		18 Modules	1/1	pcs
74191.34	FEMO 18M - sockets 8x16A 5p		18 Modules	1/1	pcs
74191.35	FEMO 18M - sockets 8x32A 5p		18 Modules	1/1	pcs

DISTRIBUTION BOXES LEGATO 16M

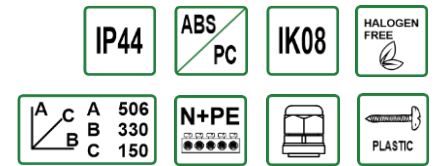

		IP65	Modules	Box	Unit
75100	Distributon box LEGATO 16M		16 Modules	1/1	pcs
75100.273	LEGATO 16M - sockets 16A 5p, 3x32A 5p, 3x230V		16 Modules	1/1	pcs
75100.0	LEGATO 16M - sockets 2x16A 5p, 2x32A 5p, 3x230V		16 Modules	1/1	pcs
75100.274	LEGATO 16M - sockets 3x16A 5p, 32A 5p, 3x230V		16 Modules	1/1	pcs
75100.259	LEGATO 16M - sockets 4x16A 5p, 3x230V		16 Modules	1/1	pcs
75100.250	LEGATO 16M - sockets 4x32A 5p, 3x230V		16 Modules	1/1	pcs

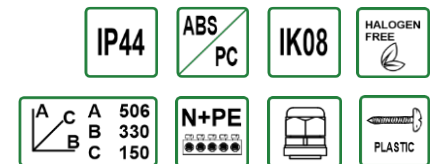

		IP65	Modules	Box	Unit
75100.131	LEGATO 16M - sockets 16A 5p, 3x32A 5p, 4x230V		16 Modules	1/1	pcs
75100.144	LEGATO 16M - sockets 2x16A 5p, 2x32A 5p, 4x230V		16 Modules	1/1	pcs
75100.275	LEGATO 16M - sockets 3x16A 5p, 32A 5p, 4x230V		16 Modules	1/1	pcs
75100.265	LEGATO 16M - sockets 4x16A 5p, 4x230V		16 Modules	1/1	pcs
75100.4	LEGATO 16M - sockets 4x32A 5p, 4x230V		16 Modules	1/1	pcs

75100.128	LEGATO 16M - sockets 16A 5p, 3x32A 5p, 6x230V		16 Modules	1/1	pcs
75100.1	LEGATO 16M - sockets 2x16A 5p, 2x32A 5p, 6x230V		16 Modules	1/1	pcs
75100.276	LEGATO 16M - sockets 3x16A 5p, 32A 5p, 6x230V		16 Modules	1/1	pcs
75100.256	LEGATO 16M - sockets 4x16A 5p, 6x230V		16 Modules	1/1	pcs
75100.5	LEGATO 16M - sockets 4x32A 5p, 6x230V		16 Modules	1/1	pcs

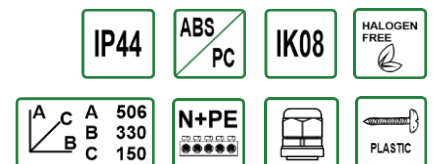

		IP65	Modules	Box	Unit
75100.2	LEGATO 16M - sockets 16A 5p, 2x32A 5p, 10x230V		16 Modules	1/1	pcs
75100.160	LEGATO 16M - sockets 2x16A 5p, 32A 5p, 10x230V		16 Modules	1/1	pcs
75100.277	LEGATO 16M - sockets 3x16A 5p, 10x230V		16 Modules	1/1	pcs
75100.245	LEGATO 16M - sockets 3x32A 5p, 10x230V		16 Modules	1/1	pcs

DISTRIBUTION BOXES LEGATO 16M

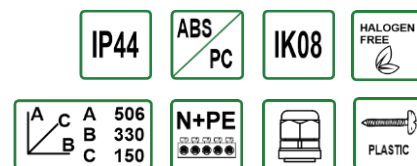

		Modules	Box	Unit
75100.278	LEGATO 16M - sockets 16A 5p, 5x32A 5p	16 Modules	1/1	pcs
75100.279	LEGATO 16M - sockets 2x16A 5p, 4x32A 5p	16 Modules	1/1	pcs
75100.3	LEGATO 16M - sockets 3x16A 5p, 3x32A 5p	16 Modules	1/1	pcs
75100.280	LEGATO 16M - sockets 4x16A 5p, 2x32A 5p	16 Modules	1/1	pcs
75100.281	LEGATO 16M - sockets 5x16A 5p, 32A 5p	16 Modules	1/1	pcs
75100.282	LEGATO 16M - sockets 6x16A 5p	16 Modules	1/1	pcs
75100.283	LEGATO 16M - sockets 6x32A 5p	16 Modules	1/1	pcs

DISTRIBUTION BOXES LEGATO 32M

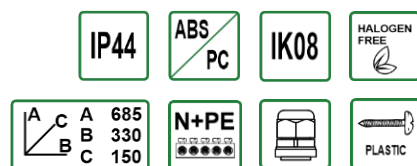

		Modules	Box	Unit
76100	Distributon box LEGATO 32M	IP65	32 Modules	1/1 pcs
76100.107	LEGATO 32M - sockets 16A 5p, 3x32A 5p, 3x230V	32 Modules	1/1	pcs
76100.0	LEGATO 32M - sockets 2x16A 5p, 2x32A 5p, 3x230V	32 Modules	1/1	pcs
76100.108	LEGATO 32M - sockets 3x16A 5p, 32A 5p, 3x230V	32 Modules	1/1	pcs
76100.109	LEGATO 32M - sockets 4x16A 5p, 3x230V	32 Modules	1/1	pcs
76100.70	LEGATO 32M - sockets 4x32A 5p, 3x230V	32 Modules	1/1	pcs

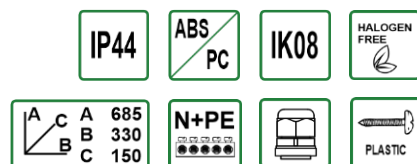

		Modules	Box	Unit
76100.110	LEGATO 32M - sockets 16A 5p, 3x32A 5p, 4x230V	32 Modules	1/1	pcs
76100.27	LEGATO 32M - sockets 2x16A 5p, 2x32A 5p, 4x230V	32 Modules	1/1	pcs
76100.111	LEGATO 32M - sockets 3x16A 5p, 32A 5p, 4x230V	32 Modules	1/1	pcs
76100.112	LEGATO 32M - sockets 4x16A 5p, 4x230V	32 Modules	1/1	pcs
76100.53	LEGATO 32M - sockets 4x32A 5p, 4x230V	32 Modules	1/1	pcs

DISTRIBUTION BOXES LEGATO 32M

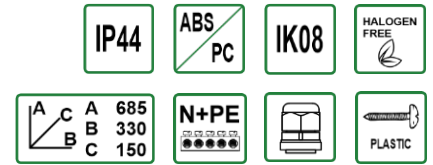

- 76100.113** LEGATO 32M - sockets 16A 5p, 3x32A 5p, 6x230V
- 76100.1** LEGATO 32M - sockets 2x16A 5p, 2x32A 5p, 6x230V
- 76100.114** LEGATO 32M - sockets 3x16A 5p, 32A 5p, 6x230V
- 76100.47** LEGATO 32M - sockets 4x16A 5p, 6x230V
- 76100.67** LEGATO 32M - sockets 4x32A 5p, 6x230V

Modules **Box** **Unit**

32 Modules	1/1	pcs
32 Modules	1/1	pcs
32 Modules	1/1	pcs
32 Modules	1/1	pcs
32 Modules	1/1	pcs

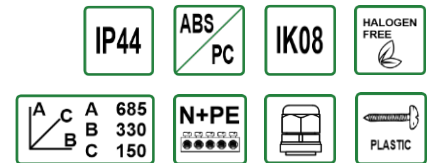

- 76100.2** LEGATO 32M - sockets 16A 5p, 2x32A 5p, 10x230V
- 76100.115** LEGATO 32M - sockets 2x16A 5p, 32A 5p, 10x230V
- 76100.116** LEGATO 32M - sockets 3x16A 5p, 10x230V
- 76100.117** LEGATO 32M - sockets 3x32A 5p, 10x230V

Modules **Box** **Unit**

32 Modules	1/1	pcs
32 Modules	1/1	pcs
32 Modules	1/1	pcs
32 Modules	1/1	pcs

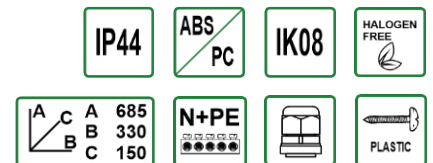

- 76100.118** LEGATO 32M - sockets 16A 5p, 5x32A 5p
- 76100.119** LEGATO 32M - sockets 2x16A 5p, 4x32A 5p
- 76100.3** LEGATO 32M - sockets 3x16A 5p, 3x32A 5p
- 76100.120** LEGATO 32M - sockets 4x16A 5p, 2x32A 5p
- 76100.121** LEGATO 32M - sockets 5x16A 5p, 32A 5p
- 76100.122** LEGATO 32M - sockets 6x16A 5p
- 76100.123** LEGATO 32M - sockets 6x32A 5p

Modules **Box** **Unit**

32 Modules	1/1	pcs
32 Modules	1/1	pcs
32 Modules	1/1	pcs
32 Modules	1/1	pcs
32 Modules	1/1	pcs
32 Modules	1/1	pcs
32 Modules	1/1	pcs

DISTRIBUTION BOXES LAGO 5M

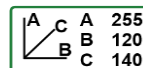

Code	Description	IP	Modules	Box	Unit
F3.1858	Distributon box LAGO 5M	IP66	5 Modules	1/1	pcs
F3.1921	LAGO 5M - sockets 16A 5p		5 Modules	1/1	pcs
F3.1922	LAGO 5M - sockets 32A 5p		5 Modules	1/1	pcs

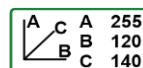

Code	Description	IP	Modules	Box	Unit
F3.1859	LAGO 5M - sockets 2x230V		5 Modules	1/1	pcs
F3.1860	LAGO 5M - sockets 4x230V		5 Modules	1/1	pcs

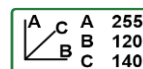

Code	Description	IP	Modules	Box	Unit
F3.1923	LAGO 5M - sockets 16A 5p, 230V		5 Modules	1/1	pcs
F3.1924	LAGO 5M - sockets 32A 5p, 230V		5 Modules	1/1	pcs
F3.1925	LAGO 5M - sockets 16A 5p, 2x230V		5 Modules	1/1	pcs
F3.1926	LAGO 5M - sockets 32A 5p, 2x230V		5 Modules	1/1	pcs

DISTRIBUTION BOXES LAGO 6M

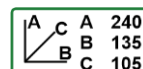

Code	Description	IP	Modules	Box	Unit
F3.0270	Distributon box LAGO 6M	IP54	6 Modules	1/1	pcs
F3.0273	LAGO 6M - sockets 16A 5p		6 Modules	1/1	pcs
F3.0274	LAGO 6M - sockets 32A 5p		6 Modules	1/1	pcs

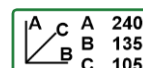

Code	Description	IP	Modules	Box	Unit
F3.0271	LAGO 6M - sockets 2x230V		6 Modules	1/1	pcs
F3.0272	LAGO 6M - sockets 4x230V		6 Modules	1/1	pcs

DISTRIBUTION BOXES LAGO 6M

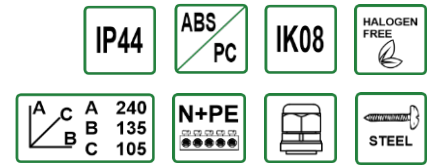

			Modules	Box	Unit
F3.0275	LAGO 6M - sockets 16A 5p, 230V		6 Modules	1/1	pcs
F3.0277	LAGO 6M - sockets 32A 5p, 230V		6 Modules	1/1	pcs
F3.0276	LAGO 6M - sockets 16A 5p, 2x230V		6 Modules	1/1	pcs
F3.0278	LAGO 6M - sockets 32A 5p, 2x230V		6 Modules	1/1	pcs

DISTRIBUTION BOXES LAGO 7M

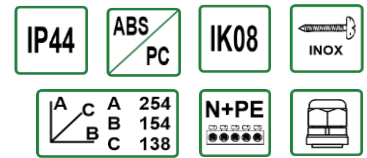

			Modules	Box	Unit
F3.0843	Distributon box LAGO 7M	IP66	7 Modules	1/1	pcs
F3.0846	LAGO 7M - sockets 16A 5p		7 Modules	1/1	pcs
F3.0847	LAGO 7M - sockets 32A 5p		7 Modules	1/1	pcs

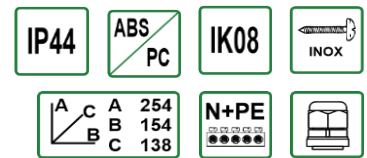

			Modules	Box	Unit
F3.0844	LAGO 7M - sockets 2x230V		7 Modules	1/1	pcs
F3.0845	LAGO 7M - sockets 4x230V		7 Modules	1/1	pcs

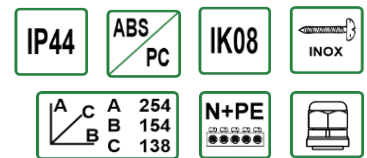

			Modules	Box	Unit
F3.0848	LAGO 7M - sockets 16A 5p, 230V		7 Modules	1/1	pcs
F3.0850	LAGO 7M - sockets 32A 5p, 230V		7 Modules	1/1	pcs
F3.0849	LAGO 7M - sockets 16A 5p, 2x230V		7 Modules	1/1	pcs
F3.0851	LAGO 7M - sockets 32A 5p, 2x230V		7 Modules	1/1	pcs

DISTRIBUTION BOXES LAGO 10M

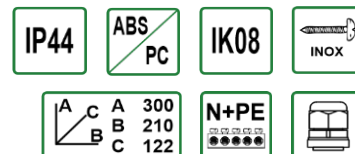

Code	Description	IP66	Modules	Box	Unit
F3.0852	Distributon box LAGO 10M		10 Modules	1/1	pcs
F3.0855	LAGO 10M - sockets 16A 5p, 32A 5p		10 Modules	1/1	pcs
F3.0853	LAGO 10M - sockets 2x16A 5p		10 Modules	1/1	pcs
F3.0854	LAGO 10M - sockets 2x32A 5p		10 Modules	1/1	pcs

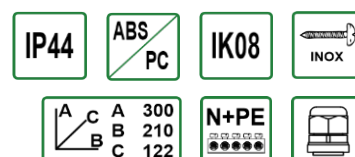

Code	Description	Modules	Box	Unit
F3.0859	LAGO 10M - sockets 16A 5p, 2x230V	10 Modules	1/1	pcs
F3.0860	LAGO 10M - sockets 32A 5p, 2x230V	10 Modules	1/1	pcs
F3.0856	LAGO 10M - sockets 2x16A 5p, 2x230V	10 Modules	1/1	pcs
F3.0857	LAGO 10M - sockets 2x32A 5p, 2x230V	10 Modules	1/1	pcs
F3.0858	LAGO 10M - sockets 16A 5p, 32A 5p, 2x230V	10 Modules	1/1	pcs

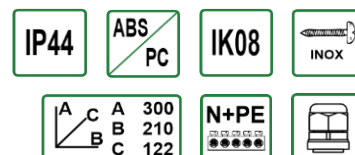

Code	Description	Modules	Box	Unit
F3.0861	LAGO 10M - sockets 16A 5p, 3x230V	10 Modules	1/1	pcs
F3.0862	LAGO 10M - sockets 32A 5p, 3x230V	10 Modules	1/1	pcs
F3.0863	LAGO 10M - sockets 16A 5p, 4x230V	10 Modules	1/1	pcs
F3.0864	LAGO 10M - sockets 32A 5p, 4x230V	10 Modules	1/1	pcs

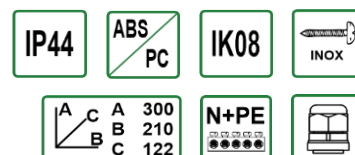

Code	Description	Modules	Box	Unit
F3.0865	LAGO 10M - sockets 6x230V	10 Modules	1/1	pcs

DISTRIBUTION BOXES 10M BICOLOR



IP44 ABS/PC IK08 INOX

A C A 300
B B 210
C C 122

N+PE

		Modules	Box	Unit
F3.2670	LAGO 10M BICOLOR - sockets 16A 5p, 32A 5p	10 Modules	1/1	pcs
F3.2671	LAGO 10M BICOLOR - sockets 2x16A 5p	10 Modules	1/1	pcs
F3.2672	LAGO 10M BICOLOR - sockets 2x32A 5p	10 Modules	1/1	pcs



IP44 ABS/PC IK08 INOX

A C A 300
B B 210
C C 122

N+PE

		Modules	Box	Unit
F3.2673	LAGO 10M BICOLOR - sockets 16A 5p, 2x230V	10 Modules	1/1	pcs
F3.2674	LAGO 10M BICOLOR - sockets 32A 5p, 2x230V	10 Modules	1/1	pcs



IP44 ABS/PC IK08 INOX

A C A 300
B B 210
C C 122

N+PE

		Modules	Box	Unit
F3.2675	LAGO 10M BICOLOR - sockets 16A 5p, 3x230V	10 Modules	1/1	pcs
F3.2676	LAGO 10M BICOLOR - sockets 32A 5p, 3x230V	10 Modules	1/1	pcs
F3.2677	LAGO 10M BICOLOR - sockets 16A 5p, 4x230V	10 Modules	1/1	pcs
F3.2678	LAGO 10M BICOLOR - sockets 32A 5p, 4x230V	10 Modules	1/1	pcs



IP44 ABS/PC IK08 INOX

A C A 300
B B 210
C C 122

N+PE

		Modules	Box	Unit
F3.2679	LAGO 10M BICOLOR - sockets 6x230V	10 Modules	1/1	pcs

DISTRIBUTION BOXES LAGO 11M

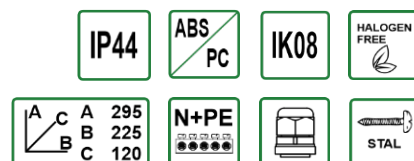

		IP54	Modules	Box	Unit
F3.0279	Distributon box LAGO 11M		11 modules	1/1	pcs
F3.0282	LAGO 11M - sockets 16A 5p, 32A 5p		11 modules	1/1	pcs
F3.0280	LAGO 11M - sockets 2x16A 5p		11 modules	1/1	pcs
F3.0281	LAGO 11M - sockets 2x32A 5p		11 modules	1/1	pcs

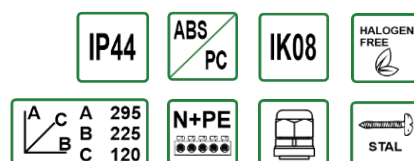

		IP54	Modules	Box	Unit
F3.0286	LAGO 11M - sockets 16A 5p, 2x230V		11 modules	1/1	pcs
F3.0287	LAGO 11M - sockets 32A 5p, 2x230V		11 modules	1/1	pcs

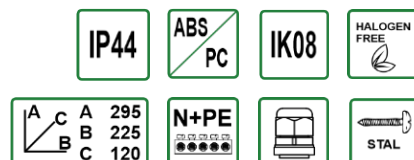

		IP54	Modules	Box	Unit
F3.0285	LAGO 11M - sockets 16A 5p, 32A 5p, 2x230V		11 modules	1/1	pcs
F3.0283	LAGO 11M - sockets 2x16A 5p, 2x230V		11 modules	1/1	pcs
F3.0284	LAGO 11M - sockets 2x32A 5p, 2x230V		11 modules	1/1	pcs

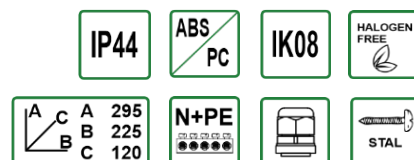

		IP54	Modules	Box	Unit
F3.0480	LAGO 11M - sockets 16A 5p, 3x230V		11 modules	1/1	pcs
F3.0481	LAGO 11M - sockets 32A 5p, 3x230V		11 modules	1/1	pcs
F3.0482	LAGO 11M - sockets 16A 5p, 4x230V		11 modules	1/1	pcs
F3.0483	LAGO 11M - sockets 32A 5p, 4x230V		11 modules	1/1	pcs

DISTRIBUTION BOXES LAGO 11M



Panel Mounted Socket

		Modules	Box	Unit
F3.2621	LAGO 11M - sockets 16A 5p, 32A 5p, 3x230V	11 modules	1/1	pcs
F3.2622	LAGO 11M - sockets 2x16A 5p, 3x230V	11 modules	1/1	pcs
F3.2623	LAGO 11M - sockets 2x32A 5p, 3x230V	11 modules	1/1	pcs



Panel Mounted Socket

		Switch	Modules	Box	Unit
F3.2605	LAGO 11M - sockets 16A 5p, 32A 5p, 2x230V	0-1 (32A)	11 modules	1/1	pcs
F3.2606	LAGO 11M - sockets 2x16A 5p, 2x230V	0-1 (32A)	11 modules	1/1	pcs
F3.2607	LAGO 11M - sockets 2x32A 5p, 2x230V	0-1 (32A)	11 modules	1/1	pcs



Panel Mounted Socket

		Funkcja	Modules	Box	Unit
F3.0442	LAGO 11M - sockets 16A 5p, 32A 5p, 2x230V	L/P (32A)	11 modules	1/1	pcs
F3.1133	LAGO 11M - sockets 2x16A 5p, 2x230V	L/P (32A)	11 modules	1/1	pcs
F3.2604	LAGO 11M - sockets 2x32A 5p, 2x230V	L/P (32A)	11 modules	1/1	pcs



		Modules	Box	Unit
F3.0359	LAGO 11M - sockets 6x230V	11 modules	1/1	pcs
F3.0954	LAGO 11M - sockets 7x230V	11 modules	1/1	pcs
F3.0955	LAGO 11M - sockets 8x230V	11 modules	1/1	pcs

DISTRIBUTION BOXES LAGO 14M

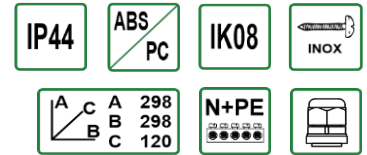

Code	Description	IP	Modules	Box	Unit
F3.1826	Distributon box LAGO 14M	IP66	14 Modules	1/1	pcs
F3.1016	LAGO 14M - sockets 16A 5p, 2x32A 5p		14 Modules	1/1	pcs
F3.1017	LAGO 14M - sockets 2x16A 5p, 32A 5p		14 Modules	1/1	pcs
F3.1014	LAGO 14M - sockets 3x16A 5p		14 Modules	1/1	pcs
F3.1015	LAGO 14M - sockets 3x32A 5p		14 Modules	1/1	pcs

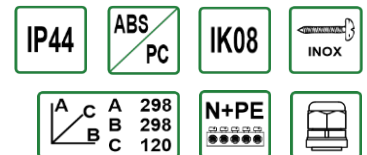

Code	Description	Modules	Box	Unit
F3.1020	LAGO 14M - sockets 16A 5p, 32A 5p, 2x230V	14 Modules	1/1	pcs
F3.1018	LAGO 14M - sockets 2x16A 5p, 2x230V	14 Modules	1/1	pcs
F3.1019	LAGO 14M - sockets 2x32A 5p, 2x230V	14 Modules	1/1	pcs

F3.1023	LAGO 14M - sockets 16A 5p, 32A 5p, 3x230V	14 Modules	1/1	pcs
F3.1021	LAGO 14M - sockets 2x16A 5p, 3x230V	14 Modules	1/1	pcs
F3.1022	LAGO 14M - sockets 2x32A 5p, 3x230V	14 Modules	1/1	pcs

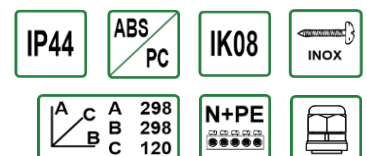

Code	Description	Modules	Box	Unit
F3.1026	LAGO 14M - sockets 16A 5p, 32A 5p, 4x230V	14 Modules	1/1	pcs
F3.1024	LAGO 14M - sockets 2x16A 5p, 4x230V	14 Modules	1/1	pcs
F3.1025	LAGO 14M - sockets 2x32A 5p, 4x230V	14 Modules	1/1	pcs

F3.1027	LAGO 14M - sockets 16A 5p, 6x230V	14 Modules	1/1	pcs
F3.1028	LAGO 14M - sockets 32A 5p, 6x230V	14 Modules	1/1	pcs

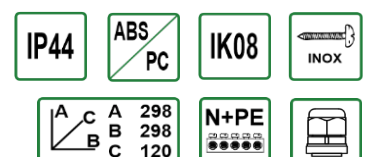

F3.1029	LAGO 14M - sockets 8x230V	14 Modules	1/1	pcs
---------	---------------------------	------------	-----	-----

DISTRIBUTION BOXES LAGO 17M

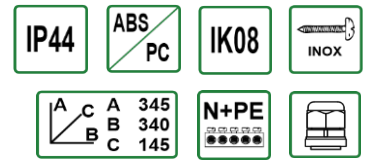

Code	Description	IP65	Modules	Box	Unit
F3.0571	Distributon box LAGO 17M		17 Modules	1/1	pcs
F3.1783	LAGO 17M - sockets 8x230V		17 Modules	1/1	pcs
F3.0515	LAGO 17M - sockets 10x230V		17 Modules	1/1	pcs

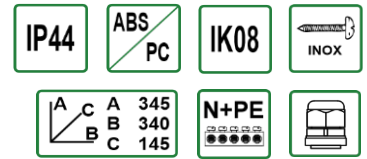

Code	Description	Modules	Box	Unit
F3.0511	LAGO 17M - sockets 16A 5p, 4x230V	17 Modules	1/1	pcs
F3.0512	LAGO 17M - sockets 32A 5p, 4x230V	17 Modules	1/1	pcs
F3.0513	LAGO 17M - sockets 16A 5p, 8x230V	17 Modules	1/1	pcs
F3.0514	LAGO 17M - sockets 32A 5p, 8x230V	17 Modules	1/1	pcs

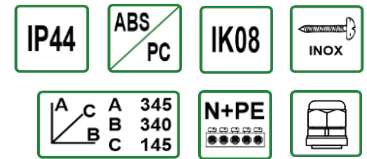

Code	Description	Modules	Box	Unit
F3.0500	LAGO 17M - sockets 16A 5p, 32A 5p, 2x230V	17 Modules	1/1	pcs
F3.0498	LAGO 17M - sockets 2x16A 5p, 2x230V	17 Modules	1/1	pcs
F3.0499	LAGO 17M - sockets 2x32A 5p, 2x230V	17 Modules	1/1	pcs
F3.0503	LAGO 17M - sockets 16A 5p, 32A 5p, 3x230V	17 Modules	1/1	pcs
F3.0501	LAGO 17M - sockets 2x16A 5p, 3x230V	17 Modules	1/1	pcs
F3.0502	LAGO 17M - sockets 2x32A 5p, 3x230V	17 Modules	1/1	pcs

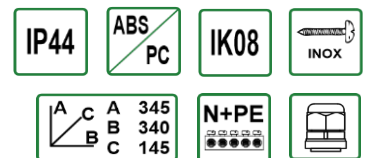
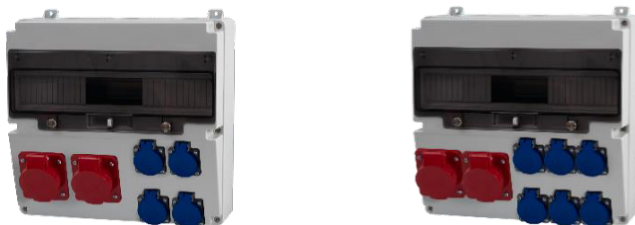

Code	Description	Modules	Box	Unit
F3.0506	LAGO 17M - sockets 16A 5p, 32A 5p, 4x230V	17 Modules	1/1	pcs
F3.0504	LAGO 17M - sockets 2x16A 5p, 4x230V	17 Modules	1/1	pcs
F3.0505	LAGO 17M - sockets 2x32A 5p, 4x230V	17 Modules	1/1	pcs
F3.1728	LAGO 17M - sockets 16A 5p, 32A 5p, 6x230V	17 Modules	1/1	pcs
F3.1781	LAGO 17M - sockets 2x16A 5p, 6x230V	17 Modules	1/1	pcs
F3.1782	LAGO 17M - sockets 2x32A 5p, 6x230V	17 Modules	1/1	pcs

DISTRIBUTION BOXES LAGO 17M



IP44 ABS/PC IK08 INOX

A C 345
B B 340
C C 145

N+PE

Code	Description	Modules	Box	Unit
F3.0496	LAGO 17M - sockets 16A 5p, 2x32A 5p	17 Modules	1/1	pcs
F3.0497	LAGO 17M - sockets 2x16A 5p, 32A 5p	17 Modules	1/1	pcs
F3.0494	LAGO 17M - sockets 3x16A 5p	17 Modules	1/1	pcs
F3.0495	LAGO 17M - sockets 3x32A 5p	17 Modules	1/1	pcs
F3.0509	LAGO 17M - sockets 16A 5p, 2x32A 5p, 2x230V	17 Modules	1/1	pcs
F3.0510	LAGO 17M - sockets 2x16A 5p, 32A 5p, 2x230V	17 Modules	1/1	pcs
F3.0507	LAGO 17M - sockets 3x16A 5p, 2x230V	17 Modules	1/1	pcs
F3.0508	LAGO 17M - sockets 3x32A 5p, 2x230V	17 Modules	1/1	pcs



IP44 ABS/PC IK08 INOX

A C 345
B B 340
C C 145

N+PE

Code	Description	Modules	Box	Unit
F3.0491	LAGO 17M - sockets 16A 5p, 3x32A 5p	17 Modules	1/1	pcs
F3.0492	LAGO 17M - sockets 2x16A 5p, 2x32A 5p	17 Modules	1/1	pcs
F3.0493	LAGO 17M - sockets 3x16A 5p, 32A 5p	17 Modules	1/1	pcs
F3.0489	LAGO 17M - sockets 4x16A 5p	17 Modules	1/1	pcs
F3.0490	LAGO 17M - sockets 4x32A 5p	17 Modules	1/1	pcs



IP44 ABS/PC IK08 INOX

A C 345
B B 340
C C 145

N+PE

Panel Mounted Socket

Code	Description	Modules	Box	Unit
F3.0761	LAGO 17M - sockets 16A 5p, 3x32A 5p, 4x230V	17 Modules	1/1	pcs
F3.0762	LAGO 17M - sockets 2x16A 5p, 2x32A 5p, 4x230V	17 Modules	1/1	pcs
F3.0763	LAGO 17M - sockets 3x16A 5p, 32A 5p, 4x230V	17 Modules	1/1	pcs
F3.0759	LAGO 17M - sockets 4x16A 5p, 4x230V	17 Modules	1/1	pcs
F3.0760	LAGO 17M - sockets 4x32A 5p, 4x230V	17 Modules	1/1	pcs

Code	Description	Plug	Modules	Box	Unit
F3.0766	LAGO 17M - sockets 16A 5p, 2x32A 5p, 4x230V	32A 5p	17 Modules	1/1	pcs
F3.0767	LAGO 17M - sockets 2x16A 5p, 32A 5p, 4x230V	32A 5p	17 Modules	1/1	pcs
F3.0764	LAGO 17M - sockets 3x16A 5p, 4x230V	32A 5p	17 Modules	1/1	pcs
F3.0765	LAGO 17M - sockets 3x32A 5p, 4x230V	32A 5p	17 Modules	1/1	pcs

DISTRIBUTION BOXES FORTE 11M

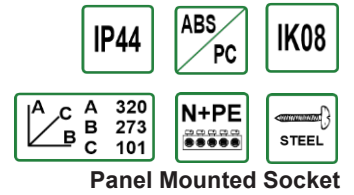

		Modules	Box	Unit
F3.1060	FORTE 11M - sockets 16A 5p, 2x32A 5p, 4x230V	11 Modules	1/1	pcs
F3.1061	FORTE 11M - sockets 2x16A 5p, 32A 5p, 4x230V	11 Modules	1/1	pcs
F3.1058	FORTE 11M - sockets 3x16A 5p, 4x230V	11 Modules	1/1	pcs
F3.1059	FORTE 11M - sockets 3x32A 5p, 4x230V	11 Modules	1/1	pcs

		Plug	Modules	Box	Unit
F3.1064	FORTE 11M - sockets 16A 5p, 32A 5p, 4x230V	16A 5p	11 Modules	1/1	pcs
F3.1065	FORTE 11M - sockets 16A 5p, 32A 5p, 4x230V	32A 5p	11 Modules	1/1	pcs
F3.1062	FORTE 11M - sockets 2x16A 5p, 4x230V	16A 5p	11 Modules	1/1	pcs
F3.1063	FORTE 11M - sockets 2x32A 5p, 4x230V	32A 5p	11 Modules	1/1	pcs

RUBBER DISTRIBUTION BOXES LIDO



		Modules	Box	Unit
F3.0348	LIDO - sockets 12M 16A 5p, 32A 5p, 2x230V	12 Modules	1/1	pcs
F3.0349	LIDO - sockets 12M 2x16A 5p, 2x230V	12 Modules	1/1	pcs
F3.0350	LIDO - sockets 12M 2x32A 5p, 2x230V	12 Modules	1/1	pcs

F3.0354	LIDO - sockets 18M 16A 5p, 2x32A 5p, 4x230V	18 Modules	1/1	pcs
F3.0353	LIDO - sockets 18M 2x16A 5p, 32A 5p, 4x230V	18 Modules	1/1	pcs
F3.0351	LIDO - sockets 18M 3x16A 5p, 4x230V	18 Modules	1/1	pcs
F3.0352	LIDO - sockets 18M 3x32A 5p, 4x230V	18 Modules	1/1	pcs

DISTRIBUTION BOXES ACQUA

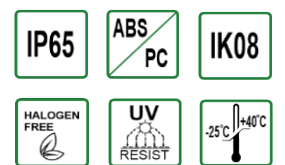

		Dimensions [mm]	U [V]	Box	Unit
F3.0141	ACQUA ECO 1/4 modules transparent smoked	171x100x100	690V	1/1	pcs
F3.0125	ACQUA 1/4 modules transparent smoked	215x145x110	1000V	1/1	pcs
F3.0126	ACQUA 1/8 modules transparent smoked	215x235x110	1000V	1/1	pcs
F3.0127	ACQUA 1/12 modules transparent smoked	215x310x110	1000V	1/1	pcs
F3.0128	ACQUA 2/26 modules transparent smoked	410x310x150	1000V	1/1	pcs
F3.0129	ACQUA 3/42 modules transparent smoked	565x310x150	1000V	1/1	pcs

INDUSTRIAL DISTRIBUTION BOXES RB



- F3.0528 RB-200 - sockets 2x230V
- F3.0529 RB-200 - sockets 4x230V

IP65	ABS						
<table border="1"> <tr><td>A</td><td>300</td></tr> <tr><td>B</td><td>200</td></tr> <tr><td>C</td><td>130</td></tr> </table>	A	300	B	200	C	130	RAL 7035
A	300						
B	200						
C	130						
IK08	<table border="1"> <tr><td>-35°C</td><td>+65°C</td></tr> </table>	-35°C	+65°C				
-35°C	+65°C						

Box	Unit
1/1	pcs
1/1	pcs



- F3.0144 RB-200 - sockets 16A 5p, 230V
- F3.0145 RB-200 - sockets 32A 5p, 230V
- F3.0530 RB-200 - sockets 16A 5p, 2x230V
- F3.0531 RB-200 - sockets 32A 5p, 2x230V

IP65	ABS						
<table border="1"> <tr><td>A</td><td>300</td></tr> <tr><td>B</td><td>200</td></tr> <tr><td>C</td><td>130</td></tr> </table>	A	300	B	200	C	130	RAL 7035
A	300						
B	200						
C	130						
IK08	<table border="1"> <tr><td>-35°C</td><td>+65°C</td></tr> </table>	-35°C	+65°C				
-35°C	+65°C						

Box	Unit
1/1	pcs
1/1	pcs
1/1	pcs
1/1	pcs



- F3.0137 RB-250 - sockets 16A 5p, 32A 5p, 2x230V
- F3.0148 RB-250 - sockets 2x16A 5p, 2x230V
- F3.0149 RB-250 - sockets 2x32A 5p, 2x230V
- F3.0572 RB-250 - sockets 16A 5p, 32A 5p, 4x230V
- F3.0573 RB-250 - sockets 2x16A 5p, 4x230V
- F3.0574 RB-250 - sockets 2x32A 5p, 4x230V

IP65	ABS						
<table border="1"> <tr><td>A</td><td>350</td></tr> <tr><td>B</td><td>250</td></tr> <tr><td>C</td><td>150</td></tr> </table>	A	350	B	250	C	150	RAL 7035
A	350						
B	250						
C	150						
IK08	<table border="1"> <tr><td>-35°C</td><td>+65°C</td></tr> </table>	-35°C	+65°C				
-35°C	+65°C						

Box	Unit
1/1	pcs
1/1	pcs
1/1	pcs
1/1	pcs
1/1	pcs
1/1	pcs



- F3.0536 RB-250 - sockets 16A 5p, 32A 5p, 2x230V
- F3.0532 RB-250 - sockets 2x16A 5p, 2x230V
- F3.0534 RB-250 - sockets 2x32A 5p, 2x230V

Switch

- F3.0537 RB-250 - sockets 16A 5p, 32A 5p, 2x230V
- F3.0533 RB-250 - sockets 2x16A 5p, 2x230V
- F3.0535 RB-250 - sockets 2x32A 5p, 2x230V

IP65	ABS						
<table border="1"> <tr><td>A</td><td>350</td></tr> <tr><td>B</td><td>250</td></tr> <tr><td>C</td><td>150</td></tr> </table>	A	350	B	250	C	150	RAL 7035
A	350						
B	250						
C	150						
IK08	<table border="1"> <tr><td>-35°C</td><td>+65°C</td></tr> </table>	-35°C	+65°C				
-35°C	+65°C						

Box	Unit
1/1	pcs
1/1	pcs
1/1	pcs
1/1	pcs
1/1	pcs
1/1	pcs

INDUSTRIAL DISTRIBUTION BOXES RB WITH MODULES



IP65 **ABS**

RAL 7035

IK08 **-35°C** **+55°C**

A 350
B 250
C 150

		Modules	Box	Unit
F3.0136	RB-250 - sockets 16A 5p, 230V	8 Modules	1/1	pcs
F3.0135	RB-250 - sockets 32A 5p, 230V	8 Modules	1/1	pcs
F3.0538	RB-250 - sockets 16A 5p, 2x230V	8 Modules	1/1	pcs
F3.0539	RB-250 - sockets 32A 5p, 2x230V	8 Modules	1/1	pcs
F3.0540	RB-250 - sockets 2x16A 5p	8 Modules	1/1	pcs
F3.0541	RB-250 - sockets 2x32A 5p	8 Modules	1/1	pcs
F3.0440	RB-250 - sockets 16A 5p, 32A 5p	8 Modules	1/1	pcs
F3.0542	RB-250 - sockets 6x230V	8 Modules	1/1	pcs



IP65 **ABS**

RAL 7035

IK08 **-35°C** **+55°C**

A 400
B 300
C 170

		Modules	Box	Unit
F3.0138	RB-300 - sockets 16A 5p, 32A 5p, 2x230V	12 Modules	1/1	pcs
F3.0150	RB-300 - sockets 2x16A 5p, 2x230V	12 Modules	1/1	pcs
F3.0151	RB-300 - sockets 2x32A 5p, 2x230V	12 Modules	1/1	pcs
F3.0139	RB-300 - sockets 16A 5p, 32A 5p, 3x230V	12 Modules	1/1	pcs
F3.0152	RB-300 - sockets 2x16A 5p, 3x230V	12 Modules	1/1	pcs
F3.0153	RB-300 - sockets 2x32A 5p, 3x230V	12 Modules	1/1	pcs



IP65 **ABS**

RAL 7035

IK08 **-35°C** **+55°C**

A 400
B 300
C 170

		Switch	Modules	Box	Unit
F3.0547	RB-300 - sockets 16A 5p, 32A 5p, 2x230V	0-1 (32A)	12 Modules	1/1	pcs
F3.0543	RB-300 - sockets 2x16A 5p, 2x230V	0-1 (32A)	12 Modules	1/1	pcs
F3.0545	RB-300 - sockets 2x32A 5p, 2x230V	0-1 (32A)	12 Modules	1/1	pcs
F3.0548	RB-300 - sockets 16A 5p, 32A 5p, 2x230V	L/P (32A)	12 Modules	1/1	pcs
F3.0544	RB-300 - sockets 2x16A 5p, 2x230V	L/P (32A)	12 Modules	1/1	pcs
F3.0546	RB-300 - sockets 2x32A 5p, 2x230V	L/P (32A)	12 Modules	1/1	pcs

DISTRIBUTION BOXES R-190

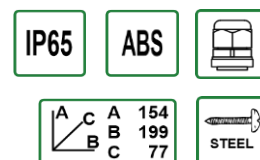

		Box	Unit
F3.0327	R-190 - sockets 16A 5p, 230V	1/1	pcs
F3.0328	R-190 - sockets 32A 5p, 230V	1/1	pcs
F3.0329	R-190 - sockets 2x230V	1/1	pcs

DISTRIBUTION BOXES R-240

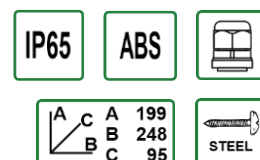

		Box	Unit
F3.0330	R-240 - sockets 16A 5p, 32A 5p	1/1	pcs
F3.0331	R-240 - sockets 2x16A 5p	1/1	pcs
F3.0332	R-240 - sockets 2x32A 5p	1/1	pcs
F3.0333	R-240 - sockets 16A 5p, 2x230V	1/1	pcs
F3.0334	R-240 - sockets 32A 5p, 2x230V	1/1	pcs

DISTRIBUTION BOXES R-300

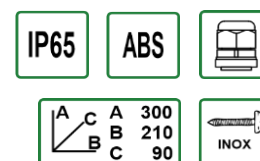

		Op.	J.m.
F3.1843	R-300 - gniazda 16A 5p, 32A 5p, 2x230V	1/1	pcs
F3.1844	R-300 - gniazda 2x16A 5p, 2x230V	1/1	pcs
F3.1845	R-300 - gniazda 2x32A 5p, 2x230V	1/1	pcs
F3.1846	R-300 - gniazda 16A 5p, 32A 5p, 4x230V	1/1	pcs
F3.1847	R-300 - gniazda 2x16A 5p, 4x230V	1/1	pcs
F3.1848	R-300 - gniazda 2x32A 5p, 4x230V	1/1	pcs

DISTRIBUTION BOXES TRIBOX

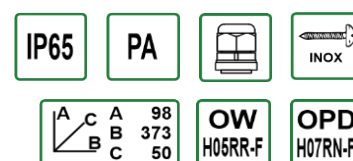

		Plug	Wire	Box	Unit
F3.0585	TRIBOX - sockets 3x16A 5p			1/1	pcs
F3.0586	TRIBOX - sockets 3x32A 5p			1/1	pcs
F3.0587	TRIBOX - sockets 2x16A 5p, 32A 5p			1/1	pcs
F3.0588	TRIBOX - sockets 16A 5p, 2x32A 5p			1/1	pcs
F3.0589	TRIBOX - sockets 3x16A 5p	16A 5p	/3m/ OW 5x2,5mm ²	1/1	pcs
F3.0590	TRIBOX - sockets 3x16A 5p	16A 5p	/5m/ OW 5x2,5mm ²	1/1	pcs
F3.0591	TRIBOX - sockets 3x16A 5p	16A 5p	/10m/ OW 5x2,5mm ²	1/1	pcs
F3.0592	TRIBOX - sockets 3x32A 5p	32A 5p	/3m/ OPD 5x4,0mm ²	1/1	pcs
F3.0593	TRIBOX - sockets 3x32A 5p	32A 5p	/5m/ OPD 5x4,0mm ²	1/1	pcs
F3.0594	TRIBOX - sockets 3x32A 5p	32A 5p	/10m/ OPD 5x4,0mm ²	1/1	pcs

DISTRIBUTION BOXES LAGO 5M



- F3.1828** LAGO 5M - sockets 16A 5p
- F3.1829** LAGO 5M - sockets 32A 5p

IP65	ABS PC	IK08	INOX											
<table border="1"> <tr><td>A</td><td>C</td><td>A</td><td>254</td></tr> <tr><td>B</td><td>B</td><td>B</td><td>120</td></tr> <tr><td>C</td><td>C</td><td>C</td><td>140</td></tr> </table>	A	C	A	254	B	B	B	120	C	C	C	140	N+PE	
A	C	A	254											
B	B	B	120											
C	C	C	140											

Modules	Box	Unit
5 Modules	1/1	pcs
5 Modules	1/1	pcs



- F3.1830** LAGO 5M - sockets 16A 5p, 230V
- F3.1831** LAGO 5M - sockets 32A 5p, 230V
- F3.1832** LAGO 5M - sockets 16A 5p, 2x230V
- F3.1833** LAGO 5M - sockets 32A 5p, 2x230V

IP65	ABS PC	IK08	INOX											
<table border="1"> <tr><td>A</td><td>C</td><td>A</td><td>254</td></tr> <tr><td>B</td><td>B</td><td>B</td><td>120</td></tr> <tr><td>C</td><td>C</td><td>C</td><td>140</td></tr> </table>	A	C	A	254	B	B	B	120	C	C	C	140	N+PE	
A	C	A	254											
B	B	B	120											
C	C	C	140											

Modules	Box	Unit
5 Modules	1/1	pcs
5 Modules	1/1	pcs
5 Modules	1/1	pcs
5 Modules	1/1	pcs

DISTRIBUTION BOXES LAGO 7M



- F3.0313** LAGO 7M - sockets 16A 5p
- F3.0314** LAGO 7M - sockets 32A 5p

IP65	ABS PC	IK08	INOX											
<table border="1"> <tr><td>A</td><td>C</td><td>A</td><td>254</td></tr> <tr><td>B</td><td>B</td><td>B</td><td>154</td></tr> <tr><td>C</td><td>C</td><td>C</td><td>138</td></tr> </table>	A	C	A	254	B	B	B	154	C	C	C	138	N+PE	
A	C	A	254											
B	B	B	154											
C	C	C	138											

Modules	Box	Unit
7 Modules	1/1	pcs
7 Modules	1/1	pcs



- F3.1784** LAGO 7M - sockets 16A 5p, 230V
- F3.1785** LAGO 7M - sockets 32A 5p, 230V
- F3.1786** LAGO 7M - sockets 16A 5p, 2x230V
- F3.1787** LAGO 7M - sockets 32A 5p, 2x230V

IP65	ABS PC	IK08	INOX											
<table border="1"> <tr><td>A</td><td>C</td><td>A</td><td>254</td></tr> <tr><td>B</td><td>B</td><td>B</td><td>154</td></tr> <tr><td>C</td><td>C</td><td>C</td><td>138</td></tr> </table>	A	C	A	254	B	B	B	154	C	C	C	138	N+PE	
A	C	A	254											
B	B	B	154											
C	C	C	138											

Modules	Box	Unit
7 Modules	1/1	pcs
7 Modules	1/1	pcs
7 Modules	1/1	pcs
7 Modules	1/1	pcs



- F3.1788** LAGO 7M - sockets 2x230V
- F3.1789** LAGO 7M - sockets 4x230V

IP65	ABS PC	IK08	INOX											
<table border="1"> <tr><td>A</td><td>C</td><td>A</td><td>254</td></tr> <tr><td>B</td><td>B</td><td>B</td><td>154</td></tr> <tr><td>C</td><td>C</td><td>C</td><td>138</td></tr> </table>	A	C	A	254	B	B	B	154	C	C	C	138	N+PE	
A	C	A	254											
B	B	B	154											
C	C	C	138											

Modules	Box	Unit
7 Modules	1/1	pcs
7 Modules	1/1	pcs

DISTRIBUTION BOXES LAGO 10M



IP65 ABS/PC IK08 INOX

A C A 300
B B 210
C C 122

N+PE

- F3.0318 LAGO 10M - sockets 2x16A 5p
- F3.0319 LAGO 10M - sockets 2x32A 5p
- F3.0320 LAGO 10M - sockets 16A 5p, 32A 5p

Modules	Box	Unit
10 Modules	1/1	pcs
10 Modules	1/1	pcs
10 Modules	1/1	pcs



IP65 ABS/PC IK08 INOX

A C A 300
B B 210
C C 122

N+PE

- F3.0321 LAGO 10M - sockets 16A 5p, 2x230V
- F3.0322 LAGO 10M - sockets 32A 5p, 2x230V
- F3.0315 LAGO 10M - sockets 16A 5p, 32A 5p, 2x230V
- F3.0316 LAGO 10M - sockets 2x16A 5p, 2x230V
- F3.0317 LAGO 10M - sockets 2x32A 5p, 2x230V

Modules	Box	Unit
10 Modules	1/1	pcs
10 Modules	1/1	pcs
10 Modules	1/1	pcs
10 Modules	1/1	pcs
10 Modules	1/1	pcs



IP65 ABS/PC IK08 INOX

A C A 300
B B 210
C C 122

N+PE

- F3.1790 LAGO 10M - sockets 63A 5p
- F3.1791 LAGO 10M - sockets 63A 5p, 230V

Modules	Box	Unit
10 Modules	1/1	pcs
10 Modules	1/1	pcs



IP65 ABS/PC IK08 INOX

A C A 300
B B 210
C C 122

N+PE

- F3.1798 LAGO 10M - sockets 2x230V
- F3.1792 LAGO 10M - sockets 3x230V
- F3.1793 LAGO 10M - sockets 4x230V

Modules	Box	Unit
10 Modules	1/1	pcs
10 Modules	1/1	pcs
10 Modules	1/1	pcs



IP65 ABS/PC IK08 INOX

A C A 300
B B 210
C C 122

N+PE

- F3.1794 LAGO 10M - sockets 5x230V
- F3.1795 LAGO 10M - sockets 6x230V

Modules	Box	Unit
10 Modules	1/1	pcs
10 Modules	1/1	pcs

DISTRIBUTION BOXES R-240 4M



IP65	ABS PC	IK08	PLASTIC												
<table border="1"> <tr><td>A</td><td>C</td><td>A</td><td>240</td></tr> <tr><td>B</td><td></td><td>B</td><td>190</td></tr> <tr><td></td><td></td><td>C</td><td>90</td></tr> </table>	A	C	A	240	B		B	190			C	90	N+PE		
A	C	A	240												
B		B	190												
		C	90												

- F3.0323 R-240 4M - sockets 16A 5p, 2x230V
- F3.0324 R-240 4M - sockets 32A 5p, 2x230V

Modules	Box	Unit
4 Modules	1/1	pcs
4 Modules	1/1	pcs

DISTRIBUTION BOXES R-240 8M



IP65	ABS PC	IK08	PLASTIC												
<table border="1"> <tr><td>A</td><td>C</td><td>A</td><td>240</td></tr> <tr><td>B</td><td></td><td>B</td><td>190</td></tr> <tr><td></td><td></td><td>C</td><td>90</td></tr> </table>	A	C	A	240	B		B	190			C	90	N+PE		
A	C	A	240												
B		B	190												
		C	90												

- F3.0325 R-240 8M - sockets 16A 5p, 230V
- F3.0326 R-240 8M - sockets 32A 5p, 230V

Modules	Box	Unit
8 Modules	1/1	pcs
8 Modules	1/1	pcs

DISTRIBUTION BOXES CAJA 9M



IP65	ABS PC	IK08	HALOGEN FREE												
<table border="1"> <tr><td>A</td><td>C</td><td>A</td><td>342</td></tr> <tr><td>B</td><td></td><td>B</td><td>215</td></tr> <tr><td></td><td></td><td>C</td><td>155</td></tr> </table>	A	C	A	342	B		B	215			C	155	N+PE		PLASTIC
A	C	A	342												
B		B	215												
		C	155												

- F3.0310 CAJA 9M - sockets 16A 5p, 32A 5p, 2x230V
- F3.0311 CAJA 9M - sockets 2x16A 5p, 2x230V
- F3.0312 CAJA 9M - sockets 2x32A 5p, 2x230V

Modules	Box	Unit
9 Modules	1/1	pcs
9 Modules	1/1	pcs
9 Modules	1/1	pcs

DISTRIBUTION BOXES CAJA 12M



IP65	ABS PC	IK08	INOX												
<table border="1"> <tr><td>A</td><td>C</td><td>A</td><td>330</td></tr> <tr><td>B</td><td></td><td>B</td><td>240</td></tr> <tr><td></td><td></td><td>C</td><td>140</td></tr> </table>	A	C	A	330	B		B	240			C	140	N+PE		
A	C	A	330												
B		B	240												
		C	140												

- F3.1438 CAJA 12M - sockets 16A 5p, 32A 5p, 2x230V
- F3.1589 CAJA 12M - sockets 2x16A 5p, 2x230V
- F3.1835 CAJA 12M - sockets 2x32A 5p, 2x230V

Modules	Box	Unit
12 Modules	1/1	pcs
12 Modules	1/1	pcs
12 Modules	1/1	pcs

DISTRIBUTION BOXES ULISSE 12M

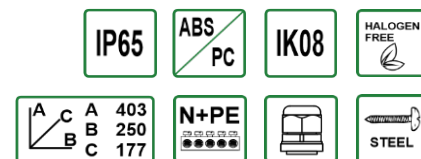

		Modules	Box	Unit
74185.1	ULISSE 12M - sockets 16A 5p, 32A 5p, 2x230V	12 Modules	1/1	pcs
74185.3	ULISSE 12M - sockets 2x16A 5p, 2x230V	12 Modules	1/1	pcs
74185.5	ULISSE 12M - sockets 2x32A 5p, 2x230V	12 Modules	1/1	pcs
74185.2	ULISSE 12M - sockets 2x16A 5p, 3x230V	12 Modules	1/1	pcs
74185.4	ULISSE 12M - sockets 2x32A 5p, 3x230V	12 Modules	1/1	pcs

DISTRIBUTION BOXES ULISSE 17M

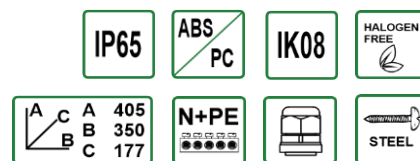

		Modules	Box	Unit
74186.0	ULISSE 17M - sockets 16A 5p, 2x32A 5p, 4x230V	17 Modules	1/1	pcs
74186.1	ULISSE 17M - sockets 2x16A 5p, 32A 5p, 4x230V	17 Modules	1/1	pcs
74186.2	ULISSE 17M - sockets 3x16A 5p, 4x230V	17 Modules	1/1	pcs
74186.3	ULISSE 17M - sockets 3x32A 5p, 4x230V	17 Modules	1/1	pcs

DISTRIBUTION BOXES FEMO 13M

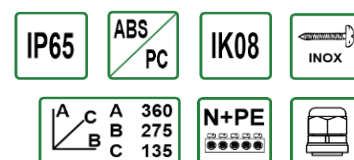

		Modules	Box	Unit
74187.14	FEMO 13M - sockets 16A 5p, 32A 5p, 2x230V	13 Modules	1/1	pcs
74187.24	FEMO 13M - sockets 2x16A 5p, 2x230V	13 Modules	1/1	pcs
74187.25	FEMO 13M - sockets 2x32A 5p, 2x230V	13 Modules	1/1	pcs
74187.0	FEMO 13M - sockets 16A 5p, 32A 5p, 3x230V	13 Modules	1/1	pcs
74187.1	FEMO 13M - sockets 2x16A 5p, 3x230V	13 Modules	1/1	pcs
74187.2	FEMO 13M - sockets 2x32A 5p, 3x230V	13 Modules	1/1	pcs

DISTRIBUTION BOXES LEGATO 16M

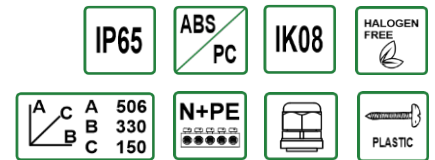

		Modules	Box	Unit
75101.0	LEGATO 16M - sockets 2x16A 5p, 2x32A 5p, 3x230V	16 Modules	1/1	pcs
75101.1	LEGATO 16M - sockets 4x16A 5p, 3x230V	16 Modules	1/1	pcs
75101.2	LEGATO 16M - sockets 4x32A 5p, 3x230V	16 Modules	1/1	pcs
75101.3	LEGATO 16M - sockets 3x16A 5p, 4x230V	16 Modules	1/1	pcs
75101.4	LEGATO 16M - sockets 3x32A 5p, 4x230V	16 Modules	1/1	pcs

DISTRIBUTION BOXES LEGATO 32M

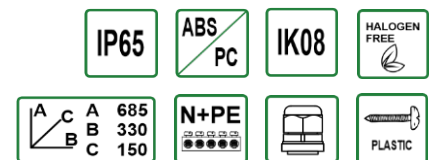

		Modules	Box	Unit
75102.0	LEGATO 32M - sockets 2x16A 5p, 2x32A 5p, 3x230V	32 Modules	1/1	pcs
75102.1	LEGATO 32M - sockets 4x16A 5p, 3x230V	32 Modules	1/1	pcs
75102.2	LEGATO 32M - sockets 4x32A 5p, 3x230V	32 Modules	1/1	pcs
75102.3	LEGATO 32M - sockets 3x16A 5p, 4x230V	32 Modules	1/1	pcs
75102.4	LEGATO 32M - sockets 3x32A 5p, 4x230V	32 Modules	1/1	pcs



Intended for
FEMO 13M
FEMO 18M
LAGO 14M
LAGO 17M
LEGATO 16M
LEGATO 32M
CAJA 12M
CAJA 26M
ULISSE 12M
ULISSE 17M



Material: powder coated steel

Material: powder coated steel

		Box	Unit
74996	Metal frame 430x1010	1/1	pcs
74989	Metal frame 780x1010	1/1	pcs



Intended for
ULISSE 12M
ULISSE 17M



Intended for
BICO
R-240
R-300
R-240 4M
R-240 8M
LAGO 5M
LAGO 6M
LAGO 7M
LAGO 10M
LAGO 11M
ULISSE 6M MINI
ULISSE 11M

Material: galvanized steel

Material: powder coated steel

		Box	Unit
74993	Metal frame for distribution box 350x575	1/1	pcs
74987	Metal frame for distribution box 360x300	1/1	pcs



		Dimensions	Box	Unit
74999	Plastic frame	85x250x260 mm	1/1	pcs
74998	Metal frame	71x210x180 mm	1/1	pcs

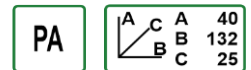

		Box	Unit
74992	Handle for distribution board	1/1	pcs



		Diameter assembly	Lenght socket	U _[V]	I _[A]	Box	Unit
74991	Fuse socket	13 mm	37 mm	230	10	1/1	pcs
74990	Ceramic fuse 10A	Ø 5 x 20	fusible			1/1	pcs

CARAVAN SYSTEMS 230V



IP44	PA	Ms58	IK07
------	----	------	------

U [V] 200-250	I [A] 16	Hz 50-60
------------------	-------------	-------------

- | | | Box | Unit |
|-------|---|------|------|
| 73109 | Adaptor for industrial purposes plug 16A 3p, 230V | 1/12 | pcs |
| 73001 | Adaptor for industrial purposes plug 230V Uni-schuko, socket 16A 3p | 1/12 | pcs |



IP44	PA	Ms58	IK07
------	----	------	------

U [V] 200-250	I [A] 16	Hz 50-60
------------------	-------------	-------------

- | | | Box | Unit |
|-------|--|-----|------|
| 73117 | Adaptor for industrial purposes plug 16A 3p, socket 16A 3P, 230V | 1/6 | pcs |
| 73115 | Adaptor for industrial purposes plug 16A 3p, socket 2x230V | 1/6 | pcs |



IP44	PA	Ms58	IK07
------	----	------	------

U [V] 200-250	I [A] 16	Hz 50-60
------------------	-------------	-------------

- | | | Box | Unit |
|-------|--|-----|------|
| 73110 | Adaptor for industrial purposes plug 16A 3p, socket 2x16A 3p with handle | 1/6 | pcs |
| 73105 | Adaptor for industrial purposes plug 16A 3p, socket 2x16A 3P | 1/6 | pcs |



PA	Ms58	IK07
----	------	------

U [V] 200-250	I [A] 16	Hz 50-60
------------------	-------------	-------------

Protection

- | | | class | Box | Unit |
|-------|---|-------|-----|------|
| 73126 | Multi-way adaptor for industrial purposes plug 16A 3p, socket 2x16A 3P, 230V | IP44 | 1/6 | pcs |
| 73120 | Multi-way adaptor for industrial purposes plug 16A 3p IP67, 3 sockets 3x 16A 3p | IP67 | 1/6 | pcs |

ADAPTER 230V



IP44 OW
H05RR-F

		Wire	Box	Unit
F7.0121	Adopting from industrial plug 16A 3p to industrial socket 16A 250V	/0,5m/ OW 3x2,5mm ²	1/1	pcs
F7.0122	Adopting from industrial plug 16A 250V to industrial socket 16A 3p	/0,5m/ OW 3x2,5mm ²	1/1	pcs

ADAPTER 400/230V



IP44 OW
H05RR-F

		Wire	Box	Unit
F7.0124	Adopting from industrial plug 16A 5p to industrial socket 16A 250V	/0,25m/ OW 3x1,5mm ²	1/1	pcs
F7.0125	Adopting from industrial plug 16A 5p to industrial socket 2x16A 250V	/0,25m/ OW 3x1,5mm ²	1/1	pcs
F7.0126	Adopting from industrial plug 16A 5p to industrial socket 3x16A 250V	/0,25m/ OW 3x1,5mm ²	1/1	pcs

ADAPTER 400V



IP44 OW
H05RR-F

		Wire	Box	Unit
F7.0123	Adopting from industrial plug 16A 5p to industrial socket 32A 5p	/0,25m/ OW 5x2,5mm ²	1/1	pcs



IP44 PA Ms58

		Box	Unit
F7.0023	Adapter – change from industrial plug 16A 4p to industrial socket 32A 4p	1/8	pcs
F7.0024	Adapter – change from industrial plug 16A 5p to industrial socket 16A 4p	1/9	pcs
F7.0025	Adapter – change from industrial plug 16A 5p to industrial socket 32A 5p	1/8	pcs
F7.0026	Adapter – change from industrial plug 32A 5p to industrial socket 32A 4p	1/6	pcs

CABLE EXTENSION WITH PLUG AND SOCKET



Type of plug: uni-schuko

		Lenght	Type of sockets	Box	Unit
92971-5	Cable extension 1x230V OW 3x1,5	5m	2P+Z	1/1	pcs
92971-10	Cable extension 1x230V OW 3x1,5	10m	2P+Z	1/1	pcs
92971-15	Cable extension 1x230V OW 3x1,5	15m	2P+Z	1/1	pcs
92971-20	Cable extension 1x230V OW 3x1,5	20m	2P+Z	1/1	pcs
92971-25	Cable extension 1x230V OW 3x1,5	25m	2P+Z	1/1	pcs
92971-30	Cable extension 1x230V OW 3x1,5	30m	2P+Z	1/1	pcs
92971-40	Cable extension 1x230V OW 3x1,5	40m	2P+Z	1/1	pcs
92971-50	Cable extension 1x230V OW 3x1,5	50m	2P+Z	1/1	pcs
92971-5A	Cable extension 1x230V OW 3x2,5	5m	2P+Z	1/1	pcs
92971-10A	Cable extension 1x230V OW 3x2,5	10m	2P+Z	1/1	pcs
92971-15A	Cable extension 1x230V OW 3x2,5	15m	2P+Z	1/1	pcs
92971-20A	Cable extension 1x230V OW 3x2,5	20m	2P+Z	1/1	pcs
92971-25A	Cable extension 1x230V OW 3x2,5	25m	2P+Z	1/1	pcs
92971-30A	Cable extension 1x230V OW 3x2,5	30m	2P+Z	1/1	pcs
92971-40A	Cable extension 1x230V OW 3x2,5	40m	2P+Z	1/1	pcs
92971-50A	Cable extension 1x230V OW 3x2,5	50m	2P+Z	1/1	pcs

CABLE EXTENSION WITH PLUG AND SOCKETS



Type of plug: uni-schuko

		Lenght	Type of sockets	Box	Unit
92976-5	Cable extension 3x230V OW 3x1,5	5m	3x2P+Z	1/1	pcs
92976-10	Cable extension 3x230V OW 3x1,5	10m	3x2P+Z	1/1	pcs
92976-15	Cable extension 3x230V OW 3x1,5	15m	3x2P+Z	1/1	pcs
92976-20	Cable extension 3x230V OW 3x1,5	20m	3x2P+Z	1/1	pcs
92976-25	Cable extension 3x230V OW 3x1,5	25m	3x2P+Z	1/1	pcs
92976-30	Cable extension 3x230V OW 3x1,5	30m	3x2P+Z	1/1	pcs
92976-40	Cable extension 3x230V OW 3x1,5	40m	3x2P+Z	1/1	pcs
92976-50	Cable extension 3x230V OW 3x1,5	50m	3x2P+Z	1/1	pcs
92976-5A	Cable extension 3x230V OW 3x2,5	5m	3x2P+Z	1/1	pcs
92976-10A	Cable extension 3x230V OW 3x2,5	10m	3x2P+Z	1/1	pcs
92976-15A	Cable extension 3x230V OW 3x2,5	15m	3x2P+Z	1/1	pcs
92976-20A	Cable extension 3x230V OW 3x2,5	20m	3x2P+Z	1/1	pcs
92976-25A	Cable extension 3x230V OW 3x2,5	25m	3x2P+Z	1/1	pcs
92976-30A	Cable extension 3x230V OW 3x2,5	30m	3x2P+Z	1/1	pcs
92976-40A	Cable extension 3x230V OW 3x2,5	40m	3x2P+Z	1/1	pcs
92976-50A	Cable extension 3x230V OW 3x2,5	50m	3x2P+Z	1/1	pcs

SURFACE MOUNTED RUBBER SOCKET



IP44
U [V] 230
I [A] 16
P [W] 3500
Typ E
OW H05RR-F

Type of plug: uni-schuko

		Lenght	Type of sockets	Box	Unit
22975-1	Cable extension 2x230V OW 3x1,5	3m	2P+Z	1/1	pcs
22975-2	Cable extension 2x230V OW 3x1,5	5m	2P+Z	1/1	pcs
22975-3	Cable extension 2x230V OW 3x1,5	10m	2P+Z	1/1	pcs
22975-4	Cable extension 2x230V OW 3x1,5	15m	2P+Z	1/1	pcs
22975-5	Cable extension 2x230V OW 3x1,5	20m	2P+Z	1/1	pcs
22975-6	Cable extension 2x230V OW 3x1,5	25m	2P+Z	1/1	pcs
22975-7	Cable extension 2x230V OW 3x1,5	30m	2P+Z	1/1	pcs
22975-8	Cable extension 2x230V OW 3x1,5	40m	2P+Z	1/1	pcs
22975-9	Cable extension 2x230V OW 3x1,5	50m	2P+Z	1/1	pcs
32975-1	Cable extension 2x230V OW 3x2,5	3m	2P+Z	1/1	pcs
32975-2	Cable extension 2x230V OW 3x2,5	5m	2P+Z	1/1	pcs
32975-3	Cable extension 2x230V OW 3x2,5	10m	2P+Z	1/1	pcs
32975-4	Cable extension 2x230V OW 3x2,5	15m	2P+Z	1/1	pcs
32975-5	Cable extension 2x230V OW 3x2,5	20m	2P+Z	1/1	pcs
32975-6	Cable extension 2x230V OW 3x2,5	25m	2P+Z	1/1	pcs
32975-7	Cable extension 2x230V OW 3x2,5	30m	2P+Z	1/1	pcs
32975-8	Cable extension 2x230V OW 3x2,5	40m	2P+Z	1/1	pcs
32975-9	Cable extension 2x230V OW 3x2,5	50m	2P+Z	1/1	pcs



IP44
U [V] 230
I [A] 16
P [W] 3500
Typ E
OPD H07RN-F

Type of plug: uni-schuko

		Lenght	Type of sockets	Box	Unit
22977-1	Cable extension 2x230V OPD 3x1,5	3m	2P+Z	1/1	pcs
22977-2	Cable extension 2x230V OPD 3x1,5	5m	2P+Z	1/1	pcs
22977-3	Cable extension 2x230V OPD 3x1,5	10m	2P+Z	1/1	pcs
22977-4	Cable extension 2x230V OPD 3x1,5	15m	2P+Z	1/1	pcs
22977-5	Cable extension 2x230V OPD 3x1,5	20m	2P+Z	1/1	pcs
22977-6	Cable extension 2x230V OPD 3x1,5	25m	2P+Z	1/1	pcs
22977-7	Cable extension 2x230V OPD 3x1,5	30m	2P+Z	1/1	pcs
22977-8	Cable extension 2x230V OPD 3x1,5	40m	2P+Z	1/1	pcs
22977-9	Cable extension 2x230V OPD 3x1,5	50m	2P+Z	1/1	pcs
32977-1	Cable extension 2x230V OPD 3x2,5	3m	2P+Z	1/1	pcs
32977-2	Cable extension 2x230V OPD 3x2,5	5m	2P+Z	1/1	pcs
32977-3	Cable extension 2x230V OPD 3x2,5	10m	2P+Z	1/1	pcs
32977-4	Cable extension 2x230V OPD 3x2,5	15m	2P+Z	1/1	pcs
32977-5	Cable extension 2x230V OPD 3x2,5	20m	2P+Z	1/1	pcs
32977-6	Cable extension 2x230V OPD 3x2,5	25m	2P+Z	1/1	pcs
32977-7	Cable extension 2x230V OPD 3x2,5	30m	2P+Z	1/1	pcs
32977-8	Cable extension 2x230V OPD 3x2,5	40m	2P+Z	1/1	pcs
32977-9	Cable extension 2x230V OPD 3x2,5	50m	2P+Z	1/1	pcs



Type of plug: uni-schuko

		Lenght	Type of sockets	Box	Unit
23975-1	Cable extension 3x230V OW 3x1,5	3m	3x2P+Z	1/1	pcs
23975-2	Cable extension 3x230V OW 3x1,5	5m	3x2P+Z	1/1	pcs
23975-3	Cable extension 3x230V OW 3x1,5	10m	3x2P+Z	1/1	pcs
23975-4	Cable extension 3x230V OW 3x1,5	15m	3x2P+Z	1/1	pcs
23975-5	Cable extension 3x230V OW 3x1,5	20m	3x2P+Z	1/1	pcs
23975-6	Cable extension 3x230V OW 3x1,5	25m	3x2P+Z	1/1	pcs
23975-7	Cable extension 3x230V OW 3x1,5	30m	3x2P+Z	1/1	pcs
23975-8	Cable extension 3x230V OW 3x1,5	40m	3x2P+Z	1/1	pcs
23975-9	Cable extension 3x230V OW 3x1,5	50m	3x2P+Z	1/1	pcs
33975-1	Cable extension 3x230V OW 3x2,5	3m	3x2P+Z	1/1	pcs
33975-2	Cable extension 3x230V OW 3x2,5	5m	3x2P+Z	1/1	pcs
33975-3	Cable extension 3x230V OW 3x2,5	10m	3x2P+Z	1/1	pcs
33975-4	Cable extension 3x230V OW 3x2,5	15m	3x2P+Z	1/1	pcs
33975-5	Cable extension 3x230V OW 3x2,5	20m	3x2P+Z	1/1	pcs
33975-6	Cable extension 3x230V OW 3x2,5	25m	3x2P+Z	1/1	pcs
33975-7	Cable extension 3x230V OW 3x2,5	30m	3x2P+Z	1/1	pcs
33975-8	Cable extension 3x230V OW 3x2,5	40m	3x2P+Z	1/1	pcs
33975-9	Cable extension 3x230V OW 3x2,5	50m	3x2P+Z	1/1	pcs



Type of plug: uni-schuko

		Lenght	Type of sockets	Box	Unit
23977-1	Cable extension 3x230V OPD 3x1,5	3m	3x2P+Z	1/1	pcs
23977-2	Cable extension 3x230V OPD 3x1,5	5m	3x2P+Z	1/1	pcs
23977-3	Cable extension 3x230V OPD 3x1,5	10m	3x2P+Z	1/1	pcs
23977-4	Cable extension 3x230V OPD 3x1,5	15m	3x2P+Z	1/1	pcs
23977-5	Cable extension 3x230V OPD 3x1,5	20m	3x2P+Z	1/1	pcs
23977-6	Cable extension 3x230V OPD 3x1,5	25m	3x2P+Z	1/1	pcs
23977-7	Cable extension 3x230V OPD 3x1,5	30m	3x2P+Z	1/1	pcs
23977-8	Cable extension 3x230V OPD 3x1,5	40m	3x2P+Z	1/1	pcs
23977-9	Cable extension 3x230V OPD 3x1,5	50m	3x2P+Z	1/1	pcs
33977-1	Cable extension 3x230V OPD 3x2,5	3m	3x2P+Z	1/1	pcs
33977-2	Cable extension 3x230V OPD 3x2,5	5m	3x2P+Z	1/1	pcs
33977-3	Cable extension 3x230V OPD 3x2,5	10m	3x2P+Z	1/1	pcs
33977-4	Cable extension 3x230V OPD 3x2,5	15m	3x2P+Z	1/1	pcs
33977-5	Cable extension 3x230V OPD 3x2,5	20m	3x2P+Z	1/1	pcs
33977-6	Cable extension 3x230V OPD 3x2,5	25m	3x2P+Z	1/1	pcs
33977-7	Cable extension 3x230V OPD 3x2,5	30m	3x2P+Z	1/1	pcs
33977-8	Cable extension 3x230V OPD 3x2,5	40m	3x2P+Z	1/1	pcs
33977-9	Cable extension 3x230V OPD 3x2,5	50m	3x2P+Z	1/1	pcs

SURFACE MOUNTED RUBBER SOCKET



IP44
U [V] 230
I [A] 16
P [W] 3500
Typ E
OW H05RR-F

Type of plug: uni-schuko

		Lenght	Type of sockets	Box	Unit
24975-1	Cable extension 4x230V OW 3x1,5	3m	4x2P+Z	1/1	pcs
24975-2	Cable extension 4x230V OW 3x1,5	5m	4x2P+Z	1/1	pcs
24975-3	Cable extension 4x230V OW 3x1,5	10m	4x2P+Z	1/1	pcs
24975-4	Cable extension 4x230V OW 3x1,5	15m	4x2P+Z	1/1	pcs
24975-5	Cable extension 4x230V OW 3x1,5	20m	4x2P+Z	1/1	pcs
24975-6	Cable extension 4x230V OW 3x1,5	25m	4x2P+Z	1/1	pcs
24975-7	Cable extension 4x230V OW 3x1,5	30m	4x2P+Z	1/1	pcs
24975-8	Cable extension 4x230V OW 3x1,5	40m	4x2P+Z	1/1	pcs
24975-9	Cable extension 4x230V OW 3x1,5	50m	4x2P+Z	1/1	pcs
34975-1	Cable extension 4x230V OW 3x2,5	3m	4x2P+Z	1/1	pcs
34975-2	Cable extension 4x230V OW 3x2,5	5m	4x2P+Z	1/1	pcs
34975-3	Cable extension 4x230V OW 3x2,5	10m	4x2P+Z	1/1	pcs
34975-4	Cable extension 4x230V OW 3x2,5	15m	4x2P+Z	1/1	pcs
34975-5	Cable extension 4x230V OW 3x2,5	20m	4x2P+Z	1/1	pcs
34975-6	Cable extension 4x230V OW 3x2,5	25m	4x2P+Z	1/1	pcs
34975-7	Cable extension 4x230V OW 3x2,5	30m	4x2P+Z	1/1	pcs
34975-8	Cable extension 4x230V OW 3x2,5	40m	4x2P+Z	1/1	pcs
34975-9	Cable extension 4x230V OW 3x2,5	50m	4x2P+Z	1/1	pcs



IP44
U [V] 230
I [A] 16
P [W] 3500
Typ E
OPD H07RN-F

Type of plug: uni-schuko

		Lenght	Type of sockets	Box	Unit
24977-1	Cable extension 4x230V OPD 3x1,5	3m	4x2P+Z	1/1	pcs
24977-2	Cable extension 4x230V OPD 3x1,5	5m	4x2P+Z	1/1	pcs
24977-3	Cable extension 4x230V OPD 3x1,5	10m	4x2P+Z	1/1	pcs
24977-4	Cable extension 4x230V OPD 3x1,5	15m	4x2P+Z	1/1	pcs
24977-5	Cable extension 4x230V OPD 3x1,5	20m	4x2P+Z	1/1	pcs
24977-6	Cable extension 4x230V OPD 3x1,5	25m	4x2P+Z	1/1	pcs
24977-7	Cable extension 4x230V OPD 3x1,5	30m	4x2P+Z	1/1	pcs
24977-8	Cable extension 4x230V OPD 3x1,5	40m	4x2P+Z	1/1	pcs
24977-9	Cable extension 4x230V OPD 3x1,5	50m	4x2P+Z	1/1	pcs
34977-1	Cable extension 4x230V OPD 3x2,5	3m	4x2P+Z	1/1	pcs
34977-2	Cable extension 4x230V OPD 3x2,5	5m	4x2P+Z	1/1	pcs
34977-3	Cable extension 4x230V OPD 3x2,5	10m	4x2P+Z	1/1	pcs
34977-4	Cable extension 4x230V OPD 3x2,5	15m	4x2P+Z	1/1	pcs
34977-5	Cable extension 4x230V OPD 3x2,5	20m	4x2P+Z	1/1	pcs
34977-6	Cable extension 4x230V OPD 3x2,5	25m	4x2P+Z	1/1	pcs
34977-7	Cable extension 4x230V OPD 3x2,5	30m	4x2P+Z	1/1	pcs
34977-8	Cable extension 4x230V OPD 3x2,5	40m	4x2P+Z	1/1	pcs
34977-9	Cable extension 4x230V OPD 3x2,5	50m	4x2P+Z	1/1	pcs

CABLE EXTENSION WITH PLUG AND SOCKET



IP44	U ^[V] 400	I ^[A] 16	OW H05RR-F
------	-------------------------	------------------------	---------------

		Lenght	Plug	Socket	Box	Unit
92973-10	Cable extension OW 5x2,5	10m	16A 5p	16A 5p	1/1	pcs
92973-15	Cable extension OW 5x2,5	15m	16A 5p	16A 5p	1/1	pcs
92973-20	Cable extension OW 5x2,5	20m	16A 5p	16A 5p	1/1	pcs
92973-25	Cable extension OW 5x2,5	25m	16A 5p	16A 5p	1/1	pcs
92973-30	Cable extension OW 5x2,5	30m	16A 5p	16A 5p	1/1	pcs



IP44	U ^[V] 400	I ^[A] 32	OPD H07RN-F
------	-------------------------	------------------------	----------------

		Lenght	Plug	Socket	Box	Unit
92972-10	Cable extension OPD 5x4	10m	32A 5p	32A 5p	1/1	pcs
92972-15	Cable extension OPD 5x4	15m	32A 5p	32A 5p	1/1	pcs
92972-20	Cable extension OPD 5x4	20m	32A 5p	32A 5p	1/1	pcs
92972-25	Cable extension OPD 5x4	25m	32A 5p	32A 5p	1/1	pcs
92972-30	Cable extension OPD 5x4	30m	32A 5p	32A 5p	1/1	pcs



IP65	U ^[V] 400	I ^[A] 16	OPD H07RN-F
------	-------------------------	------------------------	----------------

		Lenght	Plug	Socket	Box	Unit
92975-10	Cable extension OPD 5x2,5	10m	16A 5p	16A 5p	1/1	pcs
92975-15	Cable extension OPD 5x2,5	15m	16A 5p	16A 5p	1/1	pcs
92975-20	Cable extension OPD 5x2,5	20m	16A 5p	16A 5p	1/1	pcs
92975-25	Cable extension OPD 5x2,5	25m	16A 5p	16A 5p	1/1	pcs
92975-30	Cable extension OPD 5x2,5	30m	16A 5p	16A 5p	1/1	pcs



IP65	U ^[V] 400	I ^[A] 32	OPD H07RN-F
------	-------------------------	------------------------	----------------

		Lenght	Plug	Socket	Box	Unit
92978-10	Cable extension OPD 5x4	10m	32A 5p	32A 5p	1/1	pcs
92978-15	Cable extension OPD 5x4	15m	32A 5p	32A 5p	1/1	pcs
92978-20	Cable extension OPD 5x4	20m	32A 5p	32A 5p	1/1	pcs
92978-25	Cable extension OPD 5x4	25m	32A 5p	32A 5p	1/1	pcs
92978-30	Cable extension OPD 5x4	30m	32A 5p	32A 5p	1/1	pcs

PLASTIC CABLE REELS FILO-230



Type of plug: rubber

		Lenght	Equipment	Box	Unit
14508-2	Cable reel FILO-230 OW 3x1,5 4x230V	15m	thermal fuse	1/1	pcs
14508-3	Cable reel FILO-230 OW 3x1,5 4x230V	20m	thermal fuse	1/1	pcs
14508-4	Cable reel FILO-230 OW 3x1,5 4x230V	25m	thermal fuse	1/1	pcs
14508-5	Cable reel FILO-230 OW 3x1,5 4x230V	30m	thermal fuse	1/1	pcs
14508-12	Cable reel FILO-230 OW 3x2,5 4x230V	15m	thermal fuse	1/1	pcs
14508-13	Cable reel FILO-230 OW 3x2,5 4x230V	20m	thermal fuse	1/1	pcs
14508-14	Cable reel FILO-230 OW 3x2,5 4x230V	25m	thermal fuse	1/1	pcs
14508-22	Cable reel FILO-230 OPD 3x1,5 4x230V	15m	thermal fuse	1/1	pcs
14508-23	Cable reel FILO-230 OPD 3x1,5 4x230V	20m	thermal fuse	1/1	pcs
14508-24	Cable reel FILO-230 OPD 3x1,5 4x230V	25m	thermal fuse	1/1	pcs
14508-25	Cable reel FILO-230 OPD 3x1,5 4x230V	30m	thermal fuse	1/1	pcs
14508-32	Cable reel FILO-230 OPD 3x2,5 4x230V	15m	thermal fuse	1/1	pcs
14508-33	Cable reel FILO-230 OPD 3x2,5 4x230V	20m	thermal fuse	1/1	pcs
14508-34	Cable reel FILO-230 OPD 3x2,5 4x230V	25m	thermal fuse	1/1	pcs
14508-42	Cable reel FILO-230 OWY 3x1,5 4x230V	15m	thermal fuse	1/1	pcs
14508-43	Cable reel FILO-230 OWY 3x1,5 4x230V	20m	thermal fuse	1/1	pcs
14508-44	Cable reel FILO-230 OWY 3x1,5 4x230V	25m	thermal fuse	1/1	pcs
14508-45	Cable reel FILO-230 OWY 3x1,5 4x230V	30m	thermal fuse	1/1	pcs

PLASTIC CABLE REELS FILO-260



Type of plug: rubber

		Lenght	Equipment	Box	Unit
14688-2	Cable reel FILO-260 OW 3x1,5 4x230V	15m	thermal fuse	1/1	pcs
14688-3	Cable reel FILO-260 OW 3x1,5 4x230V	20m	thermal fuse	1/1	pcs
14688-4	Cable reel FILO-260 OW 3x1,5 4x230V	25m	thermal fuse	1/1	pcs
14688-5	Cable reel FILO-260 OW 3x1,5 4x230V	30m	thermal fuse	1/1	pcs
14688-6	Cable reel FILO-260 OW 3x1,5 4x230V	35m	thermal fuse	1/1	pcs
14688-7	Cable reel FILO-260 OW 3x1,5 4x230V	40m	thermal fuse	1/1	pcs
14688-8	Cable reel FILO-260 OW 3x1,5 4x230V	50m	thermal fuse	1/1	pcs

PLASTIC CABLE REELS FILO-260



Type of plug: rubber

		Lenght	Equipment	Box	Unit
14688-12	Cable reel FILO-260 OW 3x2,5 4x230V	15m	thermal fuse	1/1	pcs
14688-13	Cable reel FILO-260 OW 3x2,5 4x230V	20m	thermal fuse	1/1	pcs
14688-14	Cable reel FILO-260 OW 3x2,5 4x230V	25m	thermal fuse	1/1	pcs
14688-15	Cable reel FILO-260 OW 3x2,5 4x230V	30m	thermal fuse	1/1	pcs
14688-16	Cable reel FILO-260 OW 3x2,5 4x230V	35m	thermal fuse	1/1	pcs
14688-17	Cable reel FILO-260 OW 3x2,5 4x230V	40m	thermal fuse	1/1	pcs
14688-22	Cable reel FILO-260 OPD 3x1,5 4x230V	15m	thermal fuse	1/1	pcs
14688-23	Cable reel FILO-260 OPD 3x1,5 4x230V	20m	thermal fuse	1/1	pcs
14688-24	Cable reel FILO-260 OPD 3x1,5 4x230V	25m	thermal fuse	1/1	pcs
14688-25	Cable reel FILO-260 OPD 3x1,5 4x230V	30m	thermal fuse	1/1	pcs
14688-26	Cable reel FILO-260 OPD 3x1,5 4x230V	35m	thermal fuse	1/1	pcs
14688-27	Cable reel FILO-260 OPD 3x1,5 4x230V	40m	thermal fuse	1/1	pcs
14688-28	Cable reel FILO-260 OPD 3x1,5 4x230V	50m	thermal fuse	1/1	pcs
14688-32	Cable reel FILO-260 OPD 3x2,5 4x230V	15m	thermal fuse	1/1	pcs
14688-33	Cable reel FILO-260 OPD 3x2,5 4x230V	20m	thermal fuse	1/1	pcs
14688-34	Cable reel FILO-260 OPD 3x2,5 4x230V	25m	thermal fuse	1/1	pcs
14688-35	Cable reel FILO-260 OPD 3x2,5 4x230V	30m	thermal fuse	1/1	pcs
14688-36	Cable reel FILO-260 OPD 3x2,5 4x230V	35m	thermal fuse	1/1	pcs
14688-37	Cable reel FILO-260 OPD 3x2,5 4x230V	40m	thermal fuse	1/1	pcs
14688-42	Cable reel FILO-260 OWY 3x1,5 4x230V	15m	thermal fuse	1/1	pcs
14688-43	Cable reel FILO-260 OWY 3x1,5 4x230V	20m	thermal fuse	1/1	pcs
14688-44	Cable reel FILO-260 OWY 3x1,5 4x230V	25m	thermal fuse	1/1	pcs
14688-45	Cable reel FILO-260 OWY 3x1,5 4x230V	30m	thermal fuse	1/1	pcs
14688-46	Cable reel FILO-260 OWY 3x1,5 4x230V	35m	thermal fuse	1/1	pcs
14688-47	Cable reel FILO-260 OWY 3x1,5 4x230V	40m	thermal fuse	1/1	pcs
14688-48	Cable reel FILO-260 OWY 3x1,5 4x230V	50m	thermal fuse	1/1	pcs

PLASTIC CABLE REELS TONDA-320



Type of plug: rubber

		Lenght	Equipment	Box	Unit
14708-18	Cable reel TONDA-320 OW 3x2,5 4x230V	50m	thermal fuse	1/1	pcs
14708-38	Cable reel TONDA-320 OPD 3x2,5 4x230V	50m	thermal fuse	1/1	pcs

PLASTIC CABLE REELS NERO-240



Type of plug: rubber

		Lenght	Equipment	Box	Unit
14650-2	Cable reel NERO-240 OW 3x1,5 3x230V	15m	thermal fuse / light LED	1/1	pcs
14650-3	Cable reel NERO-240 OW 3x1,5 3x230V	20m	thermal fuse / light LED	1/1	pcs
14650-4	Cable reel NERO-240 OW 3x1,5 3x230V	25m	thermal fuse / light LED	1/1	pcs
14650-5	Cable reel NERO-240 OW 3x1,5 3x230V	30m	thermal fuse / light LED	1/1	pcs
14650-6	Cable reel NERO-240 OW 3x1,5 3x230V	35m	thermal fuse / light LED	1/1	pcs
14650-7	Cable reel NERO-240 OW 3x1,5 3x230V	40m	thermal fuse / light LED	1/1	pcs
14650-12	Cable reel NERO-240 OW 3x2,5 3x230V	15m	thermal fuse / light LED	1/1	pcs
14650-13	Cable reel NERO-240 OW 3x2,5 3x230V	20m	thermal fuse / light LED	1/1	pcs
14650-14	Cable reel NERO-240 OW 3x2,5 3x230V	25m	thermal fuse / light LED	1/1	pcs
14650-15	Cable reel NERO-240 OW 3x2,5 3x230V	30m	thermal fuse / light LED	1/1	pcs
14650-22	Cable reel NERO-240 OPD 3x1,5 3x230V	15m	thermal fuse / light LED	1/1	pcs
14650-23	Cable reel NERO-240 OPD 3x1,5 3x230V	20m	thermal fuse / light LED	1/1	pcs
14650-24	Cable reel NERO-240 OPD 3x1,5 3x230V	25m	thermal fuse / light LED	1/1	pcs
14650-25	Cable reel NERO-240 OPD 3x1,5 3x230V	30m	thermal fuse / light LED	1/1	pcs
14650-26	Cable reel NERO-240 OPD 3x1,5 3x230V	35m	thermal fuse / light LED	1/1	pcs
14650-27	Cable reel NERO-240 OPD 3x1,5 3x230V	40m	thermal fuse / light LED	1/1	pcs
14650-32	Cable reel NERO-240 OPD 3x2,5 3x230V	15m	thermal fuse / light LED	1/1	pcs
14650-33	Cable reel NERO-240 OPD 3x2,5 3x230V	20m	thermal fuse / light LED	1/1	pcs
14650-34	Cable reel NERO-240 OPD 3x2,5 3x230V	25m	thermal fuse / light LED	1/1	pcs
14650-35	Cable reel NERO-240 OPD 3x2,5 3x230V	30m	thermal fuse / light LED	1/1	pcs

PLASTIC CABLE REELS NERO-290



Type of plug: rubber

		Lenght	Equipment	Box	Unit
14710-2	Cable reel NERO-290 OW 3x1,5 3x230V	15m	thermal fuse / light LED	1/1	pcs
14710-3	Cable reel NERO-290 OW 3x1,5 3x230V	20m	thermal fuse / light LED	1/1	pcs
14710-4	Cable reel NERO-290 OW 3x1,5 3x230V	25m	thermal fuse / light LED	1/1	pcs
14710-5	Cable reel NERO-290 OW 3x1,5 3x230V	30m	thermal fuse / light LED	1/1	pcs
14710-6	Cable reel NERO-290 OW 3x1,5 3x230V	35m	thermal fuse / light LED	1/1	pcs
14710-7	Cable reel NERO-290 OW 3x1,5 3x230V	40m	thermal fuse / light LED	1/1	pcs
14710-8	Cable reel NERO-290 OW 3x1,5 3x230V	50m	thermal fuse / light LED	1/1	pcs



Type of plug: rubber

		Lenght	Equipment	Box	Unit
14710-12	Cable reel NERO-290 OW 3x2,5 3x230V	15m	thermal fuse / light LED	1/1	pcs
14710-13	Cable reel NERO-290 OW 3x2,5 3x230V	20m	thermal fuse / light LED	1/1	pcs
14710-14	Cable reel NERO-290 OW 3x2,5 3x230V	25m	thermal fuse / light LED	1/1	pcs
14710-15	Cable reel NERO-290 OW 3x2,5 3x230V	30m	thermal fuse / light LED	1/1	pcs
14710-16	Cable reel NERO-290 OW 3x2,5 3x230V	35m	thermal fuse / light LED	1/1	pcs
14710-17	Cable reel NERO-290 OW 3x2,5 3x230V	40m	thermal fuse / light LED	1/1	pcs
14710-18	Cable reel NERO-290 OW 3x2,5 3x230V	50m	thermal fuse / light LED	1/1	pcs
14710-22	Cable reel NERO-290 OPD 3x1,5 3x230V	15m	thermal fuse / light LED	1/1	pcs
14710-23	Cable reel NERO-290 OPD 3x1,5 3x230V	20m	thermal fuse / light LED	1/1	pcs
14710-24	Cable reel NERO-290 OPD 3x1,5 3x230V	25m	thermal fuse / light LED	1/1	pcs
14710-25	Cable reel NERO-290 OPD 3x1,5 3x230V	30m	thermal fuse / light LED	1/1	pcs
14710-26	Cable reel NERO-290 OPD 3x1,5 3x230V	35m	thermal fuse / light LED	1/1	pcs
14710-27	Cable reel NERO-290 OPD 3x1,5 3x230V	40m	thermal fuse / light LED	1/1	pcs
14710-28	Cable reel NERO-290 OPD 3x1,5 3x230V	50m	thermal fuse / light LED	1/1	pcs
14710-32	Cable reel NERO-290 OPD 3x2,5 3x230V	15m	thermal fuse / light LED	1/1	pcs
14710-33	Cable reel NERO-290 OPD 3x2,5 3x230V	20m	thermal fuse / light LED	1/1	pcs
14710-34	Cable reel NERO-290 OPD 3x2,5 3x230V	25m	thermal fuse / light LED	1/1	pcs
14710-35	Cable reel NERO-290 OPD 3x2,5 3x230V	30m	thermal fuse / light LED	1/1	pcs
14710-36	Cable reel NERO-290 OPD 3x2,5 3x230V	35m	thermal fuse / light LED	1/1	pcs
14710-37	Cable reel NERO-290 OPD 3x2,5 3x230V	40m	thermal fuse / light LED	1/1	pcs
14710-38	Cable reel NERO-290 OPD 3x2,5 3x230V	50m	thermal fuse / light LED	1/1	pcs

METAL CABLE REELS MINI-210



Type of plug: rubber

		Lenght	Equipment	Box	Unit
14555-1	Cable reel MINI-210 OW 3x1,5 4x230V	10m	thermal fuse	1/1	pcs
14555-2	Cable reel MINI-210 OW 3x1,5 4x230V	15m	thermal fuse	1/1	pcs
14555-3	Cable reel MINI-210 OW 3x1,5 4x230V	20m	thermal fuse	1/1	pcs
14555-4	Cable reel MINI-210 OW 3x1,5 4x230V	25m	thermal fuse	1/1	pcs
14555-11	Cable reel MINI-210 OW 3x2,5 4x230V	10m	thermal fuse	1/1	pcs
14555-12	Cable reel MINI-210 OW 3x2,5 4x230V	15m	thermal fuse	1/1	pcs
14555-41	Cable reel MINI-210 OWY 3x1,5 4x230V	10m	thermal fuse	1/1	pcs
14555-42	Cable reel MINI-210 OWY 3x1,5 4x230V	15m	thermal fuse	1/1	pcs
14555-43	Cable reel MINI-210 OWY 3x1,5 4x230V	20m	thermal fuse	1/1	pcs
14555-44	Cable reel MINI-210 OWY 3x1,5 4x230V	25m	thermal fuse	1/1	pcs

METAL CABLE REELS MIDI-290



		Lenght	Equipment	Box	Unit
14569-1	Cable reel MIDI-290 OW 3x1,5 4x230V	10m	thermal fuse	1/1	pcs
14569-2	Cable reel MIDI-290 OW 3x1,5 4x230V	15m	thermal fuse	1/1	pcs
14569-3	Cable reel MIDI-290 OW 3x1,5 4x230V	20m	thermal fuse	1/1	pcs
14569-4	Cable reel MIDI-290 OW 3x1,5 4x230V	25m	thermal fuse	1/1	pcs
14569-5	Cable reel MIDI-290 OW 3x1,5 4x230V	30m	thermal fuse	1/1	pcs
14569-6	Cable reel MIDI-290 OW 3x1,5 4x230V	35m	thermal fuse	1/1	pcs
14569-7	Cable reel MIDI-290 OW 3x1,5 4x230V	40m	thermal fuse	1/1	pcs
14569-8	Cable reel MIDI-290 OW 3x1,5 4x230V	50m	thermal fuse	1/1	pcs
14569-11	Cable reel MIDI-290 OW 3x2,5 4x230V	10m	thermal fuse	1/1	pcs
14569-12	Cable reel MIDI-290 OW 3x2,5 4x230V	15m	thermal fuse	1/1	pcs
14569-13	Cable reel MIDI-290 OW 3x2,5 4x230V	20m	thermal fuse	1/1	pcs
14569-14	Cable reel MIDI-290 OW 3x2,5 4x230V	25m	thermal fuse	1/1	pcs
14569-15	Cable reel MIDI-290 OW 3x2,5 4x230V	30m	thermal fuse	1/1	pcs
14569-16	Cable reel MIDI-290 OW 3x2,5 4x230V	35m	thermal fuse	1/1	pcs
14569-17	Cable reel MIDI-290 OW 3x2,5 4x230V	40m	thermal fuse	1/1	pcs
14569-18	Cable reel MIDI-290 OW 3x2,5 4x230V	50m	thermal fuse	1/1	pcs

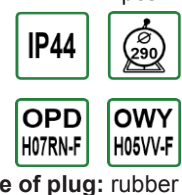
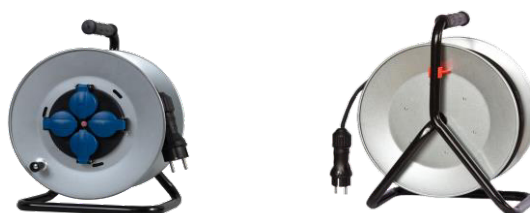

		Lenght	Equipment	Box	Unit
14569-32	Cable reel MIDI-290 OPD 3x1,5 4x230V	15m	thermal fuse	1/1	pcs
14569-33	Cable reel MIDI-290 OPD 3x1,5 4x230V	20m	thermal fuse	1/1	pcs
14569-34	Cable reel MIDI-290 OPD 3x1,5 4x230V	25m	thermal fuse	1/1	pcs
14569-35	Cable reel MIDI-290 OPD 3x1,5 4x230V	30m	thermal fuse	1/1	pcs
14569-36	Cable reel MIDI-290 OPD 3x1,5 4x230V	35m	thermal fuse	1/1	pcs
14569-37	Cable reel MIDI-290 OPD 3x1,5 4x230V	40m	thermal fuse	1/1	pcs
14569-38	Cable reel MIDI-290 OPD 3x1,5 4x230V	50m	thermal fuse	1/1	pcs
14569-42	Cable reel MIDI-290 OPD 3x2,5 4x230V	15m	thermal fuse	1/1	pcs
14569-43	Cable reel MIDI-290 OPD 3x2,5 4x230V	20m	thermal fuse	1/1	pcs
14569-44	Cable reel MIDI-290 OPD 3x2,5 4x230V	25m	thermal fuse	1/1	pcs
14569-45	Cable reel MIDI-290 OPD 3x2,5 4x230V	30m	thermal fuse	1/1	pcs
14569-46	Cable reel MIDI-290 OPD 3x2,5 4x230V	35m	thermal fuse	1/1	pcs
14569-47	Cable reel MIDI-290 OPD 3x2,5 4x230V	40m	thermal fuse	1/1	pcs
14569-48	Cable reel MIDI-290 OPD 3x2,5 4x230V	50m	thermal fuse	1/1	pcs
14569-22	Cable reel MIDI-290 OWY 3x1,5 4x230V	15m	thermal fuse	1/1	pcs
14569-23	Cable reel MIDI-290 OWY 3x1,5 4x230V	20m	thermal fuse	1/1	pcs
14569-24	Cable reel MIDI-290 OWY 3x1,5 4x230V	25m	thermal fuse	1/1	pcs
14569-25	Cable reel MIDI-290 OWY 3x1,5 4x230V	30m	thermal fuse	1/1	pcs
14569-26	Cable reel MIDI-290 OWY 3x1,5 4x230V	35m	thermal fuse	1/1	pcs
14569-27	Cable reel MIDI-290 OWY 3x1,5 4x230V	40m	thermal fuse	1/1	pcs
14569-28	Cable reel MIDI-290 OWY 3x1,5 4x230V	50m	thermal fuse	1/1	pcs

METAL CABLE REELS GRANDE-320



		Lenght	Equipment	Box	Unit
14600-2	Cable reel GRANDE-320 OW 3x1,5 4x230V	15m	thermal fuse / light LED	1/1	pcs
14600-3	Cable reel GRANDE-320 OW 3x1,5 4x230V	20m	thermal fuse / light LED	1/1	pcs
14600-4	Cable reel GRANDE-320 OW 3x1,5 4x230V	25m	thermal fuse / light LED	1/1	pcs
14600-5	Cable reel GRANDE-320 OW 3x1,5 4x230V	30m	thermal fuse / light LED	1/1	pcs
14600-6	Cable reel GRANDE-320 OW 3x1,5 4x230V	35m	thermal fuse / light LED	1/1	pcs
14600-7	Cable reel GRANDE-320 OW 3x1,5 4x230V	40m	thermal fuse / light LED	1/1	pcs
14600-8	Cable reel GRANDE-320 OW 3x1,5 4x230V	50m	thermal fuse / light LED	1/1	pcs
14600-12	Cable reel GRANDE-320 OW 3x2,5 4x230V	15m	thermal fuse / light LED	1/1	pcs
14600-13	Cable reel GRANDE-320 OW 3x2,5 4x230V	20m	thermal fuse / light LED	1/1	pcs
14600-14	Cable reel GRANDE-320 OW 3x2,5 4x230V	25m	thermal fuse / light LED	1/1	pcs
14600-15	Cable reel GRANDE-320 OW 3x2,5 4x230V	30m	thermal fuse / light LED	1/1	pcs
14600-16	Cable reel GRANDE-320 OW 3x2,5 4x230V	35m	thermal fuse / light LED	1/1	pcs
14600-17	Cable reel GRANDE-320 OW 3x2,5 4x230V	40m	thermal fuse / light LED	1/1	pcs
14600-18	Cable reel GRANDE-320 OW 3x2,5 4x230V	50m	thermal fuse / light LED	1/1	pcs



		Lenght	Equipment	Box	Unit
14600-22	Cable reel GRANDE-320 OPD 3x1,5 4x230V	15m	thermal fuse / light LED	1/1	pcs
14600-23	Cable reel GRANDE-320 OPD 3x1,5 4x230V	20m	thermal fuse / light LED	1/1	pcs
14600-24	Cable reel GRANDE-320 OPD 3x1,5 4x230V	25m	thermal fuse / light LED	1/1	pcs
14600-25	Cable reel GRANDE-320 OPD 3x1,5 4x230V	30m	thermal fuse / light LED	1/1	pcs
14600-26	Cable reel GRANDE-320 OPD 3x1,5 4x230V	35m	thermal fuse / light LED	1/1	pcs
14600-27	Cable reel GRANDE-320 OPD 3x1,5 4x230V	40m	thermal fuse / light LED	1/1	pcs
14600-28	Cable reel GRANDE-320 OPD 3x1,5 4x230V	50m	thermal fuse / light LED	1/1	pcs
14600-32	Cable reel GRANDE-320 OPD 3x2,5 4x230V	15m	thermal fuse / light LED	1/1	pcs
14600-33	Cable reel GRANDE-320 OPD 3x2,5 4x230V	20m	thermal fuse / light LED	1/1	pcs
14600-34	Cable reel GRANDE-320 OPD 3x2,5 4x230V	25m	thermal fuse / light LED	1/1	pcs
14600-35	Cable reel GRANDE-320 OPD 3x2,5 4x230V	30m	thermal fuse / light LED	1/1	pcs
14600-36	Cable reel GRANDE-320 OPD 3x2,5 4x230V	35m	thermal fuse / light LED	1/1	pcs
14600-37	Cable reel GRANDE-320 OPD 3x2,5 4x230V	40m	thermal fuse / light LED	1/1	pcs
14600-38	Cable reel GRANDE-320 OPD 3x2,5 4x230V	50m	thermal fuse / light LED	1/1	pcs

METAL CABLE REELS BORDO-320



		Lenght	Equipment	Box	Unit
14390-3	Cable reel BORDO-320 OW 3x1,5 4x230V	20m	thermal fuse	1/1	pcs
14390-4	Cable reel BORDO-320 OW 3x1,5 4x230V	25m	thermal fuse	1/1	pcs
14390-5	Cable reel BORDO-320 OW 3x1,5 4x230V	30m	thermal fuse	1/1	pcs
14390-6	Cable reel BORDO-320 OW 3x1,5 4x230V	35m	thermal fuse	1/1	pcs
14390-7	Cable reel BORDO-320 OW 3x1,5 4x230V	40m	thermal fuse	1/1	pcs
14390-8	Cable reel BORDO-320 OW 3x1,5 4x230V	50m	thermal fuse	1/1	pcs
14390-13	Cable reel BORDO-320 OW 3x2,5 4x230V	20m	thermal fuse	1/1	pcs
14390-14	Cable reel BORDO-320 OW 3x2,5 4x230V	25m	thermal fuse	1/1	pcs
14390-15	Cable reel BORDO-320 OW 3x2,5 4x230V	30m	thermal fuse	1/1	pcs
14390-16	Cable reel BORDO-320 OW 3x2,5 4x230V	35m	thermal fuse	1/1	pcs
14390-17	Cable reel BORDO-320 OW 3x2,5 4x230V	40m	thermal fuse	1/1	pcs
14390-18	Cable reel BORDO-320 OW 3x2,5 4x230V	50m	thermal fuse	1/1	pcs



		Lenght	Equipment	Box	Unit
14390-23	Cable reel BORDO-320 OPD 3x1,5 4x230V	20m	thermal fuse	1/1	pcs
14390-24	Cable reel BORDO-320 OPD 3x1,5 4x230V	25m	thermal fuse	1/1	pcs
14390-25	Cable reel BORDO-320 OPD 3x1,5 4x230V	30m	thermal fuse	1/1	pcs
14390-26	Cable reel BORDO-320 OPD 3x1,5 4x230V	35m	thermal fuse	1/1	pcs
14390-27	Cable reel BORDO-320 OPD 3x1,5 4x230V	40m	thermal fuse	1/1	pcs
14390-28	Cable reel BORDO-320 OPD 3x1,5 4x230V	50m	thermal fuse	1/1	pcs
14390-33	Cable reel BORDO-320 OPD 3x2,5 4x230V	20m	thermal fuse	1/1	pcs
14390-34	Cable reel BORDO-320 OPD 3x2,5 4x230V	25m	thermal fuse	1/1	pcs
14390-35	Cable reel BORDO-320 OPD 3x2,5 4x230V	30m	thermal fuse	1/1	pcs
14390-36	Cable reel BORDO-320 OPD 3x2,5 4x230V	35m	thermal fuse	1/1	pcs
14390-37	Cable reel BORDO-320 OPD 3x2,5 4x230V	40m	thermal fuse	1/1	pcs
14390-38	Cable reel BORDO-320 OPD 3x2,5 4x230V	50m	thermal fuse	1/1	pcs

METAL CABLE REELS BORDO-320

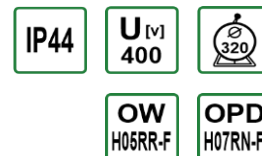

		Lenght	Plug	Box	Unit
14300-170	Cable reel BORDO-320 OW 5x1,5 16A 5p, 230V	20m	16A 5p	1/1	pcs
14300-171	Cable reel BORDO-320 OW 5x1,5 16A 5p, 230V	25m	16A 5p	1/1	pcs
14300-172	Cable reel BORDO-320 OW 5x1,5 16A 5p, 230V	30m	16A 5p	1/1	pcs
14300-173	Cable reel BORDO-320 OW 5x1,5 16A 5p, 230V	35m	16A 5p	1/1	pcs
14300-174	Cable reel BORDO-320 OW 5x2,5 16A 5p, 230V	20m	16A 5p	1/1	pcs
14300-175	Cable reel BORDO-320 OW 5x2,5 16A 5p, 230V	25m	16A 5p	1/1	pcs
14300-176	Cable reel BORDO-320 OW 5x2,5 16A 5p, 230V	30m	16A 5p	1/1	pcs
14300-177	Cable reel BORDO-320 OW 5x2,5 16A 5p, 230V	35m	16A 5p	1/1	pcs
14300-178	Cable reel BORDO-320 OPD 5x2,5 16A 5p, 230V	20m	16A 5p	1/1	pcs
14300-179	Cable reel BORDO-320 OPD 5x2,5 16A 5p, 230V	25m	16A 5p	1/1	pcs
14300-180	Cable reel BORDO-320 OPD 5x2,5 16A 5p, 230V	30m	16A 5p	1/1	pcs
14300-181	Cable reel BORDO-320 OPD 5x2,5 16A 5p, 230V	35m	16A 5p	1/1	pcs
14300-182	Cable reel BORDO-320 OPD 5x4 32A 5p, 230V	15m	32A 5p	1/1	pcs
14300-183	Cable reel BORDO-320 OPD 5x4 32A 5p, 230V	20m	32A 5p	1/1	pcs
14300-184	Cable reel BORDO-320 OPD 5x4 32A 5p, 230V	25m	32A 5p	1/1	pcs

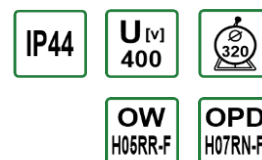

		Lenght	Plug	Box	Unit
14300-39	Cable reel BORDO-320 OW 5x1,5 16A 5p, 2x230V	20m	16A 5p	1/1	pcs
14300-40	Cable reel BORDO-320 OW 5x1,5 16A 5p, 2x230V	25m	16A 5p	1/1	pcs
14300-41	Cable reel BORDO-320 OW 5x1,5 16A 5p, 2x230V	30m	16A 5p	1/1	pcs
14300-42	Cable reel BORDO-320 OW 5x1,5 16A 5p, 2x230V	35m	16A 5p	1/1	pcs
14300-8	Cable reel BORDO-320 OW 5x2,5 16A 5p, 2x230V	20m	16A 5p	1/1	pcs
14300-9	Cable reel BORDO-320 OW 5x2,5 16A 5p, 2x230V	25m	16A 5p	1/1	pcs
14300-10	Cable reel BORDO-320 OW 5x2,5 16A 5p, 2x230V	30m	16A 5p	1/1	pcs
14300-11	Cable reel BORDO-320 OW 5x2,5 16A 5p, 2x230V	35m	16A 5p	1/1	pcs
14300-185	Cable reel BORDO-320 OPD 5x2,5 16A 5p, 2x230V	20m	16A 5p	1/1	pcs
14300-186	Cable reel BORDO-320 OPD 5x2,5 16A 5p, 2x230V	25m	16A 5p	1/1	pcs
14300-187	Cable reel BORDO-320 OPD 5x2,5 16A 5p, 2x230V	30m	16A 5p	1/1	pcs
14300-188	Cable reel BORDO-320 OPD 5x2,5 16A 5p, 2x230V	35m	16A 5p	1/1	pcs
14300-118	Cable reel BORDO-320 OPD 5x4 32A 5p, 2x230V	15m	32A 5p	1/1	pcs
14300-119	Cable reel BORDO-320 OPD 5x4 32A 5p, 2x230V	20m	32A 5p	1/1	pcs
14300-66	Cable reel BORDO-320 OPD 5x4 32A 5p, 2x230V	25m	32A 5p	1/1	pcs

METAL CABLE REELS BORDO-320

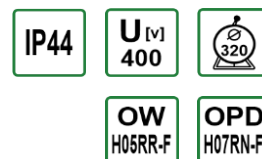

		Lenght	Plug	Box	Unit
14300-43	Cable reel BORDO-320 OW 5x1,5 2x16A 5p	20m	16A 5p	1/1	pcs
14300-44	Cable reel BORDO-320 OW 5x1,5 2x16A 5p	25m	16A 5p	1/1	pcs
14300-45	Cable reel BORDO-320 OW 5x1,5 2x16A 5p	30m	16A 5p	1/1	pcs
14300-46	Cable reel BORDO-320 OW 5x1,5 2x16A 5p	35m	16A 5p	1/1	pcs
14300-12	Cable reel BORDO-320 OW 5x2,5 2x16A 5p	20m	16A 5p	1/1	pcs
14300-13	Cable reel BORDO-320 OW 5x2,5 2x16A 5p	25m	16A 5p	1/1	pcs
14300-14	Cable reel BORDO-320 OW 5x2,5 2x16A 5p	30m	16A 5p	1/1	pcs
14300-15	Cable reel BORDO-320 OW 5x2,5 2x16A 5p	35m	16A 5p	1/1	pcs
14300-189	Cable reel BORDO-320 OPD 5x2,5 2x16A 5p	20m	16A 5p	1/1	pcs
14300-190	Cable reel BORDO-320 OPD 5x2,5 2x16A 5p	25m	16A 5p	1/1	pcs
14300-191	Cable reel BORDO-320 OPD 5x2,5 2x16A 5p	30m	16A 5p	1/1	pcs
14300-192	Cable reel BORDO-320 OPD 5x2,5 2x16A 5p	35m	16A 5p	1/1	pcs
14300-120	Cable reel BORDO-320 OPD 5x4 2x32A 5p	15m	32A 5p	1/1	pcs
14300-50	Cable reel BORDO-320 OPD 5x4 2x32A 5p	20m	32A 5p	1/1	pcs
14300-59	Cable reel BORDO-320 OPD 5x4 2x32A 5p	25m	32A 5p	1/1	pcs

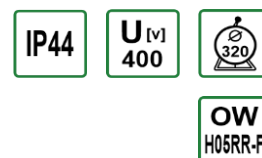

		Lenght	Plug	Box	Unit
14300-193	Cable reel BORDO-320 OW 5x1,5 2x16A 5p, 230V	20m	16A 5p	1/1	pcs
14300-149	Cable reel BORDO-320 OW 5x1,5 2x16A 5p, 230V	25m	16A 5p	1/1	pcs
14300-194	Cable reel BORDO-320 OW 5x1,5 2x16A 5p, 230V	30m	16A 5p	1/1	pcs
14300-195	Cable reel BORDO-320 OW 5x1,5 2x16A 5p, 230V	35m	16A 5p	1/1	pcs
14300-16	Cable reel BORDO-320 OW 5x2,5 2x16A 5p, 230V	20m	16A 5p	1/1	pcs
14300-17	Cable reel BORDO-320 OW 5x2,5 2x16A 5p, 230V	25m	16A 5p	1/1	pcs
14300-18	Cable reel BORDO-320 OW 5x2,5 2x16A 5p, 230V	30m	16A 5p	1/1	pcs
14300-19	Cable reel BORDO-320 OW 5x2,5 2x16A 5p, 230V	35m	16A 5p	1/1	pcs
14300-73	Cable reel BORDO-320 OW 5x2,5 16A 5p, 32A 5p, 230V	20m	16A 5p	1/1	pcs
14300-55	Cable reel BORDO-320 OW 5x2,5 16A 5p, 32A 5p, 230V	25m	16A 5p	1/1	pcs
14300-56	Cable reel BORDO-320 OW 5x2,5 16A 5p, 32A 5p, 230V	30m	16A 5p	1/1	pcs
14300-57	Cable reel BORDO-320 OW 5x2,5 16A 5p, 32A 5p, 230V	35m	16A 5p	1/1	pcs

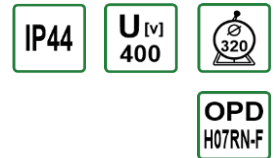

		Lenght	Plug	Box	Unit
14300-196	Cable reel BORDO-320 OPD 5x2,5 2x16A 5p, 230V	20m	16A 5p	1/1	pcs
14300-197	Cable reel BORDO-320 OPD 5x2,5 2x16A 5p, 230V	25m	16A 5p	1/1	pcs
14300-198	Cable reel BORDO-320 OPD 5x2,5 2x16A 5p, 230V	30m	16A 5p	1/1	pcs
14300-199	Cable reel BORDO-320 OPD 5x2,5 2x16A 5p, 230V	35m	16A 5p	1/1	pcs
14300-200	Cable reel BORDO-320 OPD 5x2,5 16A 5p, 32A 5p, 230V	20m	16A 5p	1/1	pcs
14300-201	Cable reel BORDO-320 OPD 5x2,5 16A 5p, 32A 5p, 230V	25m	16A 5p	1/1	pcs
14300-202	Cable reel BORDO-320 OPD 5x2,5 16A 5p, 32A 5p, 230V	30m	16A 5p	1/1	pcs
14300-203	Cable reel BORDO-320 OPD 5x2,5 16A 5p, 32A 5p, 230V	35m	16A 5p	1/1	pcs
14300-36	Cable reel BORDO-320 OPD 5x4 2x32A 5p, 230V	15m	32A 5p	1/1	pcs
14300-37	Cable reel BORDO-320 OPD 5x4 2x32A 5p, 230V	20m	32A 5p	1/1	pcs
14300-38	Cable reel BORDO-320 OPD 5x4 2x32A 5p, 230V	25m	32A 5p	1/1	pcs

METAL CABLE REELS GRANDE-320

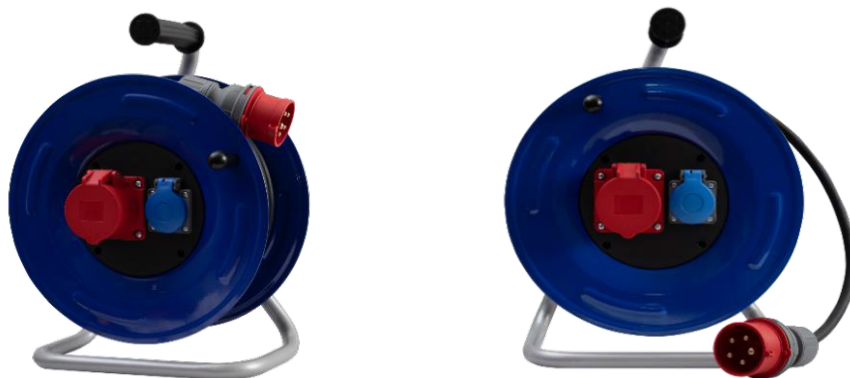

		Lenght	Plug	Box	Unit
14600-39	Cable reel GRANDE-320 OW 5x1,5 16A 5p, 230V	15m	16A 5p	1/1	pcs
14600-40	Cable reel GRANDE-320 OW 5x1,5 16A 5p, 230V	20m	16A 5p	1/1	pcs
14600-41	Cable reel GRANDE-320 OW 5x1,5 16A 5p, 230V	25m	16A 5p	1/1	pcs
14600-42	Cable reel GRANDE-320 OW 5x1,5 16A 5p, 230V	30m	16A 5p	1/1	pcs
14600-43	Cable reel GRANDE-320 OW 5x1,5 16A 5p, 230V	35m	16A 5p	1/1	pcs
14600-44	Cable reel GRANDE-320 OW 5x2,5 16A 5p, 230V	15m	16A 5p	1/1	pcs
14600-45	Cable reel GRANDE-320 OW 5x2,5 16A 5p, 230V	20m	16A 5p	1/1	pcs
14600-46	Cable reel GRANDE-320 OW 5x2,5 16A 5p, 230V	25m	16A 5p	1/1	pcs
14600-47	Cable reel GRANDE-320 OW 5x2,5 16A 5p, 230V	30m	16A 5p	1/1	pcs
14600-48	Cable reel GRANDE-320 OPD 5x2,5 16A 5p, 230V	15m	16A 5p	1/1	pcs
14600-49	Cable reel GRANDE-320 OPD 5x2,5 16A 5p, 230V	20m	16A 5p	1/1	pcs
14600-50	Cable reel GRANDE-320 OPD 5x2,5 16A 5p, 230V	25m	16A 5p	1/1	pcs
14600-51	Cable reel GRANDE-320 OPD 5x2,5 16A 5p, 230V	30m	16A 5p	1/1	pcs

METAL CABLE REELS MAKARA-370

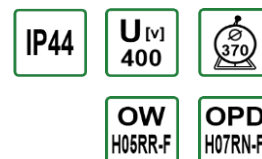

		Lenght	Plug	Box	Unit
14700-33	Cable reel MAKARA-370 OW 5x2,5 2x16A 5p	30m	16A 5p	1/1	pcs
14700-34	Cable reel MAKARA-370 OW 5x2,5 2x16A 5p	35m	16A 5p	1/1	pcs
14700-35	Cable reel MAKARA-370 OW 5x2,5 2x16A 5p	40m	16A 5p	1/1	pcs
14700-36	Cable reel MAKARA-370 OW 5x2,5 2x16A 5p	50m	16A 5p	1/1	pcs
14700-37	Cable reel MAKARA-370 OW 5x2,5 16A 5p, 32A 5p	30m	16A 5p	1/1	pcs
14700-38	Cable reel MAKARA-370 OW 5x2,5 16A 5p, 32A 5p	35m	16A 5p	1/1	pcs
14700-39	Cable reel MAKARA-370 OW 5x2,5 16A 5p, 32A 5p	40m	16A 5p	1/1	pcs
14700-40	Cable reel MAKARA-370 OW 5x2,5 16A 5p, 32A 5p	50m	16A 5p	1/1	pcs
14700-41	Cable reel MAKARA-370 OPD 5x4 2x32A 5p	20m	32A 5p	1/1	pcs
14700-42	Cable reel MAKARA-370 OPD 5x4 2x32A 5p	25m	32A 5p	1/1	pcs
14700-43	Cable reel MAKARA-370 OPD 5x4 2x32A 5p	30m	32A 5p	1/1	pcs
14700-44	Cable reel MAKARA-370 OPD 5x4 2x32A 5p	35m	32A 5p	1/1	pcs
14700-45	Cable reel MAKARA-370 OPD 5x6 2x32A 5p	10m	32A 5p	1/1	pcs
14700-46	Cable reel MAKARA-370 OPD 5x6 2x32A 5p	15m	32A 5p	1/1	pcs
14700-47	Cable reel MAKARA-370 OPD 5x6 2x32A 5p	20m	32A 5p	1/1	pcs

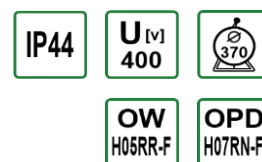

		Lenght	Plug	Box	Unit
14700-63	Cable reel MAKARA-370 OW 5x2,5 2x16A 5p, 230V	30m	16A 5p	1/1	pcs
14700-64	Cable reel MAKARA-370 OW 5x2,5 2x16A 5p, 230V	35m	16A 5p	1/1	pcs
14700-65	Cable reel MAKARA-370 OW 5x2,5 2x16A 5p, 230V	40m	16A 5p	1/1	pcs
14700-66	Cable reel MAKARA-370 OW 5x2,5 2x16A 5p, 230V	50m	16A 5p	1/1	pcs
14700-67	Cable reel MAKARA-370 OW 5x2,5 16A 5p, 32A 5p, 230V	30m	16A 5p	1/1	pcs
14700-68	Cable reel MAKARA-370 OW 5x2,5 16A 5p, 32A 5p, 230V	35m	16A 5p	1/1	pcs
14700-69	Cable reel MAKARA-370 OW 5x2,5 16A 5p, 32A 5p, 230V	40m	16A 5p	1/1	pcs
14700-70	Cable reel MAKARA-370 OW 5x2,5 16A 5p, 32A 5p, 230V	50m	16A 5p	1/1	pcs
14700-71	Cable reel MAKARA-370 OPD 5x4 2x32A 5p, 230V	20m	32A 5p	1/1	pcs
14700-72	Cable reel MAKARA-370 OPD 5x4 2x32A 5p, 230V	25m	32A 5p	1/1	pcs
14700-73	Cable reel MAKARA-370 OPD 5x4 2x32A 5p, 230V	30m	32A 5p	1/1	pcs
14700-74	Cable reel MAKARA-370 OPD 5x4 2x32A 5p, 230V	35m	32A 5p	1/1	pcs
14700-75	Cable reel MAKARA-370 OPD 5x6 2x32A 5p, 230V	10m	32A 5p	1/1	pcs
14700-76	Cable reel MAKARA-370 OPD 5x6 2x32A 5p, 230V	15m	32A 5p	1/1	pcs
14700-77	Cable reel MAKARA-370 OPD 5x6 2x32A 5p, 230V	20m	32A 5p	1/1	pcs

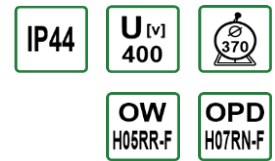

		Lenght	Plug	Box	Unit
14700-48	Cable reel MAKARA-370 OW 5x2,5 2x16A 5p, 2x230V	30m	16A 5p	1/1	pcs
14700-49	Cable reel MAKARA-370 OW 5x2,5 2x16A 5p, 2x230V	35m	16A 5p	1/1	pcs
14700-50	Cable reel MAKARA-370 OW 5x2,5 2x16A 5p, 2x230V	40m	16A 5p	1/1	pcs
14700-51	Cable reel MAKARA-370 OW 5x2,5 2x16A 5p, 2x230V	50m	16A 5p	1/1	pcs
14700-52	Cable reel MAKARA-370 OW 5x2,5 16A 5p, 32A 5p, 2x230V	30m	16A 5p	1/1	pcs
14700-53	Cable reel MAKARA-370 OW 5x2,5 16A 5p, 32A 5p, 2x230V	35m	16A 5p	1/1	pcs
14700-54	Cable reel MAKARA-370 OW 5x2,5 16A 5p, 32A 5p, 2x230V	40m	16A 5p	1/1	pcs
14700-55	Cable reel MAKARA-370 OW 5x2,5 16A 5p, 32A 5p, 2x230V	50m	16A 5p	1/1	pcs
14700-56	Cable reel MAKARA-370 OPD 5x4 2x32A 5p, 2x230V	20m	32A 5p	1/1	pcs
14700-57	Cable reel MAKARA-370 OPD 5x4 2x32A 5p, 2x230V	25m	32A 5p	1/1	pcs
14700-58	Cable reel MAKARA-370 OPD 5x4 2x32A 5p, 2x230V	30m	32A 5p	1/1	pcs
14700-59	Cable reel MAKARA-370 OPD 5x4 2x32A 5p, 2x230V	35m	32A 5p	1/1	pcs
14700-60	Cable reel MAKARA-370 OPD 5x6 2x32A 5p, 2x230V	10m	32A 5p	1/1	pcs
14700-61	Cable reel MAKARA-370 OPD 5x6 2x32A 5p, 2x230V	15m	32A 5p	1/1	pcs
14700-62	Cable reel MAKARA-370 OPD 5x6 2x32A 5p, 2x230V	20m	32A 5p	1/1	pcs



		Lenght	Plug	Box	Unit
14700-86	Cable reel MAKARA-370 OW 5x2,5 16A 5p, 3x230V	30m	16A 5p	1/1	pcs
14700-87	Cable reel MAKARA-370 OW 5x2,5 16A 5p, 3x230V	35m	16A 5p	1/1	pcs
14700-88	Cable reel MAKARA-370 OW 5x2,5 16A 5p, 3x230V	40m	16A 5p	1/1	pcs
14700-89	Cable reel MAKARA-370 OW 5x2,5 16A 5p, 3x230V	50m	16A 5p	1/1	pcs
14700-90	Cable reel MAKARA-370 OPD 5x4 32A 5p, 3x230V	20m	32A 5p	1/1	pcs
14700-91	Cable reel MAKARA-370 OPD 5x4 32A 5p, 3x230V	25m	32A 5p	1/1	pcs
14700-92	Cable reel MAKARA-370 OPD 5x4 32A 5p, 3x230V	30m	32A 5p	1/1	pcs
14700-93	Cable reel MAKARA-370 OPD 5x4 32A 5p, 3x230V	35m	32A 5p	1/1	pcs
14700-94	Cable reel MAKARA-370 OPD 5x6 32A 5p, 3x230V	10m	32A 5p	1/1	pcs
14700-95	Cable reel MAKARA-370 OPD 5x6 32A 5p, 3x230V	15m	32A 5p	1/1	pcs
14700-96	Cable reel MAKARA-370 OPD 5x6 32A 5p, 3x230V	20m	32A 5p	1/1	pcs

METAL CABLE REELS MAKARA-460

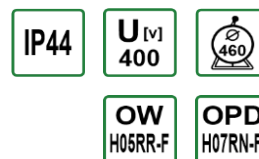

		Lenght	Plug	Box	Unit
14800-20	Cable reel MAKARA-460 OW 5x2,5 2x16A 5p	30m	16A 5p	1/1	pcs
14800-21	Cable reel MAKARA-460 OW 5x2,5 2x16A 5p	35m	16A 5p	1/1	pcs
14800-22	Cable reel MAKARA-460 OW 5x2,5 2x16A 5p	40m	16A 5p	1/1	pcs
14800-23	Cable reel MAKARA-460 OW 5x2,5 2x16A 5p	50m	16A 5p	1/1	pcs
14800-24	Cable reel MAKARA-460 OW 5x2,5 16A 5p, 32A 5p	30m	16A 5p	1/1	pcs
14800-25	Cable reel MAKARA-460 OW 5x2,5 16A 5p, 32A 5p	35m	16A 5p	1/1	pcs
14800-26	Cable reel MAKARA-460 OW 5x2,5 16A 5p, 32A 5p	40m	16A 5p	1/1	pcs
14800-27	Cable reel MAKARA-460 OW 5x2,5 16A 5p, 32A 5p	50m	16A 5p	1/1	pcs
14800-28	Cable reel MAKARA-460 OPD 5x4 2x32A 5p	30m	32A 5p	1/1	pcs
14800-29	Cable reel MAKARA-460 OPD 5x4 2x32A 5p	35m	32A 5p	1/1	pcs
14800-30	Cable reel MAKARA-460 OPD 5x4 2x32A 5p	40m	32A 5p	1/1	pcs
14800-31	Cable reel MAKARA-460 OPD 5x4 2x32A 5p	50m	32A 5p	1/1	pcs
14800-32	Cable reel MAKARA-460 OPD 5x6 2x32A 5p	20m	32A 5p	1/1	pcs
14800-33	Cable reel MAKARA-460 OPD 5x6 2x32A 5p	25m	32A 5p	1/1	pcs
14800-34	Cable reel MAKARA-460 OPD 5x6 2x32A 5p	30m	32A 5p	1/1	pcs
14800-35	Cable reel MAKARA-460 OPD 5x6 2x32A 5p	35m	32A 5p	1/1	pcs
14800-36	Cable reel MAKARA-460 OPD 5x6 2x32A 5p	40m	32A 5p	1/1	pcs

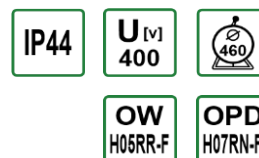

		Lenght	Plug	Box	Unit
14800-54	Cable reel MAKARA-460 OW 5x2,5 2x16A 5p, 230V	30m	16A 5p	1/1	pcs
14800-55	Cable reel MAKARA-460 OW 5x2,5 2x16A 5p, 230V	35m	16A 5p	1/1	pcs
14800-56	Cable reel MAKARA-460 OW 5x2,5 2x16A 5p, 230V	40m	16A 5p	1/1	pcs
14800-57	Cable reel MAKARA-460 OW 5x2,5 2x16A 5p, 230V	50m	16A 5p	1/1	pcs
14800-58	Cable reel MAKARA-460 OW 5x2,5 16A 5p, 32A 5p, 230V	30m	16A 5p	1/1	pcs
14800-59	Cable reel MAKARA-460 OW 5x2,5 16A 5p, 32A 5p, 230V	35m	16A 5p	1/1	pcs
14800-60	Cable reel MAKARA-460 OW 5x2,5 16A 5p, 32A 5p, 230V	40m	16A 5p	1/1	pcs
14800-61	Cable reel MAKARA-460 OW 5x2,5 16A 5p, 32A 5p, 230V	50m	16A 5p	1/1	pcs
14800-62	Cable reel MAKARA-460 OPD 5x4 2x32A 5p, 230V	30m	32A 5p	1/1	pcs
14800-63	Cable reel MAKARA-460 OPD 5x4 2x32A 5p, 230V	35m	32A 5p	1/1	pcs
14800-64	Cable reel MAKARA-460 OPD 5x4 2x32A 5p, 230V	40m	32A 5p	1/1	pcs
14800-65	Cable reel MAKARA-460 OPD 5x4 2x32A 5p, 230V	50m	32A 5p	1/1	pcs
14800-66	Cable reel MAKARA-460 OPD 5x6 2x32A 5p, 230V	20m	32A 5p	1/1	pcs
14800-67	Cable reel MAKARA-460 OPD 5x6 2x32A 5p, 230V	25m	32A 5p	1/1	pcs
14800-68	Cable reel MAKARA-460 OPD 5x6 2x32A 5p, 230V	30m	32A 5p	1/1	pcs
14800-69	Cable reel MAKARA-460 OPD 5x6 2x32A 5p, 230V	35m	32A 5p	1/1	pcs
14800-70	Cable reel MAKARA-460 OPD 5x6 2x32A 5p, 230V	40m	32A 5p	1/1	pcs

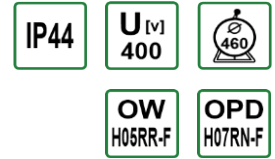

		Lenght	Plug	Box	Unit
14800-37	Cable reel MAKARA-460 OW 5x2,5 2x16A 5p, 2x230V	30m	16A 5p	1/1	pcs
14800-38	Cable reel MAKARA-460 OW 5x2,5 2x16A 5p, 2x230V	35m	16A 5p	1/1	pcs
14800-39	Cable reel MAKARA-460 OW 5x2,5 2x16A 5p, 2x230V	40m	16A 5p	1/1	pcs
14800-40	Cable reel MAKARA-460 OW 5x2,5 2x16A 5p, 2x230V	50m	16A 5p	1/1	pcs
14800-41	Cable reel MAKARA-460 OW 5x2,5 16A 5p, 32A 5p, 2x230V	30m	16A 5p	1/1	pcs
14800-42	Cable reel MAKARA-460 OW 5x2,5 16A 5p, 32A 5p, 2x230V	35m	16A 5p	1/1	pcs
14800-43	Cable reel MAKARA-460 OW 5x2,5 16A 5p, 32A 5p, 2x230V	40m	16A 5p	1/1	pcs
14800-44	Cable reel MAKARA-460 OW 5x2,5 16A 5p, 32A 5p, 2x230V	50m	16A 5p	1/1	pcs
14800-45	Cable reel MAKARA-460 OPD 5x4 2x32A 5p, 2x230V	30m	32A 5p	1/1	pcs
14800-46	Cable reel MAKARA-460 OPD 5x4 2x32A 5p, 2x230V	35m	32A 5p	1/1	pcs
14800-47	Cable reel MAKARA-460 OPD 5x4 2x32A 5p, 2x230V	40m	32A 5p	1/1	pcs
14800-48	Cable reel MAKARA-460 OPD 5x4 2x32A 5p, 2x230V	50m	32A 5p	1/1	pcs
14800-49	Cable reel MAKARA-460 OPD 5x6 2x32A 5p, 2x230V	20m	32A 5p	1/1	pcs
14800-50	Cable reel MAKARA-460 OPD 5x6 2x32A 5p, 2x230V	25m	32A 5p	1/1	pcs
14800-51	Cable reel MAKARA-460 OPD 5x6 2x32A 5p, 2x230V	30m	32A 5p	1/1	pcs
14800-52	Cable reel MAKARA-460 OPD 5x6 2x32A 5p, 2x230V	35m	32A 5p	1/1	pcs
14800-53	Cable reel MAKARA-460 OPD 5x6 2x32A 5p, 2x230V	40m	32A 5p	1/1	pcs



		Lenght	Plug	Box	Unit
14800-79	Cable reel MAKARA-460 OW 5x2,5 16A 5p, 3x230V	30m	16A 5p	1/1	pcs
14800-80	Cable reel MAKARA-460 OW 5x2,5 16A 5p, 3x230V	35m	16A 5p	1/1	pcs
14800-81	Cable reel MAKARA-460 OW 5x2,5 16A 5p, 3x230V	40m	16A 5p	1/1	pcs
14800-82	Cable reel MAKARA-460 OW 5x2,5 16A 5p, 3x230V	50m	16A 5p	1/1	pcs
14800-83	Cable reel MAKARA-460 OPD 5x4 32A 5p, 3x230V	30m	32A 5p	1/1	pcs
14800-84	Cable reel MAKARA-460 OPD 5x4 32A 5p, 3x230V	35m	32A 5p	1/1	pcs
14800-85	Cable reel MAKARA-460 OPD 5x4 32A 5p, 3x230V	40m	32A 5p	1/1	pcs
14800-86	Cable reel MAKARA-460 OPD 5x4 32A 5p, 3x230V	50m	32A 5p	1/1	pcs
14800-87	Cable reel MAKARA-460 OPD 5x6 32A 5p, 3x230V	20m	32A 5p	1/1	pcs
14800-88	Cable reel MAKARA-460 OPD 5x6 32A 5p, 3x230V	25m	32A 5p	1/1	pcs
14800-89	Cable reel MAKARA-460 OPD 5x6 32A 5p, 3x230V	30m	32A 5p	1/1	pcs
14800-90	Cable reel MAKARA-460 OPD 5x6 32A 5p, 3x230V	35m	32A 5p	1/1	pcs
14800-91	Cable reel MAKARA-460 OPD 5x6 32A 5p, 3x230V	40m	32A 5p	1/1	pcs

METAL CABLE REELS MAKARA-460 NK

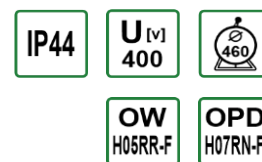

			Lenght	Plug	Box	Unit
15000-21	Cable reel MAKARA-460 NK OW 5x2,5 2x16A 5p		30m	16A 5p	1/1	pcs
15000-22	Cable reel MAKARA-460 NK OW 5x2,5 2x16A 5p		35m	16A 5p	1/1	pcs
15000-23	Cable reel MAKARA-460 NK OW 5x2,5 2x16A 5p		40m	16A 5p	1/1	pcs
15000-24	Cable reel MAKARA-460 NK OW 5x2,5 2x16A 5p		50m	16A 5p	1/1	pcs
15000-25	Cable reel MAKARA-460 NK OW 5x2,5 16A 5p, 32A 5p		30m	16A 5p	1/1	pcs
15000-26	Cable reel MAKARA-460 NK OW 5x2,5 16A 5p, 32A 5p		35m	16A 5p	1/1	pcs
15000-27	Cable reel MAKARA-460 NK OW 5x2,5 16A 5p, 32A 5p		40m	16A 5p	1/1	pcs
15000-28	Cable reel MAKARA-460 NK OW 5x2,5 16A 5p, 32A 5p		50m	16A 5p	1/1	pcs
15000-29	Cable reel MAKARA-460 NK OPD 5x4 2x32A 5p		30m	32A 5p	1/1	pcs
15000-30	Cable reel MAKARA-460 NK OPD 5x4 2x32A 5p		35m	32A 5p	1/1	pcs
15000-31	Cable reel MAKARA-460 NK OPD 5x4 2x32A 5p		40m	32A 5p	1/1	pcs
15000-32	Cable reel MAKARA-460 NK OPD 5x4 2x32A 5p		50m	32A 5p	1/1	pcs
15000-33	Cable reel MAKARA-460 NK OPD 5x6 2x32A 5p		20m	32A 5p	1/1	pcs
15000-34	Cable reel MAKARA-460 NK OPD 5x6 2x32A 5p		25m	32A 5p	1/1	pcs
15000-35	Cable reel MAKARA-460 NK OPD 5x6 2x32A 5p		30m	32A 5p	1/1	pcs
15000-36	Cable reel MAKARA-460 NK OPD 5x6 2x32A 5p		35m	32A 5p	1/1	pcs
15000-37	Cable reel MAKARA-460 NK OPD 5x6 2x32A 5p		40m	32A 5p	1/1	pcs

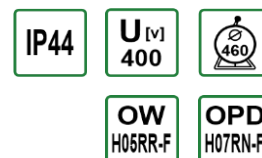

			Lenght	Plug	Box	Unit
15000-55	Cable reel MAKARA-460 NK OW 5x2,5 2x16A 5p, 230V		30m	16A 5p	1/1	pcs
15000-56	Cable reel MAKARA-460 NK OW 5x2,5 2x16A 5p, 230V		35m	16A 5p	1/1	pcs
15000-57	Cable reel MAKARA-460 NK OW 5x2,5 2x16A 5p, 230V		40m	16A 5p	1/1	pcs
15000-58	Cable reel MAKARA-460 NK OW 5x2,5 2x16A 5p, 230V		50m	16A 5p	1/1	pcs
15000-59	Cable reel MAKARA-460 NK OW 5x2,5 16A 5p, 32A 5p, 230V		30m	16A 5p	1/1	pcs
15000-60	Cable reel MAKARA-460 NK OW 5x2,5 16A 5p, 32A 5p, 230V		35m	16A 5p	1/1	pcs
15000-61	Cable reel MAKARA-460 NK OW 5x2,5 16A 5p, 32A 5p, 230V		40m	16A 5p	1/1	pcs
15000-62	Cable reel MAKARA-460 NK OW 5x2,5 16A 5p, 32A 5p, 230V		50m	16A 5p	1/1	pcs
15000-63	Cable reel MAKARA-460 NK OPD 5x4 2x32A 5p, 230V		30m	32A 5p	1/1	pcs
15000-64	Cable reel MAKARA-460 NK OPD 5x4 2x32A 5p, 230V		35m	32A 5p	1/1	pcs
15000-65	Cable reel MAKARA-460 NK OPD 5x4 2x32A 5p, 230V		40m	32A 5p	1/1	pcs
15000-66	Cable reel MAKARA-460 NK OPD 5x4 2x32A 5p, 230V		50m	32A 5p	1/1	pcs
15000-67	Cable reel MAKARA-460 NK OPD 5x6 2x32A 5p, 230V		20m	32A 5p	1/1	pcs
15000-68	Cable reel MAKARA-460 NK OPD 5x6 2x32A 5p, 230V		25m	32A 5p	1/1	pcs
15000-69	Cable reel MAKARA-460 NK OPD 5x6 2x32A 5p, 230V		30m	32A 5p	1/1	pcs
15000-70	Cable reel MAKARA-460 NK OPD 5x6 2x32A 5p, 230V		35m	32A 5p	1/1	pcs
15000-71	Cable reel MAKARA-460 NK OPD 5x6 2x32A 5p, 230V		40m	32A 5p	1/1	pcs



		Lenght	Plug	Box	Unit
15000-38	Cable reel MAKARA-460 NK OW 5x2,5 2x16A 5p, 2x230V	30m	16A 5p	1/1	pcs
15000-39	Cable reel MAKARA-460 NK OW 5x2,5 2x16A 5p, 2x230V	35m	16A 5p	1/1	pcs
15000-40	Cable reel MAKARA-460 NK OW 5x2,5 2x16A 5p, 2x230V	40m	16A 5p	1/1	pcs
15000-41	Cable reel MAKARA-460 NK OW 5x2,5 2x16A 5p, 2x230V	50m	16A 5p	1/1	pcs
15000-42	Cable reel MAKARA-460 NK OW 5x2,5 16A 5p, 32A 5p, 2x230V	30m	16A 5p	1/1	pcs
15000-43	Cable reel MAKARA-460 NK OW 5x2,5 16A 5p, 32A 5p, 2x230V	35m	16A 5p	1/1	pcs
15000-44	Cable reel MAKARA-460 NK OW 5x2,5 16A 5p, 32A 5p, 2x230V	40m	16A 5p	1/1	pcs
15000-45	Cable reel MAKARA-460 NK OW 5x2,5 16A 5p, 32A 5p, 2x230V	50m	16A 5p	1/1	pcs
15000-46	Cable reel MAKARA-460 NK OPD 5x4 2x32A 5p, 2x230V	30m	32A 5p	1/1	pcs
15000-47	Cable reel MAKARA-460 NK OPD 5x4 2x32A 5p, 2x230V	35m	32A 5p	1/1	pcs
15000-48	Cable reel MAKARA-460 NK OPD 5x4 2x32A 5p, 2x230V	40m	32A 5p	1/1	pcs
15000-49	Cable reel MAKARA-460 NK OPD 5x4 2x32A 5p, 2x230V	50m	32A 5p	1/1	pcs
15000-50	Cable reel MAKARA-460 NK OPD 5x6 2x32A 5p, 2x230V	20m	32A 5p	1/1	pcs
15000-51	Cable reel MAKARA-460 NK OPD 5x6 2x32A 5p, 2x230V	25m	32A 5p	1/1	pcs
15000-52	Cable reel MAKARA-460 NK OPD 5x6 2x32A 5p, 2x230V	30m	32A 5p	1/1	pcs
15000-53	Cable reel MAKARA-460 NK OPD 5x6 2x32A 5p, 2x230V	35m	32A 5p	1/1	pcs
15000-54	Cable reel MAKARA-460 NK OPD 5x6 2x32A 5p, 2x230V	40m	32A 5p	1/1	pcs

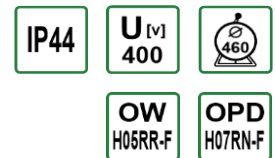

		Lenght	Plug	Box	Unit
15000-80	Cable reel MAKARA-460 NK OW 5x2,5 16A 5p, 3x230V	30m	16A 5p	1/1	pcs
15000-81	Cable reel MAKARA-460 NK OW 5x2,5 16A 5p, 3x230V	35m	16A 5p	1/1	pcs
15000-82	Cable reel MAKARA-460 NK OW 5x2,5 16A 5p, 3x230V	40m	16A 5p	1/1	pcs
15000-83	Cable reel MAKARA-460 NK OW 5x2,5 16A 5p, 3x230V	50m	16A 5p	1/1	pcs
15000-84	Cable reel MAKARA-460 NK OPD 5x4 32A 5p, 3x230V	30m	32A 5p	1/1	pcs
15000-85	Cable reel MAKARA-460 NK OPD 5x4 32A 5p, 3x230V	35m	32A 5p	1/1	pcs
15000-86	Cable reel MAKARA-460 NK OPD 5x4 32A 5p, 3x230V	40m	32A 5p	1/1	pcs
15000-87	Cable reel MAKARA-460 NK OPD 5x4 32A 5p, 3x230V	50m	32A 5p	1/1	pcs
15000-88	Cable reel MAKARA-460 NK OPD 5x6 32A 5p, 3x230V	20m	32A 5p	1/1	pcs
15000-89	Cable reel MAKARA-460 NK OPD 5x6 32A 5p, 3x230V	25m	32A 5p	1/1	pcs
15000-90	Cable reel MAKARA-460 NK OPD 5x6 32A 5p, 3x230V	30m	32A 5p	1/1	pcs
15000-91	Cable reel MAKARA-460 NK OPD 5x6 32A 5p, 3x230V	35m	32A 5p	1/1	pcs
15000-92	Cable reel MAKARA-460 NK OPD 5x6 32A 5p, 3x230V	40m	32A 5p	1/1	pcs

PLASTIC CABLE REELS GOLIA-420

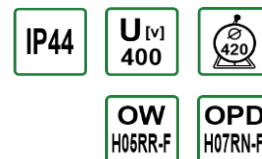

		Lenght	Plug	Box	Unit
12005-1	Cable reel GOLIA-420 OW 5x2,5 2x16A 5p, 230V	30m	16A 5p	1/1	pcs
12005-2	Cable reel GOLIA-420 OW 5x2,5 2x16A 5p, 230V	40m	16A 5p	1/1	pcs
12005-3	Cable reel GOLIA-420 OW 5x2,5 2x16A 5p, 230V	50m	16A 5p	1/1	pcs
12005-12	Cable reel GOLIA-420 OW 5x2,5 16A 5p, 32A 5p, 230V	30m	16A 5p	1/1	pcs
12005-13	Cable reel GOLIA-420 OW 5x2,5 16A 5p, 32A 5p, 230V	40m	16A 5p	1/1	pcs
12005-14	Cable reel GOLIA-420 OW 5x2,5 16A 5p, 32A 5p, 230V	50m	16A 5p	1/1	pcs
12006-14	Cable reel GOLIA-420 OPD 5x2,5 2x16A 5p, 230V	30m	16A 5p	1/1	pcs
12006-15	Cable reel GOLIA-420 OPD 5x2,5 2x16A 5p, 230V	40m	16A 5p	1/1	pcs
12006-16	Cable reel GOLIA-420 OPD 5x2,5 2x16A 5p, 230V	50m	16A 5p	1/1	pcs
12006-17	Cable reel GOLIA-420 OPD 5x2,5 16A 5p, 32A 5p, 230V	30m	16A 5p	1/1	pcs
12006-18	Cable reel GOLIA-420 OPD 5x2,5 16A 5p, 32A 5p, 230V	40m	16A 5p	1/1	pcs
12006-19	Cable reel GOLIA-420 OPD 5x2,5 16A 5p, 32A 5p, 230V	50m	16A 5p	1/1	pcs
12006-7	Cable reel GOLIA-420 OPD 5x4 2x32A 5p, 230V	30m	32A 5p	1/1	pcs
12006-8	Cable reel GOLIA-420 OPD 5x4 2x32A 5p, 230V	40m	32A 5p	1/1	pcs
12006-9	Cable reel GOLIA-420 OPD 5x4 2x32A 5p, 230V	50m	32A 5p	1/1	pcs

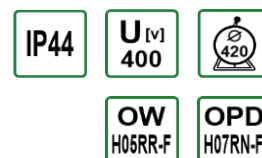

		Lenght	Plug	Box	Unit
12005-4	Cable reel GOLIA-420 OW 5x2,5 16A 5p, 2x230V	30m	16A 5p	1/1	pcs
12005-5	Cable reel GOLIA-420 OW 5x2,5 16A 5p, 2x230V	40m	16A 5p	1/1	pcs
12005-6	Cable reel GOLIA-420 OW 5x2,5 16A 5p, 2x230V	50m	16A 5p	1/1	pcs
12006-20	Cable reel GOLIA-420 OPD 5x2,5 16A 5p, 2x230V	30m	16A 5p	1/1	pcs
12006-21	Cable reel GOLIA-420 OPD 5x2,5 16A 5p, 2x230V	40m	16A 5p	1/1	pcs
12006-22	Cable reel GOLIA-420 OPD 5x2,5 16A 5p, 2x230V	50m	16A 5p	1/1	pcs
12006-1	Cable reel GOLIA-420 OPD 5x4 32A 5p, 2x230V	30m	32A 5p	1/1	pcs
12006-2	Cable reel GOLIA-420 OPD 5x4 32A 5p, 2x230V	40m	32A 5p	1/1	pcs
12006-3	Cable reel GOLIA-420 OPD 5x4 32A 5p, 2x230V	50m	32A 5p	1/1	pcs

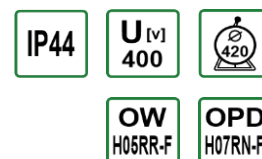

		Lenght	Plug	Box	Unit
12005-7	Cable reel GOLIA-420 OW 5x2,5 2x16A 5p	30m	16A 5p	1/1	pcs
12005-8	Cable reel GOLIA-420 OW 5x2,5 2x16A 5p	40m	16A 5p	1/1	pcs
12005-9	Cable reel GOLIA-420 OW 5x2,5 2x16A 5p	50m	16A 5p	1/1	pcs
12006-23	Cable reel GOLIA-420 OPD 5x2,5 2x16A 5p	30m	16A 5p	1/1	pcs
12006-24	Cable reel GOLIA-420 OPD 5x2,5 2x16A 5p	40m	16A 5p	1/1	pcs
12006-25	Cable reel GOLIA-420 OPD 5x2,5 2x16A 5p	50m	16A 5p	1/1	pcs
12006-4	Cable reel GOLIA-420 OPD 5x4 2x32A 5p	30m	32A 5p	1/1	pcs
12006-5	Cable reel GOLIA-420 OPD 5x4 2x32A 5p	40m	32A 5p	1/1	pcs
12006-6	Cable reel GOLIA-420 OPD 5x4 2x32A 5p	50m	32A 5p	1/1	pcs

PLASTIC CABLE REELS ALBERO-330



Type of plug: 230V IP67

		Lenght	Box	Unit
14301-1	Cable reel ALBERO-330 OW 3x1,5 3x230V	20m	1/1	pcs
14301-2	Cable reel ALBERO-330 OW 3x1,5 3x230V	25m	1/1	pcs
14301-3	Cable reel ALBERO-330 OW 3x1,5 3x230V	30m	1/1	pcs
14301-4	Cable reel ALBERO-330 OW 3x1,5 3x230V	40m	1/1	pcs
14301-5	Cable reel ALBERO-330 OW 3x1,5 3x230V	50m	1/1	pcs
14302-1	Cable reel ALBERO-330 OW 3x2,5 3x230V	20m	1/1	pcs
14302-2	Cable reel ALBERO-330 OW 3x2,5 3x230V	25m	1/1	pcs
14302-3	Cable reel ALBERO-330 OW 3x2,5 3x230V	30m	1/1	pcs
14302-4	Cable reel ALBERO-330 OW 3x2,5 3x230V	40m	1/1	pcs
14302-5	Cable reel ALBERO-330 OW 3x2,5 3x230V	50m	1/1	pcs



		Lenght	Plug	Box	Unit
14303-1	Cable reel ALBERO-330 OW 5x2,5 16A 5p, 230V	15m	16A 5p	1/1	pcs
14303-2	Cable reel ALBERO-330 OW 5x2,5 16A 5p, 230V	20m	16A 5p	1/1	pcs
14303-3	Cable reel ALBERO-330 OW 5x2,5 16A 5p, 230V	25m	16A 5p	1/1	pcs
14303-4	Cable reel ALBERO-330 OW 5x2,5 16A 5p, 230V	30m	16A 5p	1/1	pcs
14303-5	Cable reel ALBERO-330 OW 5x2,5 16A 5p, 230V	35m	16A 5p	1/1	pcs

METAL EMPTY CABLE RELLS BORDO-320



			Box	Unit
14300-206	Empty cable reel BORDO-320	16A 5p, 230V	1/1	pcs
14300-207	Empty cable reel BORDO-320	32A 5p, 230V	1/1	pcs
14300-2	Empty cable reel BORDO-320	16A 5p, 2x230V	1/1	pcs
14300-5	Empty cable reel BORDO-320	32A 5p, 2x230V	1/1	pcs

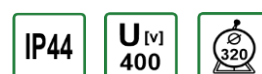

			Box	Unit
14300-22	Empty cable reel BORDO-320	16A 5p, 32A 5p	1/1	pcs
14300-4	Empty cable reel BORDO-320	2x16A 5p	1/1	pcs
14300-6	Empty cable reel BORDO-320	2x32A 5p	1/1	pcs
14300-7	Empty cable reel BORDO-320	16A 5p, 32A 5p, 230V	1/1	pcs
14300-3	Empty cable reel BORDO-320	2x16A 5p, 230V	1/1	pcs
14300-20	Empty cable reel BORDO-320	2x32A 5p, 230V	1/1	pcs

METAL EMPTY CABLE RELLS GRANDE-320

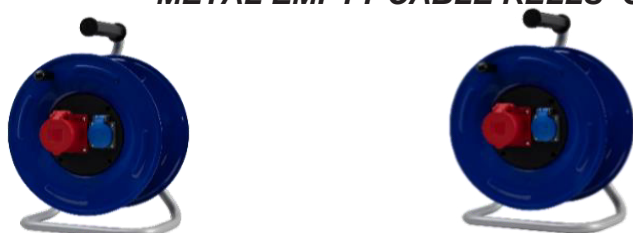

			Box	Unit
14600-52	Empty cable reel GRANDE-320	16A 5p, 230V	1/1	pcs
14600-53	Empty cable reel GRANDE-320	32A 5p, 230V	1/1	pcs

METAL EMPTY CABLE RELLS MAKARA-370



			Box	Unit
14700-21	Empty cable reel MAKARA-370	16A 5p, 32A 5p	1/1	pcs
14700-20	Empty cable reel MAKARA-370	2x16A 5p	1/1	pcs
14700-22	Empty cable reel MAKARA-370	2x32A 5p	1/1	pcs
14700-27	Empty cable reel MAKARA-370	16A 5p, 32A 5p, 230V	1/1	pcs
14700-26	Empty cable reel MAKARA-370	2x16A 5p, 230V	1/1	pcs
14700-28	Empty cable reel MAKARA-370	2x32A 5p, 230V	1/1	pcs



		Box	Unit
14700-24	Empty cable reel MAKARA-370 16A 5p, 32A 5p, 2x230V	1/1	pcs
14700-23	Empty cable reel MAKARA-370 2x16A 5p, 2x230V	1/1	pcs
14700-25	Empty cable reel MAKARA-370 2x32A 5p, 2x230V	1/1	pcs
14700-29	Empty cable reel MAKARA-370 16A 5p, 2x230V	1/1	pcs
14700-30	Empty cable reel MAKARA-370 32A 5p, 2x230V	1/1	pcs
14700-31	Empty cable reel MAKARA-370 16A 5p, 3x230V	1/1	pcs
14700-32	Empty cable reel MAKARA-370 32A 5p, 3x230V	1/1	pcs

METAL EMPTY CABLE RELLS MAKARA-460



		Box	Unit
14800-8	Empty cable reel MAKARA-460 16A 5p, 32A 5p	1/1	pcs
14800-7	Empty cable reel MAKARA-460 2x16A 5p	1/1	pcs
14800-9	Empty cable reel MAKARA-460 2x32A 5p	1/1	pcs
14800-14	Empty cable reel MAKARA-460 16A 5p, 32A 5p, 230V	1/1	pcs
14800-13	Empty cable reel MAKARA-460 2x16A 5p, 230V	1/1	pcs
14800-15	Empty cable reel MAKARA-460 2x32A 5p, 230V	1/1	pcs

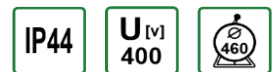

		Box	Unit
14800-11	Empty cable reel MAKARA-460 16A 5p, 32A 5p, 2x230V	1/1	pcs
14800-10	Empty cable reel MAKARA-460 2x16A 5p, 2x230V	1/1	pcs
14800-12	Empty cable reel MAKARA-460 2x32A 5p, 2x230V	1/1	pcs
14800-16	Empty cable reel MAKARA-460 16A 5p, 2x230V	1/1	pcs
14800-17	Empty cable reel MAKARA-460 32A 5p, 2x230V	1/1	pcs
14800-18	Empty cable reel MAKARA-460 16A 5p, 3x230V	1/1	pcs
14800-19	Empty cable reel MAKARA-460 32A 5p, 3x230V	1/1	pcs

METAL EMPTY CABLE RELLS MAKARA-460



			Box	Unit
15000-9	Empty cable reel MAKARA-460 NK	16A 5p, 32A 5p	1/1	pcs
15000-8	Empty cable reel MAKARA-460 NK	2x16A 5p	1/1	pcs
15000-10	Empty cable reel MAKARA-460 NK	2x32A 5p	1/1	pcs
15000-15	Empty cable reel MAKARA-460 NK	16A 5p, 32A 5p, 230V	1/1	pcs
15000-14	Empty cable reel MAKARA-460 NK	2x16A 5p, 230V	1/1	pcs
15000-16	Empty cable reel MAKARA-460 NK	2x32A 5p, 230V	1/1	pcs



			Box	Unit
15000-12	Empty cable reel MAKARA-460 NK	16A 5p, 32A 5p, 2x230V	1/1	pcs
15000-11	Empty cable reel MAKARA-460 NK	2x16A 5p, 2x230V	1/1	pcs
15000-13	Empty cable reel MAKARA-460 NK	2x32A 5p, 2x230V	1/1	pcs
15000-17	Empty cable reel MAKARA-460 NK	16A 5p, 2x230V	1/1	pcs
15000-18	Empty cable reel MAKARA-460 NK	32A 5p, 2x230V	1/1	pcs
15000-19	Empty cable reel MAKARA-460 NK	16A 5p, 3x230V	1/1	pcs
15000-20	Empty cable reel MAKARA-460 NK	32A 5p, 3x230V	1/1	pcs

PLASTIC EMPTY CABLE RELLS GOLIA-420



			Box	Unit
12004-1	Empty cable reel GOLIA-420	16A 5p, 2x230V	1/1	pcs
12004-4	Empty cable reel GOLIA-420	32A 5p, 2x230V	1/1	pcs
12004-6	Empty cable reel GOLIA-420	16A 5p, 32A 5p, 230V	1/1	pcs
12004-2	Empty cable reel GOLIA-420	2x16A 5p, 230V	1/1	pcs
12004-7	Empty cable reel GOLIA-420	2x32A 5p, 230V	1/1	pcs
12004-8	Empty cable reel GOLIA-420	16A 5p, 32A 5p	1/1	pcs
12004-3	Empty cable reel GOLIA-420	2x16A 5p	1/1	pcs
12004-5	Empty cable reel GOLIA-420	2x32A 5p	1/1	pcs

PLASTIC EMPTY CABLE RELLS



IP44 U^[V] 230

		ø outer	Equipment	Reel material	Box	Unit
14508	Empty cable reel FILO-230 4x230V	230	thermal fuse	plastic	1/1	pcs
14688	Empty cable reel FILO-260 4x230V	260	thermal fuse	plastic	1/1	pcs
14650	Empty cable reel NERO-240 3x230V	240	thermal fuse / light LED	plastic	1/1	pcs
14710	Empty cable reel NERO-290 3x230V	290	thermal fuse / light LED	plastic	1/1	pcs



IP44 U^[V] 230

		ø outer	Equipment	Reel material	Box	Unit
14708	Empty cable reel TONDA-320 4x230V	320	thermal fuse	plastic	1/1	pcs
12004-9	Empty cable reel GOLIA-420 4x230V	420	thermal fuse	plastic	1/1	pcs

METAL EMPTY CABLE RELLS



IP44 U^[V] 230

		ø outer	Equipment	Reel material	Box	Unit
14555FR	Empty cable reel MINI-210 4x230V	210	thermal fuse	metal / plastic	1/1	pcs
14569FR	Empty cable reel MIDI-290 4x230V	290	thermal fuse	metal / plastic	1/1	pcs



IP44 U^[V] 230

		ø outer	Equipment	Reel material	Box	Unit
14600FR	Empty cable reel GRANDE-320 4x230V	320	thermal fuse / light LED	metal / plastic	1/1	pcs
14300-1	Empty cable reel BORDO-320 4x230V	320	termik	metal / plastic	1/1	pcs

PLASTIC EMPTY CABLE REELS



IP44

		ø outer	Reel material	Box	Unit
11000	Empty cable reel TONDA-320	320	plastic	1/1	pcs
12003	Empty cable reel GOLIA-420 NK	420	plastic	1/1	pcs

METAL EMPTY CABLE REELS



IP44

		ø outer	Reel material	Box	Unit
14600	Metal empty cable reel GRANDE-320	320	metal / plastic	1/1	pcs
14300	Metal empty cable reel BORDO-320	320	metal / plastic	1/1	pcs
14700	Metal empty cable reel MAKARA-370	370	metal / plastic	1/1	pcs



IP44

		ø outer	Reel material	Box	Unit
14800	Metal empty cable reel MAKARA-460	460	metal / plastic	1/1	pcs
15000	Metal empty cable reel MAKARA-460 NK	460	metal / plastic	1/1	pcs



Intended for TONDA-320

Intended for FILO-230
FILO-260
MINI-210
MIDI-290

		U [V]	I [A]	Box	Unit
1921	Thermal switch 1 phase 220V	230V	16A	1/1	pcs
1922	Thermal switch 3 phase 380V	400V	16A	1/1	pcs
1908	Disc for empty cable reel diameter-145 4x230V		IP44	1/1	pcs
1909	Disc for empty cable reel diameter-140 4x230V		IP44	1/1	pcs

PLUGS FOR INDUSTRIAL USING 230V



		Protection class	Amper	Box	Unit
F7.0143	Straight Plug 16A 3p black	IP44	16A	1/10	pcs
F7.0144	Straight Plug 32A 3p black	IP44	32A	1/8	pcs
F7.0145	Straight Plug 16A 3p black	IP67	16A	1/8	pcs
F7.0146	Straight Plug 32A 3p black	IP67	32A	1/3	pcs

CONNECTOR SOCKETS 230V



		Protection class	Amper	Box	Unit
F7.0147	Connector Socket 16A 3p black	IP44	16A	1/10	pcs
F7.0148	Connector Socket 32A 3p black	IP44	32A	1/8	pcs
F7.0149	Connector Socket 16A 3p black	IP67	16A	1/10	pcs
F7.0150	Connector Socket 32A 3p black	IP67	32A	1/8	pcs

PANEL MOUNTED SOCKETS 230V



		Protection class	Amper	Box	Unit
F7.0151	Panel Mounted Socket 16A 3p black	IP44	16A	1/15	pcs
F7.0152	Panel Mounted Socket 32A 3p black	IP44	32A	1/8	pcs
F7.0153	Panel Mounted Socket 16A 3p black	IP67	16A	1/8	pcs
F7.0154	Panel Mounted Socket 32A 3p black	IP67	32A	1/4	pcs

PANEL MOUNTED PLUGS 230V



		Protection class	Amper	Box	Unit
F7.0155	Panel Mounted Plug 16A 3p black	IP44	16A	1/10	pcs
F7.0156	Panel Mounted Plug 32A 3p black	IP44	32A	1/8	pcs
F7.0157	Panel Mounted Plug 16A 3p black	IP67	16A	1/10	pcs
F7.0158	Panel Mounted Plug 32A 3p black	IP67	32A	1/6	pcs

SOCKETS FOR INDUSTRIAL USING



		Dimensions flange [mm]	Plug type	Standard	Box	Unit
71091	Panel socket 230V black - B	50x50	E	French	1/30	pcs
71092	Panel socket 230V black - B SCHUKO	50x50	F	SCHUKO	1/30	pcs

STRAIGHT PLUGS 400V



NEW

PA Ms58
U [V] 380-415 Hz 50-60

			Protection class	Pilot	Amper	Pole	Box	Unit
F7.0159	Straight Plug	16A 5p black	IP44		16A	5	1/8	pcs
F7.0160	Straight Plug	32A 5p black	IP44		32A	5	1/8	pcs
F7.0161	Straight Plug	16A 5p black	IP67	---	16A	5	1/4	pcs
F7.0162	Straight Plug	32A 5p black	IP67	---	32A	5	1/3	pcs
F7.0163	Straight Plug	63A 5p black	IP67	YES	63A	5	1/1	pcs

CONNECTOR SOCKETS 400V



IP44 PA Ms58
U [V] 380-415 Hz 50-60

					Amper	Pole	Box	Unit
F7.0164	Connector Socket	16A 5p black			16A	5	1/8	pcs
F7.0165	Connector Socket	32A 5p black			32A	5	1/8	pcs



IP67 PA Ms58
U [V] 380-415 Hz 50-60

				Pilot	Amper	Pole	Box	Unit
F7.0166	Connector Socket	16A 5p black		---	16A	5	1/4	
F7.0167	Connector Socket	32A 5p black		---	32A	5	1/3	
F7.0168	Connector Socket	63A 5p black		YES	63A	5	1/1	pcs

ANGLED PANEL SOCKETS 400V



IP44 PA Ms58
U [V] 380-415 Hz 50-60

					Amper	Pole	Flange [mm]	Box	Unit
F7.0132	Angled Panel Socket	16A 5p black			16A	5	76x86 mm	1/10	pcs
F7.0133	Angled Panel Socket	32A 5p black			32A	5	82x98 mm	1/10	pcs

PANEL MOUNTED SOCKETS 400V



IP44	PA	Ms58
U [V] 380-415	Hz 50-60	

		Amper	Pole	Flange [mm]	Box	Unit
F7.0169	Panel Mounted Socket 16A 5p black	16A	5	75x75 mm	1/15	pcs
F7.0170	Panel Mounted Socket 32A 5p black	32A	5	75x75 mm	1/8	pcs

PANEL MOUNTED SOCKETS 400V



IP67	PA	Ms58
U [V] 380-415	Hz 50-60	

		Pilot	Amper	Pole	Flange [mm]	Box	Unit
F7.0171	Panel Mounted Socket 16A 5p black	---	16A	5	75x75 mm	1/6	pcs
F7.0172	Panel Mounted Socket 32A 5p black	---	32A	5	75x75 mm	1/4	pcs
F7.0173	Panel Mounted Socket 63A 5p black	YES	63A	5	107x112 mm	1/1	pcs

PANEL MOUNTED PLUGS 400V



IP44	PA	Ms58
U [V] 380-415	Hz 50-60	

		Amper	Pole	Flange [mm]	Box	Unit
F7.0174	Panel Mounted Plug 16A 5p black	16A	5	75x75 mm	1/8	pcs
F7.0176	Panel Mounted Plug 32A 5p black	32A	5	75x75 mm	1/8	pcs



IP67	PA	Ms58
U [V] 380-415	Hz 50-60	

		Pilot	Amper	Pole	Flange [mm]	Box	Unit
F7.0175	Panel Mounted Plug 16A 5p black	---	16A	5	83x94 mm	1/6	pcs
F7.0177	Panel Mounted Plug 32A 5p black	---	32A	5	83x94 mm	1/6	pcs
F7.0178	Panel Mounted Plug 63A 5p black	YES	63A	5	107x112 mm	1/1	pcs

PLUGS AND SOCKETS 24V



IP44	PA	Ms58
U _[V] 24	Hz 50-60	

		Amper	Box	Unit
F7.0068	Straight Plug 24V 16A 2p	16A	1/10	pcs
F7.0070	Angled Surface Socket 16A 2p 24V	16A	1/3	pcs
F7.0069	Connector Socket 16A 2p 24V	16A	1/10	pcs
F7.0071	Panel Mounted Socket 16A 2p 24V flange 55x55	16A	1/20	pcs

PLUGS FOR INDUSTRIAL USING 230V



IP44	PA	Ms58
U _[V] 220-250	Hz 50-60	

		Amper	Box	Unit
F7.0105	Angled Rotate Plug 16A 3p	16A	1/6	pcs
F7.0001	Straight Plug 16A 3p 250V	16A	1/10	pcs
F7.0051	Straight Plug 32A 3p 250V	32A	1/8	pcs



IP67	PA	Ms58
U _[V] 220-250	Hz 50-60	

		Amper	Box	Unit
F7.0106	Straight Plug 16A 3p 250V	16A	1/8	pcs
F7.0113	Straight Plug 32A 3p 250V	32A	1/3	pcs
F7.0084	Watertight cover for angled Surface Plug 16/3		1/1	pcs
F7.0135	Watertight cover for angled Surface Plug 16/3		1/1	pcs

ANGLED SURFACE PLUGS 230V



IP44	PA	Ms58
U _[V] 220-250	Hz 50-60	

		Amper	Box	Unit
F7.0049	Angled Surface Socket 16A 3p	16A	1/3	pcs
F7.0053	Angled Surface Socket 32A 3p	32A	1/3	pcs



IP67	PA	Ms58
U _[V] 220-250	Hz 50-60	

		Amper	Box	Unit
F7.0107	Angled Surface Socket 16A 3p	16A	1/3	pcs
F7.0114	Angled Surface Socket 32A 3p	32A	1/3	pcs

CONNECTOR SOCKETS 230V



- F7.0013 Connector Socket 16A 3p
- F7.0052 Connector Socket 32A 3p

IP44	PA	Ms58
------	----	------

U [V] 220-250	H _z 50-60	
------------------	-------------------------	--

Amper	Box	Unit
16A	1/10	pcs
32A	1/8	pcs



- F7.0108 Connector Socket 16A 3p
- F7.0115 Connector Socket 32A 3p

IP67	PA	Ms58
------	----	------

U [V] 220-250	H _z 50-60	
------------------	-------------------------	--

Amper	Box	Unit
16A	1/8	pcs
32A	1/3	pcs

ANGLED PANEL SOCKETS 230V



- F7.0050 Angled Panel Socket 16A 3p
- F7.0083 Angled Panel Socket 32A 3p

IP44	PA	Ms58
------	----	------

U [V] 220-250	H _z 50-60	
------------------	-------------------------	--

Amper	Box	Unit
16A	1/8	pcs
32A	1/4	pcs



- F7.0110 Angled Panel Socket 16A 3p
- F7.0111 Angled Panel Socket 32A 3p

IP67	PA	Ms58
------	----	------

U [V] 220-250	H _z 50-60	
------------------	-------------------------	--

Amper	Box	Unit
16A	1/6	pcs
32A	1/4	pcs

PANEL MOUNTED SOCKETS 230V



- F7.0109 Panel Mounted Socket 16A 3p
- F7.0096 Panel Mounted Socket 32A 3p

IP44	PA	Ms58
------	----	------

U [V] 220-250	H _z 50-60	
------------------	-------------------------	--

Amper	Box	Unit
16A	1/15	pcs
32A	1/8	pcs



- F7.0116 Panel Mounted Socket 16A 3p
- F7.0117 Panel Mounted Socket 32A 3p

IP67	PA	Ms58
------	----	------

U [V] 220-250	H _z 50-60	
------------------	-------------------------	--

Amper	Box	Unit
16A	1/8	pcs
32A	1/4	pcs

ANGLED SURFACE PLUGS 230V



		Amper	Box	Unit
F7.0090	Angled Surface Plug 16A 3p	16A	1/6	pcs
F7.0112	Angled Surface Plug 32A 3p	32A	1/3	pcs
F7.0092	Protective cover for angled Surface Plug 16/3		1/1	pcs
F7.0095	Protective cover for angled Surface Plug 32/5 32/4 32/3		1/1	pcs



		Amper	Box	Unit
F7.0091	Angled Surface Plug 16A 3p	16A	1/3	pcs
F7.0118	Angled Surface Plug 32A 3p	32A	1/3	pcs
F7.0084	Watertight cover for angled Surface Plug 16/3		1/1	pcs
F7.0135	Watertight cover for angled Surface Plug 16/3		1/1	pcs

PANEL MOUNTED PLUGS 230V



		Amper	Box	Unit
F7.0088	Panel Mounted Plug 16A 3p	16A	1/10	pcs
F7.0119	Panel Mounted Plug 32A 3p	32A	1/8	pcs



		Amper	Box	Unit
F7.0089	Panel Mounted Plug 16A 3p	16A	1/10	pcs
F7.0120	Panel Mounted Plug 32A 3p	32A	1/6	pcs
F7.0084	Watertight cover for angled Surface Plug 16/3		1/1	pcs
F7.0135	Watertight cover for angled Surface Plug 16/3		1/1	pcs

STRAIGHT PLUGS 400V



IP44	PA	Ms58
U [V] 380-450	Hz 50-60	

		Amper	Pole	Box	Unit
F7.0002	Straight Plug 16A 4p	16A	4	1/8	pcs
F7.0003	Straight Plug 16A 5p	16A	5	1/8	pcs
F7.0004	Straight Plug 32A 4p	32A	4	1/8	pcs
F7.0005	Straight Plug 32A 5p	32A	5	1/8	pcs

PHASE INVERTER PLUGS 400V



IP44	PA	Ms58
U [V] 380-450	Hz 50-60	

		Amper	Pole	Box	Unit
F7.0027	Inverter plug 16A 5p	16A	5	1/8	pcs
F7.0028	Inverter plug 32A 5p	32A	5	1/8	pcs

ANGLED ROTATED PLUGS 400V



IP44	PA	Ms58
U [V] 380-450	Hz 50-60	

		Amper	Pole	Box	Unit
F7.0104	Angled Rotate Plug 16A 4p	16A	4	1/6	pcs
F7.0061	Angled Rotate Plug 16A 5p	16A	5	1/6	pcs
F7.0103	Angled Rotate Plug 32A 4p	32A	4	1/6	pcs
F7.0062	Angled Rotate Plug 32A 5p	32A	5	1/6	pcs

STRAIGHT PLUGS 400V



IP67	PA	Ms58
U [V] 380-450	Hz 50-60	

		Pilot	Amper	Pole	Box	Unit
F7.0035	Straight Plug 16A 5p	---	16A	5	1/4	pcs
F7.0036	Straight Plug 32A 5p	---	32A	5	1/3	pcs
F7.0006	Straight Plug 63A 5p	YES	63A	5	1/1	pcs
F7.0045	Straight Plug 125A 5p	YES	125A	5	1/1	pcs

ANGLED SURFACE SOCKETS / KOMBI 400V



IP44	PA	Ms58
	Hz 50-60	

		Amper	U [V]	Pole	Box	Unit
F7.0029	Angled Surface Socket 16A 4p	16A	380V - 450V	4	1/3	pcs
F7.0030	Angled Surface Socket 16A 5p	16A	380V - 450V	5	1/3	pcs
F7.0031	Angled Surface Socket 32A 4p	32A	380V - 450V	4	1/3	pcs
F7.0032	Angled Surface Socket 32A 5p	32A	380V - 450V	5	1/3	pcs
F3.0300	Angled Surface Socket 16A 5p + 230V	16A	380V - 450V / 230V	5 / 3	1/3	pcs
F3.0301	Angled Surface Socket 32A 5p + 230V	32A	380V - 450V / 230V	5 / 3	1/3	pcs

ANGLED SURFACE SOCKETS 400V



IP67	PA	Ms58
U [V] 380-450	Hz 50-60	

		Pilot	Amper	Pole	Box	Unit
F7.0039	Angled Surface Socket 16A 5p	---	16A	5	1/3	pcs
F7.0040	Angled Surface Socket 32A 5p	---	32A	5	1/3	pcs
F7.0033	Angled Surface Socket 63A 5p	YES	63A	5	1/1	pcs
F7.0047	Angled Surface Socket 125A 5p	YES	125A	5	1/1	pcs

CONNECTOR SOCKETS 400V



IP44	PA	Ms58
U [V] 380-450	Hz 50-60	

		Amper	Pole	Box	Unit
F7.0014	Connector Socket 16A 4p	16A	4	1/8	pcs
F7.0015	Connector Socket 16A 5p	16A	5	1/8	pcs
F7.0016	Connector Socket 32A 4p	32A	4	1/8	pcs
F7.0017	Connector Socket 32A 5p	32A	5	1/8	pcs



IP67	PA	Ms58
U [V] 380-450	Hz 50-60	

		Pilot	Amper	Box	Unit
F7.0037	Connector Socket 16A 5p	---	16A	1/4	pcs
F7.0038	Connector Socket 32A 5p	---	32A	1/3	pcs
F7.0018	Connector Socket 63A 5p	YES	63A	1/1	pcs
F7.0046	Connector Socket 125A 5p	YES	125A	1/1	pcs

ANGLED PANEL SOCKETS 400V



IP44 PA Ms58

U_[V] 380-450 Hz 50-60



		Amper	Pole	Flange [mm]	Box	Unit
F7.0019	Angled Panel Socket 16A 4p	16A	4	76x86	1/10	pcs
F7.0020	Angled Panel Socket 16A 5p	16A	5	76x86	1/10	pcs
F7.0021	Angled Panel Socket 32A 4p	32A	4	82x98	1/10	pcs
F7.0022	Angled Panel Socket 32A 5p	32A	5	82x98	1/10	pcs
F7.0132	Angled Panel Socket 16A 5p black	16A	5	76x86	1/10	pcs
F7.0133	Angled Panel Socket 32A 5p black	32A	5	82x98	1/10	pcs

ANGLED PANEL SOCKETS WITH BOX 400V



IP44 PA Ms58

U_[V] 380-450 Hz 50-60



		Amper	Pole	Box	Unit
F7.0075	Angled Panel Socket 16A 4p with box	16A	4	1/1	pcs
F7.0076	Angled Panel Socket 16A 5p with box	16A	5	1/1	pcs
F7.0077	Angled Panel Socket 32A 4p with box	32A	4	1/1	pcs
F7.0078	Angled Panel Socket 32A 5p with box	32A	5	1/1	pcs



ABS

		Dimensions [mm]	Box	Unit
F7.0073	Box for Angled Panel Socket 16A	70x80x68	1/1	pcs
F7.0074	Box for Angled Panel Socket 32A	77x92x71	1/1	pcs

ANGLED PANEL SOCKETS 400V



IP67 PA Ms58

U_[V] 380-450 Hz 50-60



		Pilot	Amper	Flange [mm]	Box	Unit
F7.0041	Angled Panel Socket 16A 5p	---	16A	85x86	1/6	pcs
F7.0042	Angled Panel Socket 32A 5p	---	32A	82x98	1/4	pcs
F7.0034	Angled Panel Socket 63A 5p	YES	63A	107x114	1/1	pcs
F7.0134	Angled Panel Socket 125A 5p	YES	125A	114x117	1/1	pcs

PANEL MOUNTED SOCKETS 400V

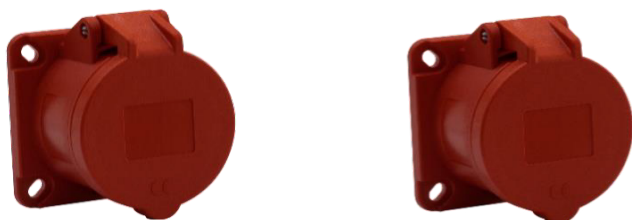

		Amper	Pilot	Flange [mm]	Box	Unit
F7.0079	Panel Mounted Socket 16A 4p	16A	4	75x75	1/15	pcs
F7.0080	Panel Mounted Socket 16A 5p	16A	5	75x75	1/15	pcs
F7.0081	Panel Mounted Socket 32A 4p	32A	4	75x75	1/8	pcs
F7.0082	Panel Mounted Socket 32A 5p	32A	5	75x75	1/8	pcs

SCREWLESS CONNECTION SOCKETS 400V



		Amper	Box	Unit
F7.0137	Screwless Connection Socket 16A 5p	16A	1/8	pcs
F7.0138	Screwless Connection Socket 32A 5p	32A	1/8	pcs

PANEL MOUNTED SOCKETS 400V



		Pilot	Amper	Flange [mm]	Box	Unit
F7.0043	Panel Mounted Socket 16A 5p	---	16A	75x75	1/6	pcs
F7.0044	Panel Mounted Socket 32A 5p	---	32A	75x75	1/4	pcs
F7.0102	Panel Mounted Socket 63A 5p	YES	63A	107x112	1/1	pcs
F7.0048	Panel Mounted Socket 125A 5p	YES	125A	120x120	1/1	pcs

PANEL MOUNTED PLUGS 400V



		Amper	Pole	Flange [mm]	Box	Unit
F7.0100	Panel Mounted Plug 16A 4p	16A	4	75x75	1/10	pcs
F7.0059	Panel Mounted Plug 16A 5p	16A	5	75x75	1/8	pcs
F7.0101	Panel Mounted Plug 32A 4p	32A	4	75x75	1/8	pcs
F7.0060	Panel Mounted Plug 32A 5p	32A	5	75x75	1/8	pcs

PANEL MOUNTED PLUG 400V

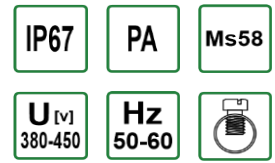

		Pilot	Amper	Flange [mm]	Box	Unit
F7.0063	Panel Mounted Plug 16A 5p	---	16A	83x94	1/6	pcs
F7.0064	Panel Mounted Plug 32A 5p	---	32A	83x94	1/6	pcs
F7.0065	Panel Mounted Plug 63A 5p	YES	63A	107x112	1/1	pcs
F7.0130	Panel Mounted Plug 125A 5p	YES	125A	120x120	1/1	pcs
F7.0085	Watertight cover for angled Surface Plug 16/5				1/1	pcs
F7.0086	Watertight cover for angled Surface Plug 32/5				1/1	pcs
F7.0087	Watertight cover for angled Surface Plug 63/5				1/1	pcs
F7.0136	Watertight cover for angled Surface Plug 125/5				1/1	pcs

ANGLED SURFACE PLUGS 400V

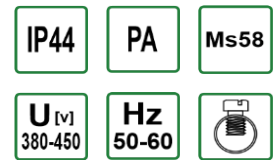

		Amper	Pole	Box	Unit
F7.0097	Angled Surface Plug 16A 4p	16A	4	1/6	pcs
F7.0054	Angled Surface Plug 16A 5p	16A	5	1/3	pcs
F7.0098	Angled Surface Plug 32A 4p	32A	4	1/3	pcs
F7.0055	Angled Surface Plug 32A 5p	32A	5	1/3	pcs
F7.0093	Protective cover for angled Surface Plug 16/4			1/1	pcs
F7.0094	Protective cover for angled Surface Plug 16/5			1/1	pcs
F7.0095	Protective cover for angled Surface Plug 32/5 32/4 32/3			1/1	pcs

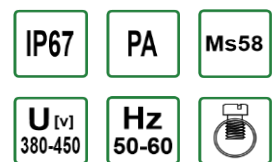

		Pilot	Amper	Box	Unit
F7.0056	Angled Surface Plug 16A 5p	---	16A	1/3	pcs
F7.0057	Angled Surface Plug 32A 5p	---	32A	1/3	pcs
F7.0058	Angled Surface Plug 63A 5p	YES	63A	1/1	pcs
F7.0131	Angled Surface Plug 125A 5p	YES	125A	1/1	pcs
F7.0085	Watertight cover for angled Surface Plug 16/5			1/1	pcs
F7.0086	Watertight cover for angled Surface Plug 32/5			1/1	pcs
F7.0087	Watertight cover for angled Surface Plug 63/5			1/1	pcs
F7.0136	Watertight cover for angled Surface Plug 125/5			1/1	pcs

PANEL SWITCHES 3-PHASE



IP65

		Switch	Flange dimensions	Box	Unit
F3.1085	Panel closing switch 16A 3P yellow-red	0-1	48x48 mm	1/1	pcs
F3.1089	Panel closing switch 32A 3P yellow-red	0-1	64x64 mm	1/1	pcs
F3.1086	Panel closing switch 16A 3P yellow-red	left-right	48x48 mm	1/1	pcs
F3.1090	Panel closing switch 32A 3P yellow-red	left-right	64x64 mm	1/1	pcs



IP65

		Switch	Flange dimensions	Box	Unit
F3.0200	Switch panel 16A 3P	0-1	48x48 mm	1/1	pcs
F3.0475	Switch panel 25A 3P	0-1	64x64 mm	1/1	pcs
F3.0202	Switch panel 32A 3P	0-1	64x64 mm	1/1	pcs
F3.0262	Switch panel 63A 3P	0-1	64x64 mm	1/1	pcs
F3.0201	Switch panel 16A 3P	left-right	48x48 mm	1/1	pcs
F3.0476	Switch panel 25A 3P	left-right	64x64 mm	1/1	pcs
F3.0203	Switch panel 32A 3P	left-right	64x64 mm	1/1	pcs
F3.0263	Switch panel 63A 3P	left-right	64x64 mm	1/1	pcs



ABS

		Cased dimensions	Box	Unit
F3.2616	Case for switch panel 16A left-right, 0-1	66x66x70 mm	1/1	pcs
F3.2617	Case for switch panel 32A left-right, 0-1	110x110x107 mm	1/1	pcs

CASED SWITCHES 3-PHASE



IP65

		Switch	Cased dimensions	Box	Unit
F3.0204	Cased switch 16A 3P	0-1	69x69x95 mm	1/1	pcs
F3.0477	Cased switch 25A 3P	0-1	114x114x140 mm	1/1	pcs
F3.0206	Cased switch 32A 3P	0-1	114x114x140 mm	1/1	pcs
F3.0260	Cased switch 63A 3P	0-1	114x114x140 mm	1/1	pcs
F3.0205	Cased switch 16A 3P	left-right	69x69x95 mm	1/1	pcs
F3.0478	Cased switch 25A 3P	left-right	114x114x140 mm	1/1	pcs
F3.0207	Cased switch 32A 3P	left-right	114x114x140 mm	1/1	pcs



NEW

IP65 U [V] 400



Hz 50-60



		Switch	Cased dimensions	Box	Unit
F3.2200	Cased switch WS-20 20A	0-1	100x79x100 mm	1/1	pcs
F3.2201	Cased switch WS-25 25A	0-1	125x100x120 mm	1/1	pcs
F3.2202	Cased switch WS-32 32A	0-1	125x100x120 mm	1/1	pcs



NEW

IP65 U [V] 400



Hz 50-60



		Switch	Cased dimensions	Box	Unit
F3.2203	Cased switch WS-40 40A	0-1	176x115x135 mm	1/1	pcs
F3.2204	Cased switch WS-63 63A	0-1	240x159x164 mm	1/1	pcs
F3.2205	Cased switch WS-100 100A	0-1	240x159x164 mm	1/1	pcs

PLUGS AND SOCKETS 24V



IP44	PA	Ms58
U _[V] 24	Hz 50-60	

		Amper	Box	Unit
F7.0068	Straight Plug 24V 16A 2p	16A	1/10	pcs
F7.0070	Angled Surface Socket 16A 2p 24V	16A	1/3	pcs
F7.0069	Connector Socket 16A 2p 24V	16A	1/10	pcs
F7.0071	Panel Mounted Socket 16A 2p 24V flange 55x55	16A	1/20	pcs

PLUGS FOR INDUSTRIAL USING 230V



IP44	PA	Ms58
U _[V] 220-250	Hz 50-60	

		Amper	Box	Unit
F7.0105	Angled Rotate Plug 16A 3p	16A	1/6	pcs
F7.0001	Straight Plug 16A 3p 250V	16A	1/10	pcs
F7.0051	Straight Plug 32A 3p 250V	32A	1/8	pcs



IP67	PA	Ms58
U _[V] 220-250	Hz 50-60	

		Amper	Box	Unit
F7.0106	Straight Plug 16A 3p 250V	16A	1/8	pcs
F7.0113	Straight Plug 32A 3p 250V	32A	1/3	pcs
F7.0084	Watertight cover for angled Surface Plug 16/3		1/1	pcs
F7.0135	Watertight cover for angled Surface Plug 16/3		1/1	pcs

ANGLED SURFACE PLUGS 230V



IP44	PA	Ms58
U _[V] 220-250	Hz 50-60	

		Amper	Box	Unit
F7.0049	Angled Surface Socket 16A 3p	16A	1/3	pcs
F7.0053	Angled Surface Socket 32A 3p	32A	1/3	pcs



IP67	PA	Ms58
U _[V] 220-250	Hz 50-60	

		Amper	Box	Unit
F7.0107	Angled Surface Socket 16A 3p	16A	1/3	pcs
F7.0114	Angled Surface Socket 32A 3p	32A	1/3	pcs

CONNECTOR SOCKETS 230V



F7.0013 Connector Socket 16A 3p
F7.0052 Connector Socket 32A 3p

IP44 PA Ms58

U [V] 220-250 Hz 50-60

Amper	Box	Unit
16A	1/10	pcs
32A	1/8	pcs



F7.0108 Connector Socket 16A 3p
F7.0115 Connector Socket 32A 3p

IP67 PA Ms58

U [V] 220-250 Hz 50-60

Amper	Box	Unit
16A	1/8	pcs
32A	1/3	pcs

ANGLED PANEL SOCKETS 230V



F7.0050 Angled Panel Socket 16A 3p
F7.0083 Angled Panel Socket 32A 3p

IP44 PA Ms58

U [V] 220-250 Hz 50-60

Amper	Box	Unit
16A	1/8	pcs
32A	1/4	pcs



F7.0110 Angled Panel Socket 16A 3p
F7.0111 Angled Panel Socket 32A 3p

IP67 PA Ms58

U [V] 220-250 Hz 50-60

Amper	Box	Unit
16A	1/6	pcs
32A	1/4	pcs



F7.0109 Panel Mounted Socket 16A 3p
F7.0096 Panel Mounted Socket 32A 3p

IP44 PA Ms58

U [V] 220-250 Hz 50-60

Amper	Box	Unit
16A	1/15	pcs
32A	1/8	pcs



F7.0116 Panel Mounted Socket 16A 3p
F7.0117 Panel Mounted Socket 32A 3p

IP67 PA Ms58

U [V] 220-250 Hz 50-60

Amper	Box	Unit
16A	1/8	pcs
32A	1/4	pcs

ANGLED SURFACE PLUGS 230V



		Amper	Box	Unit
F7.0090	Angled Surface Plug 16A 3p	16A	1/6	pcs
F7.0112	Angled Surface Plug 32A 3p	32A	1/3	pcs
F7.0092	Protective cover for angled Surface Plug 16/3		1/1	pcs
F7.0095	Protective cover for angled Surface Plug 32/5 32/4 32/3		1/1	pcs



		Amper	Box	Unit
F7.0091	Angled Surface Plug 16A 3p	16A	1/3	pcs
F7.0118	Angled Surface Plug 32A 3p	32A	1/3	pcs
F7.0084	Watertight cover for angled Surface Plug 16/3		1/1	pcs
F7.0135	Watertight cover for angled Surface Plug 16/3		1/1	pcs

PANEL MOUNTED PLUGS 230V



		Amper	Box	Unit
F7.0088	Panel Mounted Plug 16A 3p	16A	1/10	pcs
F7.0119	Panel Mounted Plug 32A 3p	32A	1/8	pcs



		Amper	Box	Unit
F7.0089	Panel Mounted Plug 16A 3p	16A	1/10	pcs
F7.0120	Panel Mounted Plug 32A 3p	32A	1/6	pcs
F7.0084	Watertight cover for angled Surface Plug 16/3		1/1	pcs
F7.0135	Watertight cover for angled Surface Plug 16/3		1/1	pcs

PLUGS 400V



IP44	PA	Ms58
U _[V] 380-450	Hz 50-60	

		Amper	Pole	Box	Unit
F7.0002	Straight Plug 16A 4p	16A	4	1/8	pcs
F7.0003	Straight Plug 16A 5p	16A	5	1/8	pcs
F7.0004	Straight Plug 32A 4p	32A	4	1/8	pcs
F7.0005	Straight Plug 32A 5p	32A	5	1/8	pcs

PHASE INVERTER PLUGS 400V



IP44	PA	Ms58
U _[V] 380-450	Hz 50-60	

		Amper	Box	Unit
F7.0027	Inverter plug 16A 5p	16A	1/8	pcs
F7.0028	Inverter plug 32A 5p	32A	1/8	pcs

ANGLED ROTATED PLUGS 400V



IP44	PA	Ms58
U _[V] 380-450	Hz 50-60	

		Amper	Pole	Box	Unit
F7.0104	Angled Rotate Plug 16A 4p	16A	4	1/6	pcs
F7.0061	Angled Rotate Plug 16A 5p	16A	5	1/6	pcs
F7.0103	Angled Rotate Plug 32A 4p	32A	4	1/6	pcs
F7.0062	Angled Rotate Plug 32A 5p	32A	5	1/6	pcs

PLUGS 400V



IP67	PA	Ms58
U _[V] 380-450	Hz 50-60	

		Pilot	Amper	Box	Unit
F7.0035	Straight Plug 16A 5p	---	16A	1/4	pcs
F7.0036	Straight Plug 32A 5p	---	32A	1/3	pcs
F7.0006	Straight Plug 63A 5p	YES	63A	1/1	pcs
F7.0045	Straight Plug 125A 5p	YES	125A	1/1	pcs

ANGLED SURFACE SOCKET / KOMBI 400V



IP44	PA	Ms58
	Hz 50-60	

		Amper	U [V]	Pole	Box	Unit
F7.0029	Angled Surface Socket 16A 4p	16A	380V - 450V	4	1/3	pcs
F7.0030	Angled Surface Socket 16A 5p	16A	380V - 450V	5	1/3	pcs
F7.0031	Angled Surface Socket 32A 4p	32A	380V - 450V	4	1/3	pcs
F7.0032	Angled Surface Socket 32A 5p	32A	380V - 450V	5	1/3	pcs
F3.0300	Angled Surface Socket 16A 5p + 230V	16A	380V - 450V / 230V	5 / 3	1/3	pcs
F3.0301	Angled Surface Socket 32A 5p + 230V	32A	380V - 450V / 230V	5 / 3	1/3	pcs

ANGLED SURFACE SOCKET 400V



IP67	PA	Ms58
U [V] 380-450	Hz 50-60	

		Pilot	Amper	Box	Unit
F7.0039	Angled Surface Socket 16A 5p	---	16A	1/3	pcs
F7.0040	Angled Surface Socket 32A 5p	---	32A	1/3	pcs
F7.0033	Angled Surface Socket 63A 5p	YES	63A	1/1	pcs
F7.0047	Angled Surface Socket 125A 5p	YES	125A	1/1	pcs

CONNECTOR SOCKET 400V



IP44	PA	Ms58
U [V] 380-450	Hz 50-60	

		Amper	Pole	Box	Unit
F7.0014	Connector Socket 16A 4p	16A	4	1/8	pcs
F7.0015	Connector Socket 16A 5p	16A	5	1/8	pcs
F7.0016	Connector Socket 32A 4p	32A	4	1/8	pcs
F7.0017	Connector Socket 32A 5p	32A	5	1/8	pcs



IP67	PA	Ms58
U [V] 380-450	Hz 50-60	

		Pilot	Amper	Box	Unit
F7.0037	Connector Socket 16A 5p	---	16A	1/4	pcs
F7.0038	Connector Socket 32A 5p	---	32A	1/3	pcs
F7.0018	Connector Socket 63A 5p	YES	63A	1/1	pcs
F7.0046	Connector Socket 125A 5p	YES	125A	1/1	pcs

ANGLED PANEL SOCKETS 400V

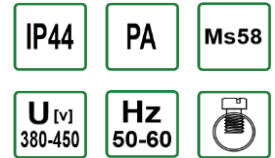

		Amper	Pole	Flange [mm]	Box	Unit
F7.0019	Angled Panel Socket 16A 4p	16A	4	76x86	1/10	pcs
F7.0020	Angled Panel Socket 16A 5p	16A	5	76x86	1/10	pcs
F7.0021	Angled Panel Socket 32A 4p	32A	4	82x98	1/10	pcs
F7.0022	Angled Panel Socket 32A 5p	32A	5	82x98	1/10	pcs

ANGLED PANEL SOCKETS WITH BOX 400V

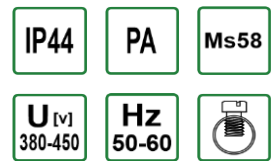

		Amper	Pole	Box	Unit
F7.0075	Angled Panel Socket 16A 4p with box	16A	4	1/1	pcs
F7.0076	Angled Panel Socket 16A 5p with box	16A	5	1/1	pcs
F7.0077	Angled Panel Socket 32A 4p with box	32A	4	1/1	pcs
F7.0078	Angled Panel Socket 32A 5p with box	32A	5	1/1	pcs



		Dimensions [mm]	Box	Unit
F7.0073	Box for Angled Panel Socket 16A	70x80x68	1/1	pcs
F7.0074	Box for Angled Panel Socket 32A	77x92x71	1/1	pcs

ANGLED PANEL SOCKETS 400V

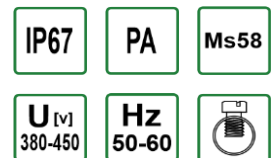

		Pilot	Amper	Flange [mm]	Box	Unit
F7.0041	Angled Panel Socket 16A 5p	---	16A	85x86	1/6	pcs
F7.0042	Angled Panel Socket 32A 5p	---	32A	82x98	1/4	pcs
F7.0034	Angled Panel Socket 63A 5p	YES	63A	107x114	1/1	pcs
F7.0134	Angled Panel Socket 125A 5p	YES	125A	114x117	1/1	pcs

STRAIGHT PANEL SOCKET 400V

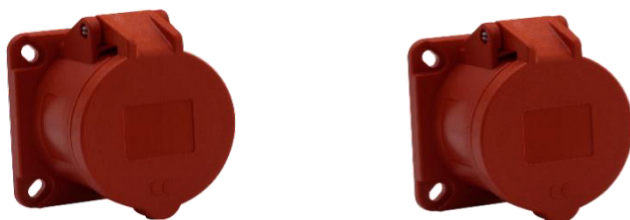

		Amper	Pilot	Flange [mm]	Box	Unit
F7.0079	Panel Mounted Socket 16A 4p	16A	4	75x75	1/15	pcs
F7.0080	Panel Mounted Socket 16A 5p	16A	5	75x75	1/15	pcs
F7.0081	Panel Mounted Socket 32A 4p	32A	4	75x75	1/8	pcs
F7.0082	Panel Mounted Socket 32A 5p	32A	5	75x75	1/8	pcs

SCREWLESS CONNECTION SOCKET 400V



		Amper	Box	Unit
F7.0137	Screwless Connection Socket 16A 5p	16A	1/8	pcs
F7.0138	Screwless Connection Socket 32A 5p	32A	1/8	pcs

ANGLED PANEL SOCKET STRAIGHT 400V



		Pilot	Amper	Flange [mm]	Box	Unit
F7.0043	Panel Mounted Socket 16A 5p	---	16A	75x75	1/6	pcs
F7.0044	Panel Mounted Socket 32A 5p	---	32A	75x75	1/4	pcs
F7.0102	Panel Mounted Socket 63A 5p	YES	63A	107x112	1/1	pcs
F7.0048	Panel Mounted Socket 125A 5p	YES	125A	120x120	1/1	pcs

PANEL MOUNTED PLUG 400V



		Amper	Pole	Flange [mm]	Box	Unit
F7.0100	Panel Mounted Plug 16A 4p	16A	4	75x75	1/10	pcs
F7.0059	Panel Mounted Plug 16A 5p	16A	5	75x75	1/8	pcs
F7.0101	Panel Mounted Plug 32A 4p	32A	4	75x75	1/8	pcs
F7.0060	Panel Mounted Plug 32A 5p	32A	5	75x75	1/8	pcs

PANEL MOUNTED PLUG 400V

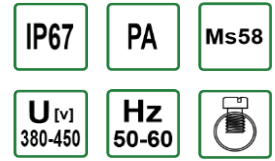

		Pilot	Amper	Flange [mm]	Box	Unit
F7.0063	Panel Mounted Plug 16A 5p	---	16A	83x94	1/6	pcs
F7.0064	Panel Mounted Plug 32A 5p	---	32A	83x94	1/6	pcs
F7.0065	Panel Mounted Plug 63A 5p	YES	63A	107x112	1/1	pcs
F7.0130	Panel Mounted Plug 125A 5p	YES	125A	120x120	1/1	pcs
F7.0085	Watertight cover for angled Surface Plug 16/5				1/1	pcs
F7.0086	Watertight cover for angled Surface Plug 32/5				1/1	pcs
F7.0087	Watertight cover for angled Surface Plug 63/5				1/1	pcs
F7.0136	Watertight cover for angled Surface Plug 125/5				1/1	pcs

ANGLED SURFACE PLUG 400V

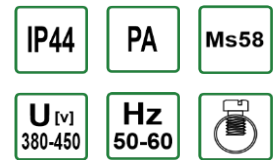

		Amper	Pole	Box	Unit
F7.0097	Angled Surface Plug 16A 4p	16A	4	1/6	pcs
F7.0054	Angled Surface Plug 16A 5p	16A	5	1/3	pcs
F7.0098	Angled Surface Plug 32A 4p	32A	4	1/3	pcs
F7.0055	Angled Surface Plug 32A 5p	32A	5	1/3	pcs
F7.0093	Protective cover for angled Surface Plug 16/4			1/1	pcs
F7.0094	Protective cover for angled Surface Plug 16/5			1/1	pcs
F7.0095	Protective cover for angled Surface Plug 32/5 32/4 32/3			1/1	pcs

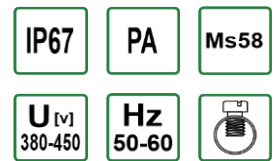

		Pilot	Amper	Box	Unit
F7.0056	Angled Surface Plug 16A 5p	---	16A	1/3	pcs
F7.0057	Angled Surface Plug 32A 5p	---	32A	1/3	pcs
F7.0058	Angled Surface Plug 63A 5p	YES	63A	1/1	pcs
F7.0131	Angled Surface Plug 125A 5p	YES	125A	1/1	pcs
F7.0085	Watertight cover for angled Surface Plug 16/5			1/1	pcs
F7.0086	Watertight cover for angled Surface Plug 32/5			1/1	pcs
F7.0087	Watertight cover for angled Surface Plug 63/5			1/1	pcs
F7.0136	Watertight cover for angled Surface Plug 125/5			1/1	pcs

PANEL SWITCHES 3-PHASE



IP65

		Switch	Flange dimensions	Box	Unit
F3.1085	Panel closing switch 16A 3P yellow-red	0-1	48x48 mm	1/1	pcs
F3.1089	Panel closing switch 32A 3P yellow-red	0-1	64x64 mm	1/1	pcs
F3.1086	Panel closing switch 16A 3P yellow-red	left-right	48x48 mm	1/1	pcs
F3.1090	Panel closing switch 32A 3P yellow-red	left-right	64x64 mm	1/1	pcs



IP65

		Switch	Flange dimensions	Box	Unit
F3.0200	Switch panel 16A 3P	0-1	48x48 mm	1/1	pcs
F3.0475	Switch panel 25A 3P	0-1	64x64 mm	1/1	pcs
F3.0202	Switch panel 32A 3P	0-1	64x64 mm	1/1	pcs
F3.0262	Switch panel 63A 3P	0-1	64x64 mm	1/1	pcs
F3.0201	Switch panel 16A 3P	left-right	48x48 mm	1/1	pcs
F3.0476	Switch panel 25A 3P	left-right	64x64 mm	1/1	pcs
F3.0203	Switch panel 32A 3P	left-right	64x64 mm	1/1	pcs
F3.0263	Switch panel 63A 3P	left-right	64x64 mm	1/1	pcs



ABS

		Cased dimensions	Box	Unit
F3.2616	Case for switch panel 16A left-right, 0-1	66x66x70 mm	1/1	pcs
F3.2617	Case for switch panel 32A left-right, 0-1	110x110x107 mm	1/1	pcs

CASED SWITCHES 3-PHASE



IP65

		Switch	Cased dimensions	Box	Unit
F3.0204	Cased switch 16A 3P	0-1	69x69x95 mm	1/1	pcs
F3.0477	Cased switch 25A 3P	0-1	114x114x140 mm	1/1	pcs
F3.0206	Cased switch 32A 3P	0-1	114x114x140 mm	1/1	pcs
F3.0260	Cased switch 63A 3P	0-1	114x114x140 mm	1/1	pcs
F3.0205	Cased switch 16A 3P	left-right	69x69x95 mm	1/1	pcs
F3.0478	Cased switch 25A 3P	left-right	114x114x140 mm	1/1	pcs
F3.0207	Cased switch 32A 3P	left-right	114x114x140 mm	1/1	pcs



IP65

U [V]
400



Hz
50-60



		Switch	Cased dimensions	Box	Unit
F3.2200	Cased switch WS-20 20A	0-1	100x79x100 mm	1/1	pcs
F3.2201	Cased switch WS-25 25A	0-1	125x100x120 mm	1/1	pcs
F3.2202	Cased switch WS-32 32A	0-1	125x100x120 mm	1/1	pcs



IP65

U [V]
400



Hz
50-60



		Switch	Cased dimensions	Box	Unit
F3.2203	Cased switch WS-40 40A	0-1	176x115x135 mm	1/1	pcs
F3.2204	Cased switch WS-63 63A	0-1	240x159x164 mm	1/1	pcs
F3.2205	Cased switch WS-100 100A	0-1	240x159x164 mm	1/1	pcs

TERMINALS HLS



NEW

IP20

PA

Al
Cu

U_I [V]
1000

U_I [V]
400

TH35

		Input wire	Output wire	Box	Unit
F2.0518	Terminal HLS 100A-2 - black	1x25,1x16mm ²	1x25,1x16mm ²	1/20	pcs
F2.0519	Terminal HLS 100A-2 - brown	1x25,1x16mm ²	1x25,1x16mm ²	1/20	pcs
F2.0520	Terminal HLS 100A-2 - grey	1x25,1x16mm ²	1x25,1x16mm ²	1/20	pcs
F2.0521	Terminal HLS 100A-2 - blue	1x25,1x16mm ²	1x25,1x16mm ²	1/20	pcs
F2.0522	Terminal HLS 100A-2 - green	1x25,1x16mm ²	1x25,1x16mm ²	1/20	pcs
F2.0523	Terminal HLS 125A-2 - black	1x35,1x25mm ²	1x35,1x25mm ²	1/20	pcs
F2.0524	Terminal HLS 125A-2 - brown	1x35,1x25mm ²	1x35,1x25mm ²	1/20	pcs
F2.0525	Terminal HLS 125A-2 - grey	1x35,1x25mm ²	1x35,1x25mm ²	1/20	pcs
F2.0526	Terminal HLS 125A-2 - blue	1x35,1x25mm ²	1x35,1x25mm ²	1/20	pcs
F2.0527	Terminal HLS 125A-2 - green	1x35,1x25mm ²	1x35,1x25mm ²	1/20	pcs



NEW

IP20

PA

Al
Cu

U_I [V]
1000

U_I [V]
400

TH35

		Input wire	Output wire	Box	Unit
F2.0528	Terminal HLS 3x100A-2 (3L)	1x25,1x16mm ²	1x25,1x16mm ²	1/6	pcs
F2.0529	Terminal HLS 3x125A-2 (3L)	1x35,1x25mm ²	1x35,1x25mm ²	1/6	pcs



NEW

IP20

PA

Al
Cu

U_I [V]
1000

U_I [V]
400

TH35

		Input wire	Output wire	Box	Unit
F2.0530	Terminal HLS 5x100A-2 (3L+N+PE)	1x25,1x16mm ²	1x25,1x16mm ²	1/4	pcs
F2.0531	Terminal HLS 5x125A-2 (3L+N+PE)	1x35,1x25mm ²	1x35,1x25mm ²	1/4	pcs

We hereby inform that the terminals HLS are marketed worldwide, with the exception of the German market.

TERMINALS HLK

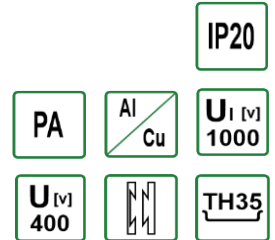

		Input wire	Output wire	Box	Unit
F2.0355	Terminal HLK 100A-2 - black	1x25,1x16mm ²	1x25,1x16mm ²	1/20	pcs
F2.0356	Terminal HLK 100A-2 - brown	1x25,1x16mm ²	1x25,1x16mm ²	1/20	pcs
F2.0357	Terminal HLK 100A-2 - grey	1x25,1x16mm ²	1x25,1x16mm ²	1/20	pcs
F2.0358	Terminal HLK 100A-2 - blue	1x25,1x16mm ²	1x25,1x16mm ²	1/20	pcs
F2.0359	Terminal HLK 100A-2 - green	1x25,1x16mm ²	1x25,1x16mm ²	1/20	pcs
F2.0370	Terminal HLK 125A-2 - black	1x35,1x25mm ²	1x35,1x25mm ²	1/20	pcs
F2.0371	Terminal HLK 125A-2 - brown	1x35,1x25mm ²	1x35,1x25mm ²	1/20	pcs
F2.0372	Terminal HLK 125A-2 - grey	1x35,1x25mm ²	1x35,1x25mm ²	1/20	pcs
F2.0373	Terminal HLK 125A-2 - blue	1x35,1x25mm ²	1x35,1x25mm ²	1/20	pcs
F2.0374	Terminal HLK 125A-2 - green	1x35,1x25mm ²	1x35,1x25mm ²	1/20	pcs

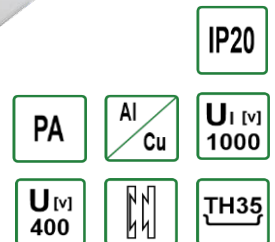

		Input wire	Output wire	Box	Unit
F2.0360	Terminal HLK 100A-3 - black	1x25,2x16mm ²	1x25,2x16mm ²	1/14	pcs
F2.0361	Terminal HLK 100A-3 - brown	1x25,2x16mm ²	1x25,2x16mm ²	1/14	pcs
F2.0362	Terminal HLK 100A-3 - grey	1x25,2x16mm ²	1x25,2x16mm ²	1/14	pcs
F2.0363	Terminal HLK 100A-3 - blue	1x25,2x16mm ²	1x25,2x16mm ²	1/14	pcs
F2.0364	Terminal HLK 100A-3 - green	1x25,2x16mm ²	1x25,2x16mm ²	1/14	pcs
F2.0375	Terminal HLK 125A-3 - black	1x35,2x25mm ²	1x35,2x25mm ²	1/16	pcs
F2.0376	Terminal HLK 125A-3 - brown	1x35,2x25mm ²	1x35,2x25mm ²	1/16	pcs
F2.0377	Terminal HLK 125A-3 - grey	1x35,2x25mm ²	1x35,2x25mm ²	1/16	pcs
F2.0378	Terminal HLK 125A-3 - blue	1x35,2x25mm ²	1x35,2x25mm ²	1/16	pcs
F2.0379	Terminal HLK 125A-3 - green	1x35,2x25mm ²	1x35,2x25mm ²	1/16	pcs

We hereby inform that the terminals HLS are marketed worldwide, with the exception of the German market.

TERMINALS HLK



		Input wire	Output wire	Box	Unit
F2.0365	Terminal HLK 100A-4 - black	1x25,3x16mm ²	1x25,3x16mm ²	1/12	pcs
F2.0366	Terminal HLK 100A-4 - brown	1x25,3x16mm ²	1x25,3x16mm ²	1/12	pcs
F2.0367	Terminal HLK 100A-4 - grey	1x25,3x16mm ²	1x25,3x16mm ²	1/12	pcs
F2.0368	Terminal HLK 100A-4 - blue	1x25,3x16mm ²	1x25,3x16mm ²	1/12	pcs
F2.0369	Terminal HLK 100A-4 - green	1x25,3x16mm ²	1x25,3x16mm ²	1/12	pcs
F2.0380	Terminal HLK 125A-4 - black	1x35,3x25mm ²	1x35,3x25mm ²	1/12	pcs
F2.0381	Terminal HLK 125A-4 - brown	1x35,3x25mm ²	1x35,3x25mm ²	1/12	pcs
F2.0382	Terminal HLK 125A-4 - grey	1x35,3x25mm ²	1x35,3x25mm ²	1/12	pcs
F2.0383	Terminal HLK 125A-4 - blue	1x35,3x25mm ²	1x35,3x25mm ²	1/12	pcs
F2.0384	Terminal HLK 125A-4 - green	1x35,3x25mm ²	1x35,3x25mm ²	1/12	pcs

IP20

PA

Al / Cu

U_I [V] 1000

U_I [V] 400

TH35



		Input wire	Output wire	Box	Unit
F2.0385	Terminal HLK 3x100A-2 (3L)	1x25,1x16mm ²	1x25,1x16mm ²	1/8	pcs
F2.0386	Terminal HLK 3x125A-2 (3L)	1x35,1x25mm ²	1x35,1x25mm ²	1/8	pcs

IP20

PA

Al / Cu

U_I [V] 1000

U_I [V] 400

TH35



		Input wire	Output wire	Box	Unit
F2.0387	Terminal HLK 5x100A-2 (3L+N+PE)	1x25,1x16mm ²	1x25,1x16mm ²	1/5	pcs
F2.0388	Terminal HLK 5x125A-2 (3L+N+PE)	1x35,1x25mm ²	1x35,1x25mm ²	1/4	pcs

IP20

PA

Al / Cu

U_I [V] 1000

U_I [V] 400

TH35

TERMINAL STRIP IN HOUSING



Clamp material: tin-plated aluminum

		I [A] Cu/Al	Mounting	Box	Unit
F2.0230	Terminal strips with body (ZU 1-way) 1,5 - 16 mm ² - blue	85A/75A	TH35	1/20	pcs
F2.0231	Terminal strips with body (ZU 1-way) 1,5 - 16 mm ² - grey	85A/75A	TH35	1/20	pcs
F2.0232	Terminal strips with body (ZU 1-way) 1,5 - 16 mm ² - yellow/green	85A/75A	TH35	1/20	pcs



Clamp material: tin-plated aluminum

		I [A] Cu/Al	Mounting	Box	Unit
F2.0279	Terminal strips with body (ZU 1-way) 2,5 - 35 mm ² - blue	135A/120A	TH35	1/10	pcs
F2.0280	Terminal strips with body (ZU 1-way) 2,5 - 35 mm ² - grey	135A/120A	TH35	1/10	pcs
F2.0281	Terminal strips with body (ZU 1-way) 2,5 - 35 mm ² - yellow/green	135A/120A	TH35	1/10	pcs



Clamp material: tin-plated aluminum

		I [A] Cu/Al	Mounting	Box	Unit
F2.0120	Terminal strips with body (ZU 1-way) 2,5 - 50 mm ² - blue	160A/145A	TH35	1/10	pcs
F2.0121	Terminal strips with body (ZU 1-way) 2,5 - 50 mm ² - grey	160A/145A	TH35	1/10	pcs
F2.0125	Terminal strips with body (ZU 1-way) 2,5 - 50 mm ² - yellow/green	160A/145A	TH35	1/10	pcs



Clamp material: tin-plated aluminum

		I [A] Cu/Al	Mounting	Box	Unit
F2.0282	Terminal strips with body (ZU 1-way) 16 - 95 mm ² - blue	245A/220A	DIN rail/screw	1/8	pcs
F2.0283	Terminal strips with body (ZU 1-way) 16 - 95 mm ² - grey	245A/220A	DIN rail/screw	1/8	pcs
F2.0284	Terminal strips with body (ZU 1-way) 16 - 95 mm ² - yellow/green	245A/220A	DIN rail/screw	1/8	pcs



Clamp material: tin-plated aluminum

		I [A] Cu/Al	Mounting	Box	Unit
F2.0285	Terminal strips with body (ZU 1-way) 35 - 150 mm ² - blue	320A/290A	DIN rail/screw	1/5	pcs
F2.0286	Terminal strips with body (ZU 1-way) 35 - 150 mm ² - grey	320A/290A	DIN rail/screw	1/5	pcs
F2.0287	Terminal strips with body (ZU 1-way) 35 - 150 mm ² - yellow/green	320A/290A	DIN rail/screw	1/5	pcs

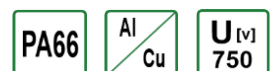

Clamp material: tin-plated aluminum

		I [A] Cu/Al	Mounting	Box	Unit
F2.0288	Terminal strips with body (ZU 1-way) 35 - 240 mm ² - blue	425A/380A	screw	1/2	pcs
F2.0289	Terminal strips with body (ZU 1-way) 35 - 240 mm ² - grey	425A/380A	screw	1/2	pcs
F2.0290	Terminal strips with body (ZU 1-way) 35 - 240 mm ² - yellow/green	425A/380A	screw	1/2	pcs

TERMINAL STRIP IN HOUSING



PA66 $\frac{Al}{Cu}$ U_[V] 750

Clamp material: tin-plated aluminum

		I [A] Cu/Al	Mounting	Box	Unit
F2.0535	Terminal strips with body (ZU 1-way) 2x16 / 2x16 mm ² - blue	85A/75A	DIN rail	1/10	pcs
F2.0536	Terminal strips with body (ZU 1-way) 2x16 / 2x16 mm ² - grey	85A/75A	DIN rail	1/10	pcs
F2.0537	Terminal strips with body (ZU 1-way) 2x16 / 2x16 mm ² - yellow/green	85A/75A	DIN rail	1/10	pcs



PA66 $\frac{Al}{Cu}$ U_[V] 750

Clamp material: tin-plated aluminum

		I [A] Cu/Al	Mounting	Box	Unit
F2.0291	Terminal strips with body (ZU 1-way) 2x35 / 2x35 mm ² - blue	135A/120A	DIN rail	1/6	pcs
F2.0293	Terminal strips with body (ZU 1-way) 2x35 / 2x35 mm ² - grey	135A/120A	DIN rail	1/6	pcs
F2.0292	Terminal strips with body (ZU 1-way) 2x35 / 2x35 mm ² - yellow/green	135A/120A	DIN rail	1/6	pcs



PA66 $\frac{Al}{Cu}$ U_[V] 750

Clamp material: tin-plated aluminum

		I [A] Cu/Al	Mounting	Box	Unit
F2.0294	Terminal strips with body (ZU 1-way) 2x50 / 2x50 mm ² - blue	160A/145A	DIN rail	1/6	pcs
F2.0295	Terminal strips with body (ZU 1-way) 2x50 / 2x50 mm ² - grey	160A/145A	DIN rail	1/6	pcs
F2.0296	Terminal strips with body (ZU 1-way) 2x50 / 2x50 mm ² - yellow/green	160A/145A	DIN rail	1/6	pcs



PA66 $\frac{Al}{Cu}$ U_[V] 750

Clamp material: tin-plated aluminum

		I [A] Cu/Al	Mounting	Box	Unit
F2.0297	Terminal strips with body (ZU 1-way) 2x95 / 2x95 mm ² - blue	245A/220A	DIN rail/screw	1/3	pcs
F2.0298	Terminal strips with body (ZU 1-way) 2x95 / 2x95 mm ² - grey	245A/220A	DIN rail/screw	1/3	pcs
F2.0299	Terminal strips with body (ZU 1-way) 2x95 / 2x95 mm ² - yellow/green	245A/220A	DIN rail/screw	1/3	pcs



PA66 $\frac{Al}{Cu}$ U_[V] 750

Clamp material: tin-plated aluminum

		I [A] Cu/Al	Mounting	Box	Unit
F2.0300	Terminal strips with body (ZU 1-way) 2x150 / 2x150 mm ² - blue	320A/290A	DIN rail/screw	1/2	pcs
F2.0301	Terminal strips with body (ZU 1-way) 2x150 / 2x150 mm ² - grey	320A/290A	DIN rail/screw	1/2	pcs
F2.0302	Terminal strips with body (ZU 1-way) 2x150 / 2x150 mm ² - yellow/gre	320A/290A	DIN rail/screw	1/2	pcs
F2.0303	Terminal strips with body (ZU 1-way) 2x240 / 2x240 mm ² - blue	425A/380A	screw	1/1	pcs
F2.0304	Terminal strips with body (ZU 1-way) 2x240 / 2x240 mm ² - grey	425A/380A	screw	1/1	pcs
F2.0305	Terminal strips with body (ZU 1-way) 2x240 / 2x240 mm ² - yellow/gre	425A/380A	screw	1/1	pcs

TERMINAL STRIP IN HOUSING



PA66 $\frac{Al}{Cu}$ U_[V] 750

Clamp material: tin-plated aluminum

		I [A] Cu/Al	Mounting	Box	Unit
F2.0316	Terminal strips with body (ZU 1-way) 3x50 / 3x50 mm ² - blue		DIN rail	1/5	pcs
F2.0317	Terminal strips with body (ZU 1-way) 3x50 / 3x50 mm ² - grey		DIN rail	1/5	pcs
F2.0318	Terminal strips with body (ZU 1-way) 3x50 / 3x50 mm ² - yellow/green		DIN rail	1/5	pcs
F2.0319	Terminal strips with body (ZU 1-way) 3x95 / 3x95 mm ² - blue		DIN rail/screw	1/3	pcs
F2.0320	Terminal strips with body (ZU 1-way) 3x95 / 3x95 mm ² - grey		DIN rail/screw	1/3	pcs
F2.0321	Terminal strips with body (ZU 1-way) 3x95 / 3x95 mm ² - yellow/green		DIN rail/screw	1/3	pcs



PA66 $\frac{Al}{Cu}$ U_[V] 750

Clamp material: tin-plated aluminum

		I [A] Cu/Al	Mounting	Box	Unit
F2.0322	Terminal strips with body (ZU 1-way) 3x150 / 3x150 mm ² - blue		DIN rail/screw	1/3	pcs
F2.0323	Terminal strips with body (ZU 1-way) 3x150 / 3x150 mm ² - grey		DIN rail/screw	1/3	pcs
F2.0324	Terminal strips with body (ZU 1-way) 3x150 / 3x150 mm ² - yellow/green		DIN rail/screw	1/3	pcs
F2.0325	Terminal strips with body (ZU 1-way) 3x240 / 3x240 mm ² - blue		screw	1/1	pcs
F2.0326	Terminal strips with body (ZU 1-way) 3x240 / 3x240 mm ² - grey		screw	1/1	pcs
F2.0327	Terminal strips with body (ZU 1-way) 3x240 / 3x240 mm ² - yellow/green		screw	1/1	pcs



PA66 $\frac{Al}{Cu}$ U_[V] 750

Clamp material: tin-plated aluminum

		U _[V]	I [A] Cu/Al	Mounting	Box	Unit
F2.0538	Terminal strips with body (ZU 3-way) 3x16 mm ² (3L)	690V	85A/75A	DIN rail	1/8	pcs
F2.0539	Terminal strips with body (ZU 3-way) 3x35 mm ² (3L)	750V	135A/120A	DIN rail	1/5	pcs
F2.0306	Terminal strips with body (ZU 3-way) 3x50 mm ² (3L)	750V	160A/145A	DIN rail	1/5	pcs
F2.0540	Terminal strips with body (ZU 5-way) 5x16 mm ² (3L+N+PE)	690V	85A/75A	DIN rail/screw	1/4	pcs
F2.0307	Terminal strips with body (ZU 5-way) 5x35 mm ² (3L+N+PE)	750V	135A/120A	DIN rail/screw	1/4	pcs
F2.0308	Terminal strips with body (ZU 5-way) 5x50 mm ² (3L+N+PE)	750V	160A/145A	DIN rail/screw	1/4	pcs

ACCESSORIES



PA66

		Box	Unit
F2.0541	Protection cover for terminal strips ZU - 16mm ²	1/10	pcs
F2.0542	Protection cover for terminal strips ZU - 35mm ²	1/10	pcs
F2.0543	Protection cover for terminal strips ZU - 50mm ²	1/10	pcs
F2.0544	Protection cover for terminal strips ZU - 95mm ²	1/10	pcs
F2.0545	Protection cover for terminal strips ZU - 150mm ²	1/10	pcs
F2.0546	Protection cover for terminal strips ZU - 240mm ²	1/10	pcs

TERMINAL BLOCKS LKN



Clamp material: nickel-plated brass

		Input wire	Output wire	Box	Unit
F2.0331	Terminal blocks LKN 80A blue	3x16mm ²	4x6 mm ²	1/10	pcs
F2.0332	Terminal blocks LKN 80A grey	3x16mm ²	4x6 mm ²	1/10	pcs
F2.0333	Terminal blocks LKN 80A yellow	3x16mm ²	4x6 mm ²	1/10	pcs



Clamp material: nickel-plated brass

		Input wire	Output wire	Box	Unit
F2.0334	Terminal blocks LKN 125A blue	1x35,1x16mm ²	6x16 mm ²	1/10	pcs
F2.0335	Terminal blocks LKN 125A grey	1x35,1x16mm ²	6x16 mm ²	1/10	pcs
F2.0336	Terminal blocks LKN 125A yellow	1x35,1x16mm ²	6x16 mm ²	1/10	pcs

F2.0337	Terminal blocks LKN 160A blue	1x70,1x16mm ²	6x16 mm ²	1/10	pcs
F2.0338	Terminal blocks LKN 160A grey	1x70,1x16mm ²	6x16 mm ²	1/10	pcs
F2.0339	Terminal blocks LKN 160A yellow	1x70,1x16mm ²	6x16 mm ²	1/10	pcs

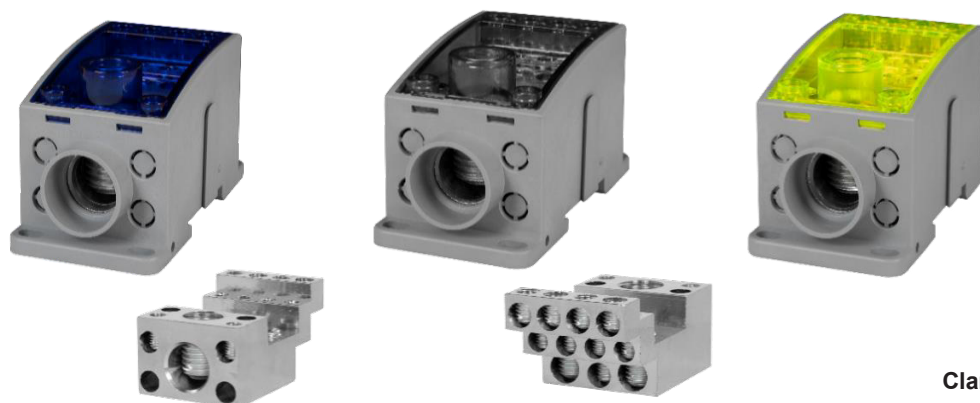

Clamp material: nickel-plated brass

		Input wire	Output wire	Box	Unit
F2.0340	Terminal blocks LKN 250A blue	1x120,4x16 mm ²	2x35,1x25,4x16,4x10 mm ²	1/6	pcs
F2.0341	Terminal blocks LKN 250A grey	1x120,4x16 mm ²	2x35,1x25,4x16,4x10 mm ²	1/6	pcs
F2.0342	Terminal blocks LKN 250A yellow	1x120,4x16 mm ²	2x35,1x25,4x16,4x10 mm ²	1/6	pcs

F2.0343	Terminal blocks LKN 400A blue	1x185,4x16 mm ²	2x35,1x25,4x16,4x10 mm ²	1/6	pcs
F2.0344	Terminal blocks LKN 400A grey	1x185,4x16 mm ²	2x35,1x25,4x16,4x10 mm ²	1/6	pcs
F2.0345	Terminal blocks LKN 400A yellow	1x185,4x16 mm ²	2x35,1x25,4x16,4x10 mm ²	1/6	pcs

TERMINAL BLOCKS DBR



Clamp material: tin-plated brass

		Input wire	Output wire	I [A]	Box	Unit
F2.0547	Terminal blocks DBR 100A black	2x25 mm ²	6x10 mm ²	100A	1/10	pcs
F2.0548	Terminal blocks DBR 100A brown	2x25 mm ²	6x10 mm ²	100A	1/10	pcs
F2.0549	Terminal blocks DBR 100A grey	2x25 mm ²	6x10 mm ²	100A	1/10	pcs
F2.0550	Terminal blocks DBR 100A blue	2x25 mm ²	6x10 mm ²	100A	1/10	pcs
F2.0551	Terminal blocks DBR 100A green	2x25 mm ²	6x10 mm ²	100A	1/10	pcs



Clamp material: tin-plated brass

		Input wire	Output wire	I [A]	Box	Unit
F2.0552	Terminal blocks DBR 200A black	1x70, 1x35 mm ²	6x16 mm ²	200A	1/5	pcs
F2.0553	Terminal blocks DBR 200A brown	1x70, 1x35 mm ²	6x16 mm ³	200A	1/5	pcs
F2.0554	Terminal blocks DBR 200A grey	1x70, 1x35 mm ²	6x16 mm ⁴	200A	1/5	pcs
F2.0555	Terminal blocks DBR 200A blue	1x70, 1x35 mm ²	6x16 mm ⁵	200A	1/5	pcs
F2.0556	Terminal blocks DBR 200A green	1x70, 1x35 mm ²	6x16 mm ⁶	200A	1/5	pcs

TERMINAL BLOCKS LBR



IP20	PA
CuZn	U _[M] 500
	TH35

		I _[A]	Holes	Box	Unit
F2.0161	Terminal blocks bipolar LBR - 207	100A	2x7	1/1	pcs
F2.0162	Terminal blocks bipolar LBR - 211	125A	2x11	1/1	pcs
F2.0163	Terminal blocks bipolar LBR - 215	125A	2x15	1/1	pcs



IP20	PA
CuZn	U _[M] 500
	TH35

		I _[A]	Holes	Box	Unit
F2.0043	Terminal blocks quadripolar LBR - 407	100A	4x7	1/1	pcs
F2.0044	Terminal blocks quadripolar LBR - 411	125A	4x11	1/1	pcs
F2.0045	Terminal blocks quadripolar LBR - 415	125A	4x15	1/1	pcs

CURRENT PROTECTION TERMINALS ZPI



IP20	PA
CuZn	U _[M] 690
	I _[A] 63
Al	16 [mm ²]
TH35	

		Color	Diameter of holes	Quantity of holes	Box	Unit
F2.0389	Current protection terminal ZPI 7 borehole 7x16mm ²	blue	ø 5,5 mm	7	1/10	pcs
F2.0391	Current protection terminal ZPI 12 borehole 12x16mm ²	blue	ø 5,5 mm	12	1/10	pcs
F2.0393	Current protection terminal ZPI 15 borehole 15x16mm ²	blue	ø 5,5 mm	15	1/10	pcs



IP20	PA
CuZn	U _[M] 690
	I _[A] 63
Al	16 [mm ²]
TH35	

		Color	Diameter of holes	Quantity of holes	Box	Unit
F2.0390	Current protection terminal ZPI 7 borehole 7x16mm ²	yellow/green	ø 5,5 mm	7	1/10	pcs
F2.0392	Current protection terminal ZPI 12 borehole 12x16mm ²	yellow/green	ø 5,5 mm	12	1/10	pcs
F2.0394	Current protection terminal ZPI 15 borehole 15x16mm ²	yellow/green	ø 5,5 mm	15	1/10	pcs

INSULATED MAIN TERMINALS IP20

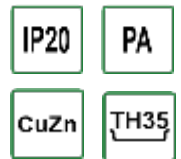

		Color	Diameter of holes	Quantity of holes	Box	Unit
F2.0256	Insulated main terminal 7 borehole 7x16mm ²	blue	ø 5,3 mm	7	1/10	pcs
F2.0258	Insulated main terminal 12 borehole 12x16mm ²	blue	ø 5,3 mm	12	1/10	pcs
F2.0260	Insulated main terminal 15 borehole 15x16mm ²	blue	ø 5,3 mm	15	1/10	pcs

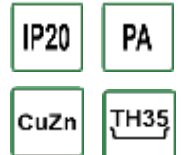

		Color	Diameter of holes	Quantity of holes	Box	Unit
F2.0257	Insulated main terminal 7 borehole 7x16mm ²	green	ø 5,3 mm	7	1/10	pcs
F2.0259	Insulated main terminal 12 borehole 12x16mm ²	green	ø 5,3 mm	12	1/10	pcs
F2.0261	Insulated main terminal 15 borehole 15x16mm ²	green	ø 5,3 mm	15	1/10	pcs

INSULATED MAIN TERMINALS IP20

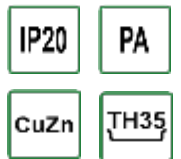

		Color	Diameter of holes	Quantity of holes	Box	Unit
F2.0264	Insulated main terminal 7 borehole 7x16mm ²	grey	ø 5,3 mm	7	1/10	pcs
F2.0265	Insulated main terminal 12 borehole 12x16mm ²	grey	ø 5,3 mm	12	1/10	pcs

INSULATED MAIN TERMINALS

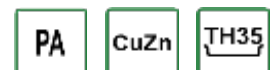

		Color	Diameter of holes	Quantity of holes	Box	Unit
F2.0114	Insulated main terminal 7 borehole 7x16mm ²	blue	ø 5,3 mm	7	1/10	pcs
F2.0116	Insulated main terminal 12 borehole 12x16mm ²	blue	ø 5,3 mm	12	1/10	pcs
F2.0118	Insulated main terminal 15 borehole 15x16mm ²	blue	ø 5,3 mm	15	1/10	pcs

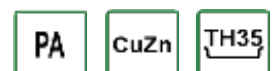
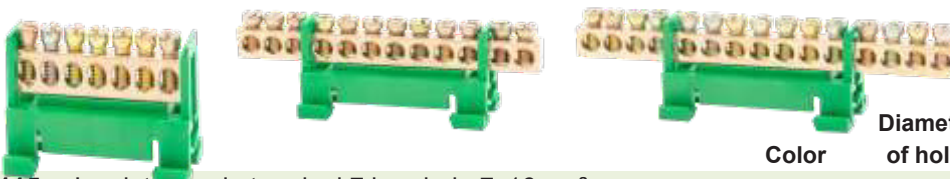

		Color	Diameter of holes	Quantity of holes	Box	Unit
F2.0115	Insulated main terminal 7 borehole 7x16mm ²	green	ø 5,3 mm	7	1/10	pcs
F2.0117	Insulated main terminal 12 borehole 12x16mm ²	green	ø 5,3 mm	12	1/10	pcs
F2.0119	Insulated main terminal 15 borehole 15x16mm ²	green	ø 5,3 mm	15	1/10	pcs

TERMINAL STRIPS - HIGH BASE

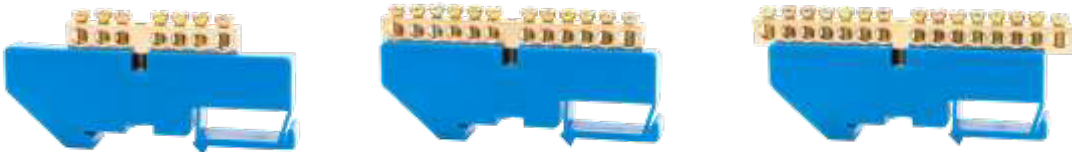

		PA	CuZn		
		U [M]	16 [mm ²]	TH35	
		600			
		Diameter of holes	Quantity of holes	Box	Unit
F2.0059	Terminal strips 7 borehole 7x16mm ²	blue	ø 5,2 mm	7	1/10 pcs
F2.0067	Terminal strips 12 borehole 12x16mm ²	blue	ø 5,2 mm	12	1/10 pcs
F2.0069	Terminal strips 15 borehole 15x16mm ²	blue	ø 5,2 mm	15	1/10 pcs



		PA	CuZn		
		U [M]	16 [mm ²]	TH35	
		600			
		Diameter of holes	Quantity of holes	Box	Unit
F2.0057	Terminal strips 2x5 borehole 2x5x16mm ²	blue	ø 5,2 mm	2x5	1/10 pcs
F2.0065	Terminal strips 11 borehole 11x16mm ² , 1x35mm ²	blue	ø 5,2 mm	12	1/10 pcs
F2.0071	Terminal strips 18 borehole 18x16mm ² , 1x35mm ²	blue	ø 5,2 mm	19	1/10 pcs



		PA	CuZn		
		U [M]	16 [mm ²]	TH35	
		600			
		Diameter of holes	Quantity of holes	Box	Unit
F2.0060	Terminal strips 7 borehole 7x16mm ²	yellow	ø 5,2 mm	7	1/10 pcs
F2.0068	Terminal strips 12 borehole 12x16mm ²	yellow	ø 5,2 mm	12	1/10 pcs
F2.0070	Terminal strips 15 borehole 15x16mm ²	yellow	ø 5,2 mm	15	1/10 pcs



		PA	CuZn		
		U [M]	16 [mm ²]	TH35	
		600			
		Diameter of holes	Quantity of holes	Box	Unit
F2.0058	Terminal strips 2x5 borehole 2x5x16mm ²	yellow	ø 5,2 mm	2x5	1/10 pcs
F2.0066	Terminal strips 11 borehole 11x16mm ² , 1x35mm ²	yellow	ø 5,2 mm	12	1/10 pcs
F2.0072	Terminal strips 18 borehole 18x16mm ² , 1x35mm ²	yellow	ø 5,2 mm	19	1/10 pcs

TERMINAL STRIPS



		CuZn	U [M]	16 [mm ²]		
			690			
		Diameter of holes	Quantity of holes	Box	Unit	
F2.0262	Terminal strips 142x16mm ² - 1m	ø 5,3 mm	142	1/1	pcs	
F2.0350	Terminal strips 5x16mm ²	ø 5,6 mm	5	1/1	pcs	

EQUIPOTENTIAL BUSBARS



PA

		Possibility connecting	Box	Unit
F2.0112	Equipotential busbar 7x25 mm ² , 1x50 mm ² , rectifier 30x4 mm	screw / TH35	1/1	pcs
F2.0329	Equipotential busbar 7x25 mm ² , 1x50 mm ² , rectifier 30x4 mm	screw	1/100	pcs
F2.0113	Equipotential busbar 5x6 mm ² , 1x25 mm ²	screw	1/10	pcs



16 [mm²]

Clamp material: galvanized steel
Clip materia: stainless steel

		Diameter pipes	Range pipe diameter	Belt lenght [mm]	Belt width [mm]	Box	Unit
F2.0107	Earthing clip OU1	ø 8 - 22	1/8-3/8"	120	14	1/10	pcs
F2.0108	Earthing clip OU2	ø 8 - 50	1/8-1,5"	190	20	1/10	pcs
F2.0109	Earthing clip OU3	ø 8 - 114	1/8-4"	410	20	1/10	pcs
F2.0110	Earthing clip OU4	ø 8 - 165	1/8-6"	550	20	1/10	pcs

PROTECTIVE CONNECTORS



PA U_[M] 690 I_[A] 76
CuZn TH35

		Color	Box	Unit
F2.0046	Protective connector 2x35 mm ²	blue	1/10	pcs
F2.0048	Protective connector oczkowy 2xM8	blue	1/10	pcs
F2.0050	Protective connector 1x25/4x10 mm ²	blue	1/10	pcs



PA U_[M] 690 I_[A] 76
CuZn TH35

		Color	Box	Unit
F2.0047	Protective connector 2x35 mm ²	yellow/green	1/10	pcs
F2.0049	Protective connector oczkowy 2xM8	yellow/green	1/10	pcs
F2.0051	Protective connector 1x25/4x10 mm ²	yellow/green	1/10	pcs

TERMETERINAL RAIL TH



STEEL galvanized 35x7,5 [mm]

		Box	Unit
F6.0349	Termeterinal rail TH 35 - 0,25m	1/4	pcs
F6.0348	Termeterinal rail TH 35 - 0,50m	1/2	pcs
F6.0001	Termeterinal rail TH 35 - 1m	1/10	pcs
F6.0351	Termeterinal rail TH 35 perforated - 0,25m	1/4	pcs
F6.0350	Termeterinal rail TH 35 perforated - 0,50m	1/2	pcs
F6.0009	Termeterinal rail TH 35 perforated - 1m	1/10	pcs
F6.0030	Termeterinal rail TH 35 perforated - 2m	1/10	pcs

WIRE CONNECTOR



PC UL 94 V-2	U _[V] 450	I _[A] 32
11mm	0,5-2,5 [mm ²]	40°C

		Possibility connecting	Dimensions [mm]	Box	Unit
F2.0073	Wire connector 2,5 mm ² - 2 pin	single core	16,7x10x5,8	1/100	pcs
F2.0074	Wire connector 2,5 mm ² - 3 pin	single core	16,7x14x5,8	1/100	pcs
F2.0075	Wire connector 2,5 mm ² - 4 pin	single core	16,7x18x5,8	1/100	pcs
F2.0076	Wire connector 2,5 mm ² - 5 pin	single core	16,7x22x5,8	1/100	pcs
F2.0077	Wire connector 2,5 mm ² - 8 pin	single core	16,7x18x14	1/50	pcs



PC UL 94 V-2	U _[V] 450	I _[A] 32
11mm	0,2-4 [mm ²]	40°C

		Possibility connecting	Dimensions [mm]	Box	Unit
F2.0275	Wire connector 0,14-4mm ² - 2 pin	single core / multi core	19,4x13x9,6	1/100	pcs
F2.0276	Wire connector 0,14-4mm ² - 3 pin	single core / multi core	19,4x18,6x9,6	1/100	pcs
F2.0277	Wire connector 0,14-4mm ² - 4 pin	single core / multi core	19,4x24,2x9,6	1/100	pcs
F2.0278	Wire connector 0,14-4mm ² - 5 pin	single core / multi core	19,4x29,8x9,6	1/100	pcs

TERMINAL STRIPS 12 WAY



PE	U _[V] 400
----	-------------------------

		I _[A]	Box	Unit
F2.0179	Terminal strips 12 way 2,5 mm ² orange	3A	1/10	pcs
F2.0180	Terminal strips 12 way 4 mm ² orange	6A	1/10	pcs
F2.0181	Terminal strips 12 way 6 mm ² orange	10A	1/10	pcs
F2.0182	Terminal strips 12 way 10 mm ² orange	15A	1/10	pcs
F2.0183	Terminal strips 12 way 16 mm ² orange	30A	1/10	pcs

TERMINAL STRIPS RHOMBUS



U _[V] 380

U _[V] 400

Clamp material: galvanized steel

		U _[V]	Material	Mounting	Box	Unit
F2.0173	Terminal strips 4x2,5 mm ²	380V		screw	1/50	pcs
F2.0174	Terminal strips 5x2,5 mm ²	380V		screw	1/50	pcs
F2.0100	Terminal strips 4x4 mm ²	380V		screw	1/50	pcs
F2.0101	Terminal strips 5x4 mm ²	380V		screw	1/50	pcs
F2.0034	Terminal strips 4x10 mm ²	400V	polycarbonate	screw	1/25	pcs
F2.0035	Terminal strips 5x10 mm ²	400V	polycarbonate	screw	1/25	pcs
F2.0036	Terminal strips 4x16 mm ²	400V	polyamide	screw	1/10	pcs
F2.0037	Terminal strips 5x16 mm ²	400V	polyamide	screw	1/10	pcs

TERMINAL STRIPS MULTI-WAY



Clamp material:
tin-plated aluminum

		I [A]	Mounting	Box	Unit
F2.0216	Terminal strips LZW 5x16 mm ² Cu/Al	82A	DIN rail/screw	1/1	pcs
F2.0217	Terminal strips LZW 5x35 mm ² Cu/Al	125A	DIN rail/screw	1/1	pcs
F2.0218	Terminal strips LZW 5x50 mm ² Cu/Al	160A	DIN rail/screw	1/1	pcs



Clamp material:
tin-plated aluminum

		I [A]	Mounting	Box	Unit
F2.0219	Terminal strips LZW 5x16 mm ² Cu/Al + cover	82A	DIN rail/screw	1/1	pcs
F2.0220	Terminal strips LZW 5x35 mm ² Cu/Al + cover	125A	DIN rail/screw	1/1	pcs
F2.0221	Terminal strips LZW 5x50 mm ² Cu/Al + cover	160A	DIN rail/screw	1/1	pcs

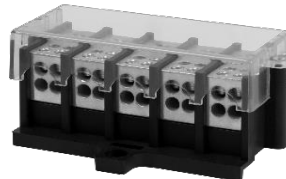

Clamp material:
tin-plated aluminum

		I [A]	Mounting	Box	Unit
F2.0273	Terminal strips LZW 5x35 / 4x10 mm ² Cu/Al	125A / 41A	DIN rail/screw	1/1	pcs
F2.0274	Terminal strips LZW 5x35 / 4x10 mm ² Cu/Al + cover	125A / 41A	DIN rail/screw	1/1	pcs
F2.0347	Cover for terminal strips LZW			1/1	pcs



		Mounting	Box	Unit
F2.0038	Terminal strips LZ 4x35 mm ²	screw	1/5	pcs
F2.0039	Terminal strips LZ 5x35 mm ²	screw	1/5	pcs

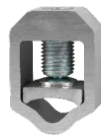
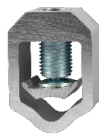

		Material	Box	Unit
F2.0126	Terminal V-clamp 25 - 120SW	aluminium	1/1	pcs
F2.0127	Terminal V-clamp 35 - 240SW	aluminium	1/1	pcs
F2.0128	Terminal V-clamp 70 - 300SW	aluminium	1/1	pcs
F2.0164	Terminal V-clamp 35 - 240SW double	aluminium	1/1	pcs
F2.0129	Plate V-clamp 25 - 120SW	tin-plated copper	1/1	pcs
F2.0130	Plate V-clamp 35 - 240SW	tin-plated copper	1/1	pcs

TERMINAL STRIPS



PA	Cu
----	----

		U [V]	I [A]	Mounting	Box	Unit
F2.0001	Terminal strips LZ 1x35 / 4x6 mm ²	500V	125A / 41A	DIN rail	1/32	pcs
F2.0270	Terminal strips LZ 1x35 / 4x6 mm ² + cover	500V	125A / 41A	DIN rail	1/32	pcs



PA	U [V] 690	I [A] 232/125
----	--------------	------------------

Clamp material: tin plated copper

		Mounting	Box	Unit
F2.0007	Terminal strips LZ 1x95 / 4x35 mm ² - grey	DIN rail/screw	1/18	pcs
F2.0131	Terminal strips LZ 1x95 / 4x35 mm ² - blue	DIN rail/screw	1/18	pcs
F2.0132	Terminal strips LZ 1x95 / 4x35 mm ² - yellow/green	DIN rail/screw	1/18	pcs



PA PC	U [V] 500	I [A] 125/41
----------	--------------	-----------------

Clamp material: copper

		Mounting	Box	Unit
F2.0019	Terminal strips LZ 4x35 / 16x6 mm ² + cover	DIN rail/screw	1/8	pcs



PA PS	U [V] 650	I [A] 125/76
----------	--------------	-----------------

Clamp material: copper

		Mounting	Box	Unit
F2.0030	Terminal strips LZ 5x35 / 20x16 mm ² + cover	screw	1/5	pcs
F2.0032	Terminal strips LZ 5x35 / 20x16 mm ² + cover	DIN rail	1/5	pcs

TERMINAL BLOCKS



PA	CuZn
----	------

U [V] 500	I [A] 60	TH35
--------------	-------------	------

		Box	Unit
F2.0123	Terminal blocks unipolar 60A - 35 / 6x6 mm ² - blue	1/1	pcs
F2.0122	Terminal blocks unipolar 60A - 35 / 6x6 mm ² - grey	1/1	pcs
F2.0124	Terminal blocks unipolar 60A - 35 / 6x6 mm ² - yellow/green	1/1	pcs

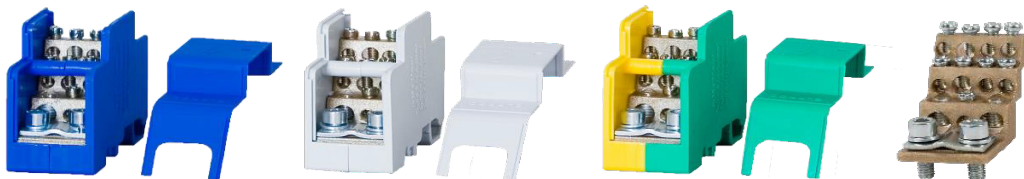

PA	CuZn
----	------

U [V] 500	I [A] 160	TH35
--------------	--------------	------

		Box	Unit
F2.0041	Terminal blocks unipolar 160A - 70 / 2x25,2x16,7x6 mm ² - blue	1/1	pcs
F2.0040	Terminal blocks unipolar 160A - 70 / 2x25,2x16,7x6 mm ² - grey	1/1	pcs
F2.0042	Terminal blocks unipolar 160A - 70 / 2x25,2x16,7x6 mm ² - yellow/green	1/1	pcs

TERMINAL STRIP IN HOUSING



Clamp material:
tin-plated aluminum

		I [A]	Mounting	Box	Unit
F2.0195	Terminal strips with body 2x16 / 2x16 mm ² - blue	82A	DIN rail	1/20	pcs
F2.0196	Terminal strips with body 2x16 / 2x16 mm ² - grey	82A	DIN rail	1/20	pcs
F2.0197	Terminal strips with body 2x16 / 2x16 mm ² - yellow/green	82A	DIN rail	1/20	pcs
F2.0138	Terminal strips with body 2x35 / 2x35 mm ² - blue	125A	DIN rail	1/10	pcs
F2.0133	Terminal strips with body 2x35 / 2x35 mm ² - grey	125A	DIN rail	1/10	pcs
F2.0139	Terminal strips with body 2x35 / 2x35 mm ² - yellow/green	125A	DIN rail	1/10	pcs

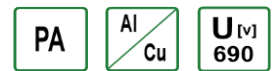

Clamp material:
tin-plated aluminum

		I [A]	Mounting	Box	Unit
F2.0247	Terminal strips with body 1x35 / 2x16 mm ² - blue	125A/82A	DIN rail	1/20	pcs
F2.0248	Terminal strips with body 1x35 / 2x16 mm ² - grey	125A/82A	DIN rail	1/20	pcs
F2.0249	Terminal strips with body 1x35 / 2x16 mm ² - yellow/green	125A/82A	DIN rail	1/20	pcs
F2.0135	Terminal strips with body 1x95 / 2x35 mm ² - blue	245A/125A	DIN rail	1/10	pcs
F2.0134	Terminal strips with body 1x95 / 2x35 mm ² - grey	245A/125A	DIN rail	1/10	pcs
F2.0141	Terminal strips with body 1x95 / 2x35 mm ² - yellow/green	245A/125A	DIN rail	1/10	pcs

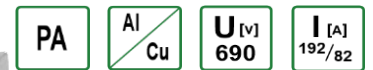

Clamp material:
tin-plated aluminum

		Mounting	Box	Unit
F2.0233	Terminal strips with body 1x70 / 4x16 mm ² - blue	DIN rail	1/10	pcs
F2.0234	Terminal strips with body 1x70 / 4x16 mm ² - grey	DIN rail	1/10	pcs
F2.0235	Terminal strips with body 1x70 / 4x16 mm ² - yellow/green	DIN rail	1/10	pcs

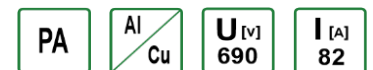

Clamp material:
tin-plated aluminum

		Mounting	Box	Unit
F2.0236	Terminal strips with body 4x16 / 4x16 mm ² - blue	DIN rail	1/10	pcs
F2.0237	Terminal strips with body 4x16 / 4x16 mm ² - grey	DIN rail	1/10	pcs
F2.0238	Terminal strips with body 4x16 / 4x16 mm ² - yellow/green	DIN rail	1/10	pcs

FORK BUSBARS 1P

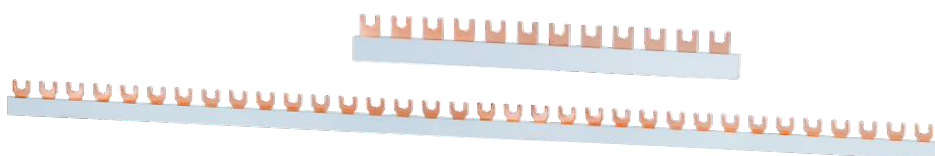

		$I_{[A]}$	Box	Unit
F2.0078	Fork busbar 1P S-12, 10mm ²	63A	1/40	pcs
F2.0083	Fork busbar 1P S-12, 12mm ²	80A	1/40	pcs
F2.0089	Fork busbar 1P S-12, 16mm ²	100A	1/40	pcs
F2.0079	Fork busbar 1P S-54, 10mm ²	63A	1/40	pcs
F2.0084	Fork busbar 1P S-54, 12mm ²	80A	1/40	pcs
F2.0090	Fork busbar 1P S-54, 16mm ²	100A	1/40	pcs

FORK BUSBARS 3P

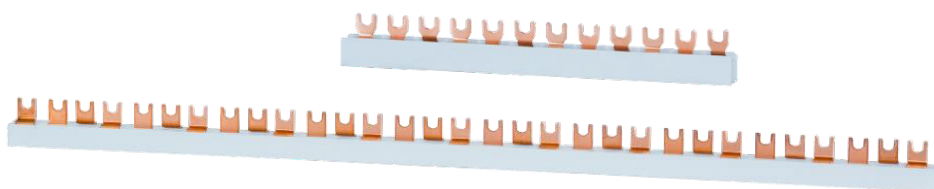

		$I_{[A]}$	Box	Unit
F2.0346	Fork busbar 3P S-9, 10mm ²	63A	1/20	pcs
F2.0085	Fork busbar 3P S-9, 12mm ²	80A	1/20	pcs
F2.0080	Fork busbar 3P S-12, 10mm ²	63A	1/20	pcs
F2.0086	Fork busbar 3P S-12, 12mm ²	80A	1/20	pcs
F2.0091	Fork busbar 3P S-12, 16mm ²	100A	1/20	pcs
F2.0094	Fork busbar 3P S-12, 16mm ² , divide insulation	100A	1/20	pcs
F2.0081	Fork busbar 3P S-18, 10mm ²	63A	1/20	pcs
F2.0087	Fork busbar 3P S-18, 12mm ²	80A	1/20	pcs
F2.0092	Fork busbar 3P S-18, 16mm ²	100A	1/20	pcs
F2.0095	Fork busbar 3P S-18, 16mm ² , divide insulation	100A	1/20	pcs
F2.0082	Fork busbar 3P S-54, 10mm ²	63A	1/20	pcs
F2.0088	Fork busbar 3P S-54, 12mm ²	80A	1/20	pcs
F2.0093	Fork busbar 3P S-54, 16mm ²	100A	1/20	pcs
F2.0096	Fork busbar 3P S-54, 16mm ² , divide insulation	100A	1/20	pcs

END COVER FOR BUSBARS



		Box	Unit
F2.0309	End cover for busbars 1P/10	1/25	pcs
F2.0310	End cover for busbars 1P/12	1/25	pcs
F2.0311	End cover for busbars 1P/16	1/25	pcs
F2.0312	End cover for busbars 3P/10	1/25	pcs
F2.0313	End cover for busbars 3P/12	1/25	pcs
F2.0314	End cover for busbars 3P/16	1/25	pcs
F2.0315	End cover for busbars 3P/16 divide - 3 pcs	1/25	set

PIN BUSBARS 1F and 3F

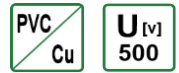
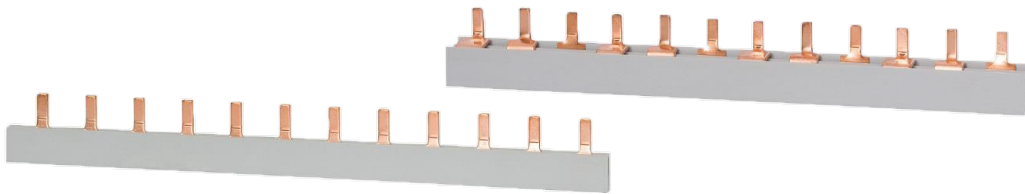

			$I_{[A]}$	Box	Unit
F2.0150	Pin busbar 1P S-12, 10mm ²		63A	1/40	pcs
F2.0154	Pin busbar 1P S-12, 16mm ²		100A	1/40	pcs
F2.0151	Pin busbar 1P S-54, 10mm ²		63A	1/40	pcs
F2.0155	Pin busbar 1P S-54, 16mm ²		100A	1/40	pcs
F2.0152	Pin busbar 3P S-12, 10mm ²		63A	1/20	pcs
F2.0156	Pin busbar 3P S-12, 16mm ²		100A	1/20	pcs
F2.0153	Pin busbar 3P S-54, 10mm ²		63A	1/20	pcs
F2.0157	Pin busbar 3P S-54, 16mm ²		100A	1/20	pcs

FORK BUSBARS 2F and 4F

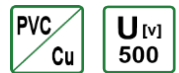
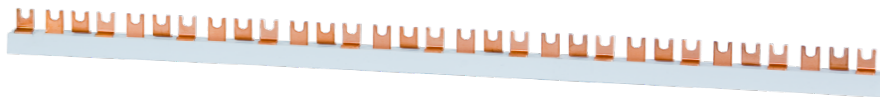

			$I_{[A]}$	Box	Unit
F2.0222	Pork busbar 2P S-54, 16mm ²		100A	1/10	pcs
F2.0223	Pork busbar 4P S-56, 16mm ²		100A	1/10	pcs

PIN BUSBARS 1F and 3F

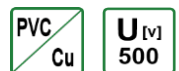
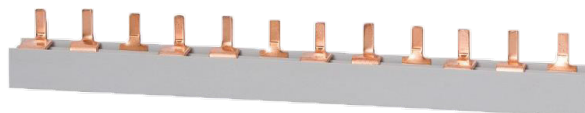

			$I_{[A]}$	Box	Unit
F2.0224	Pin busbar 3P S-36, 16mm ² (mod. 27mm)		100A	1/10	pcs
F2.0269	Pin busbar 1P S-36, 16mm ²		100A	1/10	pcs

PLASTIC PANELS IP65

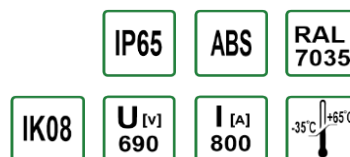

		Equipment	Quantity of locks	Box	Unit
F1.0255	Plastic panel 180x240x130 mm	mounting plate - metal	1	1/1	pcs
F1.0126	Plastic panel 200x300x130 mm	mounting plate - metal	1	1/1	pcs
F1.0326	Plastic panel 210x280x130 mm	mounting plate - metal	1	1/1	pcs
F1.0327	Plastic panel 250x300x130 mm	mounting plate - metal	1	1/1	pcs
F1.0328	Plastic panel 250x330x130 mm	mounting plate - metal	1	1/1	pcs
F1.0121	Plastic panel 250x350x150 mm	mounting plate - metal	2	1/1	pcs
F1.0256	Plastic panel 300x350x165 mm	mounting plate - metal	1	1/1	pcs
F1.0122	Plastic panel 300x400x170 mm	mounting plate - metal	2	1/1	pcs
F1.0329	Plastic panel 300x400x195 mm	mounting plate - metal	2	1/1	pcs
F1.0152	Plastic panel 300x400x220 mm	mounting plate - metal	2	1/1	pcs
F1.0123	Plastic panel 350x500x190 mm	mounting plate - metal	2	1/1	pcs
F1.0163	Plastic panel 400x500x180 mm	mounting plate - metal	2	1/1	pcs
F1.0155	Plastic panel 400x500x240 mm	mounting plate - metal	2	1/1	pcs
F1.0124	Plastic panel 400x600x200 mm	mounting plate - metal	2	1/1	pcs
F1.0330	Plastic panel 500x600x220 mm	mounting plate - metal	2	1/1	pcs
F1.0125	Plastic panel 500x700x250 mm	mounting plate - metal	2	1/1	pcs
F1.0171	Plastic panel 600x800x260 mm	mounting plate - metal	3	1/1	pcs
F1.0257	Plastic panel 750x1000x300 mm	mounting plate - metal	1	1/1	pcs

PLASTIC PANEL - TRANSPARENT DOOR

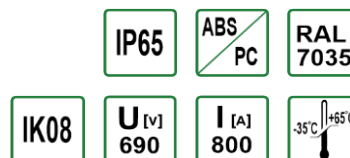

		Equipment	Quantity of locks	Box	Unit
F1.0331	Plastic panel 180x240x130 mm	mounting plate - metal	1	1/1	pcs
F1.0127	Plastic panel 200x300x130 mm	mounting plate - metal	1	1/1	pcs
F1.0319	Plastic panel 210x280x130 mm	mounting plate - metal	1	1/1	pcs
F1.0332	Plastic panel 250x300x130 mm	mounting plate - metal	1	1/1	pcs
F1.0333	Plastic panel 250x330x130 mm	mounting plate - metal	1	1/1	pcs
F1.0128	Plastic panel 250x350x150 mm	mounting plate - metal	2	1/1	pcs
F1.0334	Plastic panel 300x350x165 mm	mounting plate - metal	1	1/1	pcs
F1.0129	Plastic panel 300x400x170 mm	mounting plate - metal	2	1/1	pcs
F1.0335	Plastic panel 300x400x195 mm	mounting plate - metal	2	1/1	pcs
F1.0154	Plastic panel 300x400x220 mm	mounting plate - metal	2	1/1	pcs
F1.0130	Plastic panel 350x500x190 mm	mounting plate - metal	2	1/1	pcs
F1.0164	Plastic panel 400x500x180 mm	mounting plate - metal	2	1/1	pcs
F1.0153	Plastic panel 400x500x240 mm	mounting plate - metal	2	1/1	pcs
F1.0131	Plastic panel 400x600x200 mm	mounting plate - metal	2	1/1	pcs
F1.0336	Plastic panel 500x600x220 mm	mounting plate - metal	2	1/1	pcs
F1.0132	Plastic panel 500x700x250 mm	mounting plate - metal	2	1/1	pcs
F1.0172	Plastic panel 600x800x260 mm	mounting plate - metal	3	1/1	pcs

PLASTIC PANELS WITH MODULES



		Modules	Rows	Box	Unit
F1.0137	Plastic panel 250x350x150 mm	18	2	1/1	pcs
F1.0138	Plastic panel 300x400x170 mm	24	2	1/1	pcs
F1.0139	Plastic panel 350x500x190 mm	45	3	1/1	pcs
F1.0140	Plastic panel 400x600x200 mm	64	4	1/1	pcs

PLASTIC PANEL WITH MODULES - TRANSPARENT DOOR

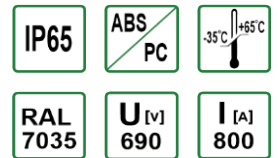

		Modules	Rows	Box	Unit
F1.0141	Plastic panel 250x350x150 mm	18	2	1/1	pcs
F1.0142	Plastic panel 300x400x170 mm	24	2	1/1	pcs
F1.0143	Plastic panel 350x500x190 mm	45	3	1/1	pcs
F1.0144	Plastic panel 400x600x200 mm	64	4	1/1	pcs

SET FOR PLASTIC PANEL



		Modules	Rows	Box	Unit
F1.0148	Set for plastic panel 250x350x150	18	2	1/1	pcs
F1.0149	Set for plastic panel 300x400x170	24	2	1/1	pcs
F1.0150	Set for plastic panel 350x500x190	45	3	1/1	pcs
F1.0151	Set for plastic panel 400x600x200	64	4	1/1	pcs

ACCESSORIES FOR PLASTIC PANEL



		Box	Unit
F1.0258	Plastick key for plastic panel	1/1	pcs
F1.0259	Plastick lock for plastic panel - triangle	1/1	pcs
F1.0133	Plastick lock for plastic panel	1/1	pcs

METAL DISTRIBUTION BOXES



IP66 RAL 7035

U [V] 1000

I [A] 630

± 1,2 mm

Material: powder coated steel

		Equipment	Box	Unit
F1.0174	Metal distribution box 300x200x150 mm	mounting plate - metal	1/1	pcs
F1.0175	Metal distribution box 300x250x150 mm	mounting plate - metal	1/1	pcs
F1.0176	Metal distribution box 300x300x150 mm	mounting plate - metal	1/1	pcs
F1.0177	Metal distribution box 300x300x200 mm	mounting plate - metal	1/1	pcs
F1.0178	Metal distribution box 400x300x150 mm	mounting plate - metal	1/1	pcs
F1.0179	Metal distribution box 400x300x200 mm	mounting plate - metal	1/1	pcs
F1.0180	Metal distribution box 400x400x200 mm	mounting plate - metal	1/1	pcs
F1.0182	Metal distribution box 500x400x200 mm	mounting plate - metal	1/1	pcs
F1.0184	Metal distribution box 600x400x200 mm	mounting plate - metal	1/1	pcs
F1.0185	Metal distribution box 600x400x250 mm	mounting plate - metal	1/1	pcs
F1.0191	Metal distribution box 600x600x200 mm	mounting plate - metal	1/1	pcs
F1.0192	Metal distribution box 600x600x250 mm	mounting plate - metal	1/1	pcs
F1.0194	Metal distribution box 800x600x250 mm	mounting plate - metal	1/1	pcs

METAL DISTRIBUTION BOXES WITH MODULES



IP66 RAL 7035

U [V] 1000

I [A] 630

± 1,2 mm

Material: powder coated steel

		Modules	Rows	Box	Unit
F1.0211	Metal distribution box 500x400x200 mm	45	3	1/1	pcs
F1.0213	Metal distribution box 600x600x250 mm	78	3	1/1	pcs

ACCESSORIES FOR METAL DISTRIBUTION BOXES



F1.0218	Lock for metal distribution box			Box 1/1	Unit pcs
---------	---------------------------------	--	--	---------	----------

SLOTTED CABLE DUCTS

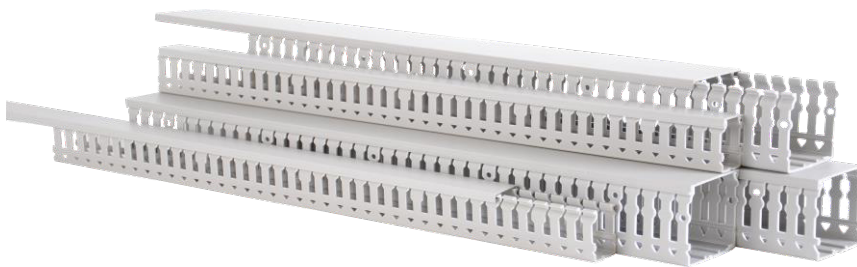

		Length	Box	Unit
F6.0171	Slotted cable duct 25x25 mm /length x height/	2m	120	lm
F6.0078	Slotted cable duct 25x40 mm /length x height/	2m	100	lm
F6.0079	Slotted cable duct 25x60 mm /length x height/	2m	60	lm
F6.0431	Slotted cable duct 25x80 mm /length x height/	2m	48	lm
F6.0080	Slotted cable duct 40x40 mm /length x height/	2m	52	lm
F6.0081	Slotted cable duct 40x60 mm /length x height/	2m	36	lm
F6.0082	Slotted cable duct 40x80 mm /length x height/	2m	40	lm
F6.0168	Slotted cable duct 60x40 mm /length x height/	2m	36	lm
F6.0083	Slotted cable duct 60x60 mm /length x height/	2m	48	lm
F6.0084	Slotted cable duct 60x80 mm /length x height/	2m	36	lm
F6.0085	Slotted cable duct 80x60 mm /length x height/	2m	32	lm
F6.0086	Slotted cable duct 80x80 mm /length x height/	2m	24	lm
F6.0169	Slotted cable duct 100x60 mm /length x height/	2m	24	lm
F6.0170	Slotted cable duct 100x80 mm /length x height/	2m	20	lm

COVER FOR SLOTTED CABLE DUCTS

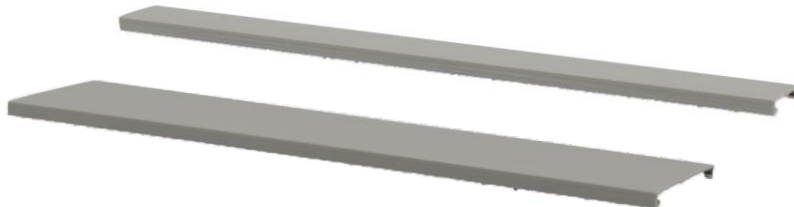

		Length	Box	Unit
F6.0432	Cover for slotted cable duct 25x25 / 25x40 / 25x60 / 25x80	2m	20	lm
F6.0433	Cover for slotted cable duct 40x40 / 40x60 / 40x80	2m	20	lm
F6.0434	Cover for slotted cable duct 80x60 / 80x80	2m	20	lm
F6.0435	Cover for slotted cable duct 80x60 / 80x80	2m	20	lm
F6.0436	Cover for slotted cable duct 100x60 / 100x80	2m	20	lm

VENTILATION SYSTEM



Mounting type: latch

Mounting hole
[mm]

		Mounting hole [mm]	Box	Unit
F6.0091	Fan 120x120mm	91x91	1/1	pcs
F6.0092	Fan 160x160mm	125x125	1/1	pcs
F6.0422	Fan 210x210mm	177x177	1/1	pcs
F6.0093	Fan 260x260mm	223x223	1/1	pcs
F6.0094	Fan 325x325mm	291x291	1/1	pcs



Mounting type: latch

Mounting hole

		Air flow	Power	Mounting hole [mm]	Box	Unit
F6.0095	Filter Fan 120x120mm	30m ³ /h	14W	91x91	1/1	pcs
F6.0096	Filter Fan 160x160mm	100m ³ /h	26W	125x125	1/1	pcs
F6.0423	Filter Fan 210x210mm	125m ³ /h	26W	177x177	1/1	pcs
F6.0424	Filter Fan 210x210mm	175m ³ /h	37W	177x177	1/1	pcs
F6.0097	Filter Fan 260x260mm	115m ³ /h	26W	223x223	1/1	pcs
F6.0098	Filter Fan 260x260mm	240m ³ /h	37W	223x223	1/1	pcs
F6.0099	Filter Fan 260x260mm	650m ³ /h	66W	223x223	1/1	pcs
F6.0100	Filter Fan 325x325mm	850m ³ /h	110W	291x291	1/1	pcs

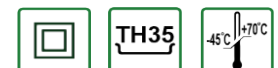

		Box	Unit
F6.0105	Panel Heater PTC 30W	1/1	pcs
F6.0106	Panel Heater PTC 50W	1/1	pcs
F6.0107	Panel Heater PTC 75W	1/1	pcs
F6.0108	Panel Heater PTC 100W	1/1	pcs
F6.0109	Panel Heater PTC 150W	1/1	pcs
F6.0103	Mini Heater PTC 15W with cable 30cm	1/1	pcs
F6.0104	Mini Heater PTC 25W with cable 30cm	1/1	pcs

VENTILATION SYSTEM



		Protection class	Operating range	Box	Unit
				IP20	U _M 230
					TH35
F6.0110	Panel Heater with Fan PTC 100W	II	-45°C +70°C	1/1	pcs
F6.0111	Panel Heater with Fan PTC 150W	II	-45°C +70°C	1/1	pcs
F6.0112	Resistance panel Heater with Fan 250W	I	-25°C +70°C	1/1	pcs
F6.0113	Resistance panel Heater with Fan 500W	I	-25°C +70°C	1/1	pcs
F6.0114	Resistance panel Heater with Fan 750W	I	-25°C +70°C	1/1	pcs



		Sensor type	Maximum current	Setting range	Contact	Box	Unit
						IP20	ABS
						TH35	250V / 120V
F6.0087	Thermostat for heating RED	bimetal	10A	0°C - 60°C	NC	1/1	pcs
F6.0088	Thermostat for cooling BLUE	bimetal	15A	0°C - 60°C	NO	1/1	pcs
F6.0089	Double thermostat	bimetal	10-15A	0°C - 60°C	NC + NO	1/1	pcs

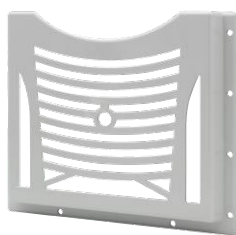

		Box	Unit
		ABS	RAL 7035
		Fixing: adhesive tape / screws	
F6.0120	Drawing Pocket A4 size	1/1	pcs

BUTTON BOXES



		Dimension	Ø holes	Quantity of holes	Box	Unit
09.0001	Button box for single button OS1	69x69x67 mm	22,5	1	1/16	pcs
09.0002	Button Box - emergency push OS1-E	69x69x67 mm	22,5	1	1/16	pcs
09.0003	Button box for double button OS2	109x69x67 mm	22,5	2	1/12	pcs
09.0004	Button box for triple button OS3	164x69x67 mm	22,5	3	1/8	pcs
09.0005	Button box for quad button OS4	202x69x67 mm	22,5	4	1/6	pcs
09.0006	Button box for quintet button OS5	202x69x67 mm	22,5	5	1/6	pcs

LED INDICATOR LIGHTS



Diod type: diffusing mat
Cable length: 300 mm

		U [V]	Power consumption	Mounting diameter	Box	Unit
F4.0059	LED indicator light - diameter 5mm, 230V green	230V AC/DC	0,75W	10 mm	1/10	pcs
F4.0060	LED indicator light - diameter 5mm, 230V yellow	230V AC/DC	0,75W	10 mm	1/10	pcs
F4.0061	LED indicator light - diameter 5mm, 230V red	230V AC/DC	0,75W	10 mm	1/10	pcs
F4.0062	LED indicator light - diameter 5mm, 24V green	12-24 AC/DC	0,75W	10 mm	1/10	pcs
F4.0063	LED indicator light - diameter 5mm, 24V yellow	12-24 AC/DC	0,75W	10 mm	1/10	pcs
F4.0064	LED indicator light - diameter 5mm, 24V red	12-24 AC/DC	0,75W	10 mm	1/10	pcs



Diod type: diffusing mat
Cable length: 300 mm

		U [V]	Power consumption	Mounting diameter	Box	Unit
F4.0065	LED indicator light - diameter 10mm, 230V green	230V AC/DC	0,75W	13 mm	1/10	pcs
F4.0066	LED indicator light - diameter 10mm, 230V yellow	230V AC/DC	0,75W	13 mm	1/10	pcs
F4.0067	LED indicator light - diameter 10mm, 230V red	230V AC/DC	0,75W	13 mm	1/10	pcs
F4.0068	LED indicator light - diameter 10mm, 24V green	12-24 AC/DC	0,75W	13 mm	1/10	pcs
F4.0069	LED indicator light - diameter 10mm, 24V yellow	12-24 AC/DC	0,75W	13 mm	1/10	pcs
F4.0070	LED indicator light - diameter 10mm, 24V red	12-24 AC/DC	0,75W	13 mm	1/10	pcs



Diod type: diffusing mat
Cable length: 300 mm

		U [V]	Power consumption	Mounting diameter	Box	Unit
F4.0071	LED indicator light - diameter 20mm, 230V green	230V AC/DC	1W	13 mm	1/10	pcs
F4.0072	LED indicator light - diameter 20mm, 230V yellow	230V AC/DC	1W	13 mm	1/10	pcs
F4.0073	LED indicator light - diameter 20mm, 230V red	230V AC/DC	1W	13 mm	1/10	pcs
F4.0074	LED indicator light - diameter 20mm, 24V green	12-24 AC/DC	1W	13 mm	1/10	pcs
F4.0075	LED indicator light - diameter 20mm, 24V yellow	12-24 AC/DC	1W	13 mm	1/10	pcs
F4.0076	LED indicator light - diameter 20mm, 24V red	12-24 AC/DC	1W	13 mm	1/10	pcs

RUBBER PLUGS AND SOCKETS



IP44

U [V]
230

I [A]
16

P [W]
3500

		Standard	Box	Unit
F6.0354	Rubber plug NOVA black	uni-schuko	1/30	pcs
F6.0356	Rubber plug NOVA blue	uni-schuko	1/30	pcs
F6.0357	Rubber plug NOVA green	uni-schuko	1/30	pcs
F6.0358	Rubber plug NOVA grey	uni-schuko	1/30	pcs
F6.0359	Rubber plug NOVA orange	uni-schuko	1/30	pcs
F6.0360	Rubber plug NOVA red	uni-schuko	1/30	pcs
F6.0361	Rubber plug NOVA yellow	uni-schuko	1/30	pcs



IP44

U [V]
230

I [A]
16

P [W]
3500

		Plug type	Standard	Op.	J.m.
F6.0368	Rubber socket NOVA black	E	French	1/25	pcs
F6.0475	Rubber socket NOVA green	E	French	1/25	pcs
F6.0476	Rubber socket NOVA blue	E	French	1/25	pcs
F6.0477	Rubber socket NOVA yellow	E	French	1/25	pcs
F6.0478	Rubber socket NOVA orange	E	French	1/25	pcs
F6.0479	Rubber socket NOVA grey	E	French	1/25	pcs
F6.0480	Rubber socket NOVA red	E	French	1/25	pcs
F6.0389	Rubber socket NOVA SCHUKO black	F	SCHUKO	1/25	pcs

RUBBER CONNECTOR



IP54	U ^[V] 230	I ^[A] 16	P ^[W] 3500
------	-------------------------	------------------------	--------------------------

		Plug type	Standard	Box	Unit
F6.0371	Rubber 2 way connector black	E	French	1/8	pcs
F6.0481	Rubber 2 way connector blue	E	French	1/8	pcs
F6.0482	Rubber 2 way connector yellow	E	French	1/8	pcs
F6.0396	Rubber 2 way connector SCHUKO black	F	SCHUKO	1/8	pcs
F6.0399	Rubber 2 way connector SCHUKO blue	F	SCHUKO	1/8	pcs
F6.0400	Rubber 2 way connector SCHUKO yellow	F	SCHUKO	1/8	pcs



IP54	U ^[V] 230	I ^[A] 16	P ^[W] 3500
------	-------------------------	------------------------	--------------------------

		Plug type	Standard	Box	Unit
F6.0372	Rubber 3 way connector black	E	French	1/7	pcs
F6.0483	Rubber 3 way connector green	E	French	1/7	pcs
F6.0484	Rubber 3 way connector blue	E	French	1/7	pcs
F6.0485	Rubber 3 way connector yellow	E	French	1/7	pcs
F6.0486	Rubber 3 way connector pomarańczowa	E	French	1/7	pcs
F6.0487	Rubber 3 way connector grey	E	French	1/7	pcs
F6.0488	Rubber 3 way connector red	E	French	1/7	pcs
F6.0397	Rubber 3 way connector SCHUKO black	F	SCHUKO	1/7	pcs
F6.0401	Rubber 3 way connector SCHUKO blue	F	SCHUKO	1/7	pcs
F6.0402	Rubber 3 way connector SCHUKO yellow	F	SCHUKO	1/7	pcs
F6.0492	Rubber 3 way connector SCHUKO green	F	SCHUKO	1/7	pcs
F6.0493	Rubber 3 way connector SCHUKO pomarańczowa	F	SCHUKO	1/7	pcs
F6.0494	Rubber 3 way connector SCHUKO grey	F	SCHUKO	1/7	pcs
F6.0495	Rubber 3 way connector SCHUKO red	F	SCHUKO	1/7	pcs



IP54	U ^[V] 230	I ^[A] 16	P ^[W] 3500
------	-------------------------	------------------------	--------------------------

		Plug type	Standard	Box	Unit
F6.0373	Rubber 4 way connector black	E	French	1/8	pcs
F6.0490	Rubber 4 way connector blue	E	French	1/8	pcs
F6.0491	Rubber 4 way connector yellow	E	French	1/8	pcs
F6.0398	Rubber 4 way connector SCHUKO black	F	SCHUKO	1/8	pcs
F6.0403	Rubber 4 way connector SCHUKO blue	F	SCHUKO	1/8	pcs
F6.0404	Rubber 4 way connector SCHUKO yellow	F	SCHUKO	1/8	pcs

RUBBER SOCKETS AND PLUGS



IP44		
U [V] 230	I [A] 16	P [W] 3500

		Plug type	Standard	Box	Unit
80052	Rubber plug with a handle	E	French	1/20	pcs
81034	Rubber socket with a handle	E	French	1/20	pcs
81032	Rubber socket with a handle SCHUKO	F	SCHUKO	1/20	pcs



IP44		
U [V] 230	I [A] 16	P [W] 3500

		Standard	Box	Unit
F6.0362	Rubber plug NOVA angular	uni-schuko	1/20	pcs
F6.0363	Rubber plug NOVA angular - long	uni-schuko	1/20	pcs

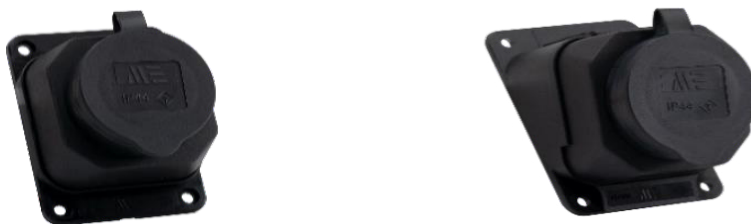

IP44			
U [V] 230	I [A] 16	P [W] 3500	

		Plug type	Standard	Box	Unit
F6.0369	Rubber wall socket - straight	E	French	1/20	pcs
F6.0370	Rubber wall socket - angular	E	French	1/8	pcs

RUBBER CONNECTOR WITH SOCKETS



IP54		
U [V] 230	I [A] 16	P [W] 3500

		Plug type	Standard	Box	Unit
81035	Connector with sockets 3x230V	E	French	1/10	pcs
81033	Connector with sockets 3x230V SCHUKO	F	SCHUKO	1/10	pcs

PLUGS AND SOCKETS FOR HOME USING

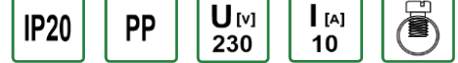

80000 Straight plug 230V white
80001 Straight plug 230V black

Standard	Box	Unit
2P	1/100	pcs
2P	1/100	pcs

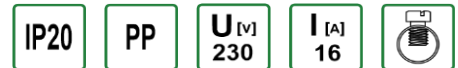

80070 Universal plug (straight and angled) white
80071 Universal plug (straight and angled) black

Standard	Box	Unit
uni-schuko	1/50	pcs
uni-schuko	1/50	pcs

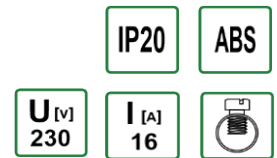

F6.0039 Straight plug with ground 230V white
F6.0037 Angled plug with ground 230V white
F6.0038 Angled plug with ground 230V white uni-schuko
F6.0067 Angled plug with ground 230V black uni-schuko

Standard	Box	Unit
French	1/20	pcs
French	1/20	pcs
uni-schuko	1/20	pcs
uni-schuko	1/20	pcs

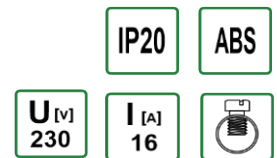

F6.0161 Angled plug 230V with switch
F6.0162 Angled plug 230V with switch and light
F6.0163 Angled plug 230V with socket

Standard	Box	Unit
uni-schuko	1/10	pcs
uni-schuko	1/10	pcs
uni-schuko	1/10	pcs

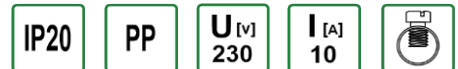

81010 Straight plug 230V - white
81011 Straight plug 230V - black

Box	Unit
1/50	pcs
1/50	pcs

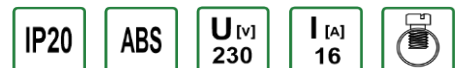

F6.0057 Connector Socket 230V without ground
F6.0058 Connector Socket 230V with ground

Standard	Box	Unit
2P	1/20	pcs
French	1/20	pcs

PLUGS AND SOCKETS FOR INDUSTRIAL USING



PA Ms58

U [V]
220-250

I [A]
16



Protection

		class	Plug type	Standard	Box	Unit
71094	Panel socket 230V - V	IP54	E	French	1/30	pcs
71097	Screwless panel socket 230V	IP44	E	French	1/30	pcs
71098	Screwless panel socket 230V SCHUKO	IP44	F	SCHUKO	1/30	pcs
F6.0033	Panel socket 230V	IP67	E	French	1/24	pcs
F6.0456	Panel socket 230V SCHUKO	IP67	F	SCHUKO	1/24	pcs



IP44

PA

Ms58

U [V]
220-250

I [A]
16



Dimensions

		flange [mm]	Plug type	Standard	Box	Unit
71095	Panel socket 230V - B	50x50	E	French	1/30	pcs
71096	Panel socket 230V - B SCHUKO	50x50	F	SCHUKO	1/30	pcs
71091	Panel socket 230V black - B	50x50	E	French	1/30	pcs
71092	Panel socket 230V black - B SCHUKO	50x50	F	SCHUKO	1/30	pcs
F6.0457	Socket 230V with box	51x61x45	E	French	1/1	pcs
F6.0474	Socket 230V with box SCHUKO	51x61x45	F	SCHUKO	1/1	pcs



IP67

PA

Ms58

U [V]
220-250

I [A]
16



		Plug type	Standard	Box	Unit
F6.0064	Straight Plug 230V		uni-schuko	1/12	pcs
F6.0065	Connector Socket 230V	E	French	1/12	pcs

MODULAR SOCKETS



IP20

PA

U [V]
220-250

I [A]
16

		Plug type	Standard	Box	Unit
F6.0034	Socket 230V for rail TH35	E	French	1/5	pcs
F6.0421	Socket 230V for rail TH35 with control light	E	French	1/12	pcs
F6.0497	Socket 230V for rail TH35 SCHUKO	F	SCHUKO	1/12	pcs

CONNECTING CORD H05RR-F



IP20

U [V]
230I [A]
16OW
H05RR-F

Plug type: straight

Plug type: not demountable

		Length	Box	Unit
F5.0050	Connecting cord OW 2x1,00	1,5m	1/5	pcs
F5.0001	Connecting cord OW 2x1,00	3m	1/5	pcs
F5.0002	Connecting cord OW 2x1,00	5m	1/5	pcs
F5.0051	Connecting cord OW 2x1,50	1,5m	1/5	pcs
F5.0036	Connecting cord OW 2x1,50	3m	1/5	pcs
F5.0037	Connecting cord OW 2x1,50	5m	1/5	pcs



IP20

U [V]
230I [A]
16OW
H05RR-F

Plug type: straight uni-schuko

Plug type: not demountable

		Length	Box	Unit
F5.0056	Connecting cord OW 3x1,00	1,5m	1/5	pcs
F5.0057	Connecting cord OW 3x1,00	3m	1/5	pcs
F5.0058	Connecting cord OW 3x1,00	5m	1/5	pcs
F5.0059	Connecting cord OW 3x1,50	1,5m	1/5	pcs
F5.0060	Connecting cord OW 3x1,50	3m	1/5	pcs
F5.0061	Connecting cord OW 3x1,50	5m	1/5	pcs
F5.0073	Connecting cord OW 3x1,50	10m	1/5	pcs
F5.0048	Connecting cord OW 3x2,50	3m	1/5	pcs
F5.0049	Connecting cord OW 3x2,50	5m	1/5	pcs
F5.0074	Connecting cord OW 3x2,50	10m	1/5	pcs



IP20

U [V]
230I [A]
16OW
H05RR-F

Plug type: angled uni-schuko

Plug type: not demountable

		Length	Box	Unit
F5.0052	Connecting cord OW 3x1,00	1,5m	1/5	pcs
F5.0003	Connecting cord OW 3x1,00	3m	1/5	pcs
F5.0004	Connecting cord OW 3x1,00	5m	1/5	pcs
F5.0053	Connecting cord OW 3x1,50	1,5m	1/5	pcs
F5.0005	Connecting cord OW 3x1,50	3m	1/5	pcs
F5.0006	Connecting cord OW 3x1,50	5m	1/5	pcs

CONNECTING CORD H05VV-F



IP20 U^[V] 230 I^[A] 16 OWY H05VV-F

Plug type: angled uni-schuko
Plug type: not demountable

		Length	Box	Unit
F5.0015	Connecting cord OWY 3x1,00 white	1,5m	1/5	pcs
F5.0016	Connecting cord OWY 3x1,00 white	3m	1/5	pcs
F5.0017	Connecting cord OWY 3x1,00 white	5m	1/5	pcs
F5.0018	Connecting cord OWY 3x1,50 white	1,5m	1/5	pcs
F5.0019	Connecting cord OWY 3x1,50 white	3m	1/5	pcs
F5.0020	Connecting cord OWY 3x1,50 white	5m	1/5	pcs



IP20 U^[V] 230 I^[A] 16 OWY H05VV-F

Plug type: angled uni-schuko
Plug type: not demountable

		Length	Box	Unit
F5.0066	Connecting cord OWY 3x1,00 black	1,5m	1/5	pcs
F5.0067	Connecting cord OWY 3x1,00 black	3m	1/5	pcs
F5.0068	Connecting cord OWY 3x1,00 black	5m	1/5	pcs
F5.0069	Connecting cord OWY 3x1,50 black	1,5m	1/5	pcs
F5.0070	Connecting cord OWY 3x1,50 black	3m	1/5	pcs
F5.0071	Connecting cord OWY 3x1,50 black	5m	1/5	pcs



IP20 U^[V] 230 I^[A] 2,5 H03VV-F

Plug type: straight
Plug type: not demountable



		Length	Box	Unit
F5.0046	Connecting cord OMY 2x0,75 white	2m	1/5	pcs
F5.0047	Connecting cord OMY 2x0,75 black	2m	1/5	pcs



IP20 U^[V] 230 I^[A] 2,5 H03VV-F

Plug type: straight
Plug type: not demountable

		Length	Box	Unit
F5.0031	Connecting cord OMY 2x0,75 with switch - white	2m	1/5	pcs
F5.0034	Connecting cord OMY 2x0,75 with switch - black	2m	1/5	pcs

SPIRAL CONNECTING CORDS

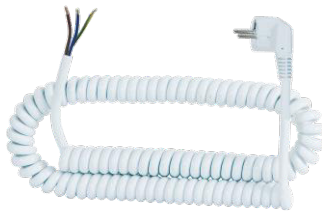

IP20 U_[V] 230 I_[A] 16 H05VVH8-F

Plug type: angled uni-schuko
Plug type: not demountable

		Length	Operating range	Box	Unit
F5.0076	Spiral cord with angled plug 3x1,00 white	3m	350 - 2600 mm	1/1	pcs
F5.0077	Spiral cord with angled plug 3x1,00 white	5m	600 - 4500 mm	1/1	pcs
F5.0078	Spiral cord with angled plug 3x1,00 white	10m	1450 - 9000 mm	1/1	pcs
F5.0079	Spiral cord with angled plug 3x1,50 white	5m	700 - 4200 mm	1/1	pcs



IP20 U_[V] 230 I_[A] 16 H05VVH8-F

Plug type: angled uni-schuko
Plug type: not demountable

		Length	Operating range	Box	Unit
F5.0080	Spiral cord with angled plug 3x1,00 black	3m	350 - 2600 mm	1/1	pcs
F5.0081	Spiral cord with angled plug 3x1,00 black	5m	600 - 4500 mm	1/1	pcs
F5.0082	Spiral cord with angled plug 3x1,00 black	10m	1450 - 9000 mm	1/1	pcs
F5.0083	Spiral cord with angled plug 3x1,50 black	5m	700 - 4200 mm	1/1	pcs

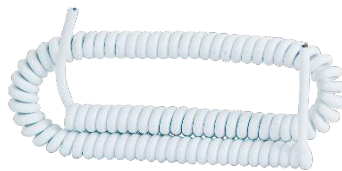

U_[V] 230 I_[A] 16 H05VVH8-F

		Length	Operating range	Box	Unit
F5.0038	Spiral cord 3x1,00 white	3m	350 - 2600 mm	1/1	pcs
F5.0040	Spiral cord 3x1,00 white	5m	600 - 4500 mm	1/1	pcs
F5.0044	Spiral cord 3x1,00 white	10m	1450 - 9000 mm	1/1	pcs
F5.0042	Spiral cord 3x1,50 white	5m	700 - 4200 mm	1/1	pcs
F5.0054	Spiral cord 4x1,00 white	5m	700 - 4400 mm	1/1	pcs



U_[V] 230 I_[A] 16 H05VVH8-F

		Length	Operating range	Box	Unit
F5.0039	Spiral cord 3x1,00 black	3m	350 - 2600 mm	1/1	pcs
F5.0041	Spiral cord 3x1,00 black	5m	600 - 4500 mm	1/1	pcs
F5.0045	Spiral cord 3x1,00 black	10m	1450 - 9000 mm	1/1	pcs
F5.0043	Spiral cord 3x1,50 black	5m	700 - 4200 mm	1/1	pcs
F5.0055	Spiral cord 4x1,00 black	5m	700 - 4400 mm	1/1	pcs

CABLE GLANDS WITH LOCKNUT PG

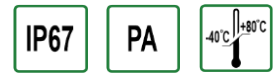

			Color	Thread type	Assembly diameter	Throttling range	Box	Unit
F4.0077	Plastic cable gland	PG-7	grey	PG	12 mm	2 - 7 mm	1/100	pcs
F4.0078	Plastic cable gland	PG-9	grey	PG	15 mm	2 - 8 mm	1/100	pcs
F4.0079	Plastic cable gland	PG-11	grey	PG	18 mm	4 - 11 mm	1/100	pcs
F4.0080	Plastic cable gland	PG-13,5	grey	PG	20 mm	8 - 12 mm	1/100	pcs
F4.0081	Plastic cable gland	PG-16	grey	PG	22 mm	8 - 14 mm	1/100	pcs
F4.0082	Plastic cable gland	PG-21	grey	PG	27 mm	12 - 19 mm	1/100	pcs
F4.0083	Plastic cable gland	PG-29	grey	PG	37 mm	18 - 25 mm	1/100	pcs
F4.0084	Plastic cable gland	PG-36	grey	PG	47 mm	25 - 31 mm	1/20	pcs
F4.0085	Plastic cable gland	PG-42	grey	PG	54 mm	25 - 39 mm	1/20	pcs
F4.0086	Plastic cable gland	PG-48	grey	PG	59 mm	32 - 44 mm	1/20	pcs
F4.0199	Plastic cable gland	PG-63	grey	PG	70 mm	39 - 52 mm	1/1	pcs

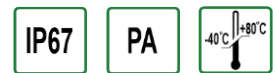

			Color	Thread type	Assembly diameter	Throttling range	Box	Unit
F4.0218	Plastic cable gland	PG-7	black	PG	12 mm	2 - 7 mm	1/100	pcs
F4.0219	Plastic cable gland	PG-9	black	PG	15 mm	2 - 8 mm	1/100	pcs
F4.0220	Plastic cable gland	PG-11	black	PG	18 mm	4 - 11 mm	1/100	pcs
F4.0221	Plastic cable gland	PG-13,5	black	PG	20 mm	8 - 12 mm	1/100	pcs
F4.0222	Plastic cable gland	PG-16	black	PG	22 mm	8 - 14 mm	1/100	pcs
F4.0223	Plastic cable gland	PG-21	black	PG	27 mm	12 - 19 mm	1/100	pcs
F4.0224	Plastic cable gland	PG-29	black	PG	37 mm	18 - 25 mm	1/100	pcs
F4.0225	Plastic cable gland	PG-36	black	PG	47 mm	25 - 31 mm	1/20	pcs
F4.0226	Plastic cable gland	PG-42	black	PG	54 mm	25 - 39 mm	1/20	pcs
F4.0227	Plastic cable gland	PG-48	black	PG	59 mm	32 - 44 mm	1/20	pcs

METRIC CABLE GLANDS WITH LOCKNUT MG

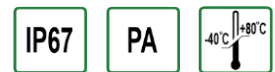

			Color	Thread type	Assembly diameter	Throttling range	Box	Unit
F4.0087	Metric cable gland	MG-12	grey	MG	12 mm	2 - 7 mm	1/100	pcs
F4.0088	Metric cable gland	MG-16	grey	MG	16 mm	2 - 8 mm	1/100	pcs
F4.0089	Metric cable gland	MG-20	grey	MG	20 mm	6 - 12 mm	1/100	pcs
F4.0090	Metric cable gland	MG-25	grey	MG	25 mm	10 - 18 mm	1/100	pcs
F4.0091	Metric cable gland	MG-32	grey	MG	32 mm	13 - 21 mm	1/100	pcs
F4.0092	Metric cable gland	MG-40	grey	MG	40 mm	23 - 33 mm	1/20	pcs
F4.0093	Metric cable gland	MG-50	grey	MG	50 mm	26 - 38 mm	1/20	pcs
F4.0094	Metric cable gland	MG-63	grey	MG	63 mm	32 - 45 mm	1/20	pcs

BRASS METRIC CABLE GLANDS WITH LOCKNUT MG



IP68

		Thread type	Assembly diameter	Throttling range	Box	Unit
F4.0157	Brass metric cable gland MG-12	MG	12 mm	3 - 6,5 mm	1/1	pcs
F4.0158	Brass metric cable gland MG-16	MG	16 mm	3,5 - 8,5 mm	1/1	pcs
F4.0159	Brass metric cable gland MG-20	MG	20 mm	6 - 12 mm	1/1	pcs
F4.0160	Brass metric cable gland MG-25	MG	25 mm	11 - 16 mm	1/1	pcs
F4.0161	Brass metric cable gland MG-32	MG	32 mm	16,5 - 22 mm	1/1	pcs
F4.0162	Brass metric cable gland MG-40	MG	40 mm	22,5 - 30 mm	1/1	pcs
F4.0163	Brass metric cable gland MG-50	MG	50 mm	28 - 38 mm	1/1	pcs
F4.0208	Brass metric cable gland MG-63	MG	63 mm	32 - 40 mm	1/1	pcs

RUBBER CABLE GLANDS BDE



IP30

PP-C



		Assembly diameter	Throttling range	Box	Unit
F4.0175	Rubber cable glands BDE 11	16,5 mm	6 - 8 mm	1/100	pcs
F4.0176	Rubber cable glands BDE 13,5	21 mm	9 - 12 mm	1/100	pcs
F4.0177	Rubber cable glands BDE 16	23 mm	11 - 15 mm	1/100	pcs
F4.0178	Rubber cable glands BDE 21	29 mm	14 - 18 mm	1/50	pcs
F4.0179	Rubber cable glands BDE 29	38 mm	18 - 25 mm	1/30	pcs
F4.0180	Rubber cable glands BDE 36	48 mm	24 - 34 mm	1/20	pcs
F4.0181	Rubber cable glands BDE 42	55 mm	31 - 44 mm	1/10	pcs
F4.0182	Rubber cable glands BDE 48	65 mm	40 - 54 mm	1/10	pcs
F4.0183	Rubber cable glands BDE 54	78 mm	52 - 66 mm	1/10	pcs
F4.0184	Rubber cable glands BDE 67	90 mm	65 - 78 mm	1/10	pcs

HERMETIC BOXES FG WITH GLANDS



		Glands	Box	Unit
F1.0162	Hermetic box FG Ø 65x35 - click	4	1/80	pcs
F1.0058	Hermetic box FG Ø 80x40 - click	4	1/50	pcs
F1.0059	Hermetic box FG 80x80x40 - click	6	1/70	pcs

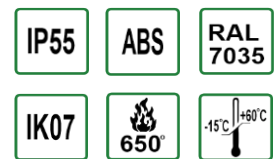

		Cover fixing	Glands	Box	Unit
F1.0060	Hermetic box FG 100x100x50 mm	steel screw	6	1/70	pcs
F1.0061	Hermetic box FG 120x80x50 mm	steel screw	6	1/50	pcs
F1.0062	Hermetic box FG 150x110x70 mm	steel screw	10	1/40	pcs
F1.0098	Hermetic box FG 170x170x75 mm	steel screw	8	1/24	pcs
F1.0099	Hermetic box FG 170x170x127 mm	steel screw	8	1/30	pcs
F1.0063	Hermetic box FG 190x140x70 mm	steel screw	10	1/24	pcs
F1.0064	Hermetic box FG 240x190x90 mm	steel screw	12	1/14	pcs
F1.0065	Hermetic box FG 300x220x120 mm	plastic screw	12	1/6	pcs
F1.0066	Hermetic box FG 380x300x120 mm	plastic screw	12	1/6	pcs
F1.0100	Hermetic box FG 380x300x180 mm	plastic screw	12	1/6	pcs
F1.0067	Hermetic box FG 460x380x120 mm	plastic screw	12	1/8	pcs
F1.0101	Hermetic box FG 460x380x180 mm	plastic screw	12	1/6	pcs

HERMETIC BOXES FG WITHOUT GLANDS

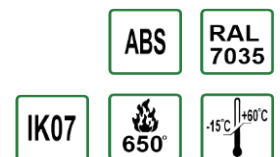

		Cover fixing	Protection class	Box	Unit
F1.0068	Hermetic box FG 100x100x50 mm	steel screw	IP56	1/90	pcs
F1.0069	Hermetic box FG 120x80x50 mm	steel screw	IP56	1/50	pcs
F1.0070	Hermetic box FG 150x110x70 mm	steel screw	IP56	1/50	pcs
F1.0095	Hermetic box FG 170x170x75 mm	steel screw	IP65	1/24	pcs
F1.0071	Hermetic box FG 190x140x70 mm	steel screw	IP56	1/24	pcs
F1.0072	Hermetic box FG 240x190x90 mm	steel screw	IP56	1/14	pcs
F1.0170	Hermetic box FG 240x190x120 mm	steel screw	IP65	1/22	pcs
F1.0073	Hermetic box FG 300x220x120 mm	plastic screw	IP56	1/6	pcs
F1.0120	Hermetic box FG 310x240x120 mm	steel screw	IP65	1/13	pcs
F1.0074	Hermetic box FG 380x300x120 mm	plastic screw	IP56	1/8	pcs
F1.0075	Hermetic box FG 460x380x120 mm	plastic screw	IP65	1/8	pcs

HERMETIC BOXES FG WITHOUT GLANDS



			Box	Unit
F1.0145	Hermetic box FG 180x330x130 mm		1/8	pcs
F1.0146	Hermetic box FG 330x330x130 mm		1/4	pcs
F1.0147	Hermetic box FG 506x330x130 mm		1/1	pcs

HERMETIC BOXES FG WITH HIGH COVER



		Cover fixing	Protection class	Box	Unit
F1.0081	Hermetic box FG 150x110x140 mm	steel screw	IP56	1/16	pcs
F1.0096	Hermetic box FG 170x170x127 mm	steel screw	IP65	1/30	pcs
F1.0082	Hermetic box FG 190x140x140 mm	steel screw	IP56	1/16	pcs
F1.0083	Hermetic box FG 240x190x160 mm	steel screw	IP56	1/8	pcs
F1.0084	Hermetic box FG 300x220x180 mm	plastic screw	IP56	1/4	pcs
F1.0097	Hermetic box FG 380x300x180 mm	plastic screw	IP65	1/6	pcs
F1.0094	Hermetic box FG 460x380x180 mm	plastic screw	IP65	1/8	pcs

HERMETIC BOXES FG WITH TRANSPARENT COVER



		Cover fixing	Protection class	Box	Unit
F1.0089	Hermetic box FG 150x110x70 mm	steel screw	IP56	1/20	pcs
F1.0102	Hermetic box FG 170x170x75 mm	steel screw	IP65	1/24	pcs
F1.0090	Hermetic box FG 190x140x70 mm	steel screw	IP56	1/24	pcs
F1.0091	Hermetic box FG 240x190x90 mm	steel screw	IP56	1/24	pcs
F1.0092	Hermetic box FG 300x220x120 mm	plastic screw	IP56	1/6	pcs
F1.0093	Hermetic box FG 380x300x120 mm	plastic screw	IP65	1/8	pcs
F1.0105	Hermetic box FG 460x380x120 mm	plastic screw	IP65	1/8	pcs

HERMETIC BOXES FG WITH TRANSPARENT COVER



		Cover fixing	Protection class	Box	Unit
F1.0086	Hermetic box FG 150x110x140 mm	steel screw	IP56	1/16	pcs
F1.0103	Hermetic box FG 170x170x127 mm	steel screw	IP65	1/30	pcs
F1.0087	Hermetic box FG 190x140x140 mm	steel screw	IP56	1/16	pcs
F1.0088	Hermetic box FG 240x190x160 mm	steel screw	IP56	1/8	pcs
F1.0104	Hermetic box FG 380x300x180 mm	plastic screw	IP65	1/6	pcs
F1.0106	Hermetic box FG 460x380x180 mm	plastic screw	IP65	1/6	pcs

HERMETIC BOXES BS



		Protection class	Box	Unit
F1.0300	Hermetic box BS 80x45 mm	IP67	1/16	pcs
F1.0223	Hermetic box BS 95x95x60 mm	IP66	1/8	pcs
F1.0298	Hermetic box BS 110x110x70 mm	IP67	1/6	pcs
F1.0224	Hermetic box BS 120x120x100 mm	IP66	1/4	pcs
F1.0225	Hermetic box BS 120x120x70 mm	IP66	1/6	pcs
F1.0299	Hermetic box BS 150x110x70 mm	IP67	1/1	pcs
F1.0227	Hermetic box BS 170x120x70 mm	IP66	1/1	pcs
F1.0229	Hermetic box BS 225x125x80 mm	IP66	1/10	pcs
F1.0231	Hermetic box BS 300x210x90 mm	IP66	1/4	pcs



		Box	Unit
F1.0226	Hermetic box BS 120x120x140 mm	1/1	pcs
F1.0228	Hermetic box BS 170x120x140 mm	1/1	pcs
F1.0230	Hermetic box BS 225x125x140 mm	1/1	pcs
F1.0232	Hermetic box BS 300x225x140 mm	1/1	pcs
F1.0233	Hermetic box BS 340x340x160 mm	1/1	pcs

HERMETIC BOXES BS WITH TRANSPARENT COVER



		Box	Unit
F1.0235	Hermetic box BS 120x120x100 mm	1/4	pcs
F1.0237	Hermetic box BS 170x120x70 mm	1/1	pcs



		Box	Unit
F1.0236	Hermetic box BS 120x120x140 mm	1/1	pcs
F1.0238	Hermetic box BS 170x120x140 mm	1/1	pcs
F1.0239	Hermetic box BS 225x125x140 mm	1/1	pcs
F1.0240	Hermetic box BS 300x225x140 mm	1/1	pcs
F1.0241	Hermetic box BS 340x340x160 mm	1/1	pcs

HERMETIC BOXES CP WITHOUT GLADNS



		Box	Unit
F1.0219	Hermetic box CP 230x130x85 mm	1/16	pcs
F1.0220	Hermetic box CP 350x130x85 mm	1/14	pcs
F1.0221	Hermetic box CP 460x130x85 mm	1/8	pcs

ALUMINIUM BOXES

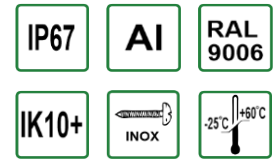

		Box	Unit
F1.0243	Aluminium box 80x80x60 mm	1/1	pcs
F1.0244	Aluminium box 80x80x73 mm	1/1	pcs
F1.0245	Aluminium box 100x100x75 mm	1/1	pcs
F1.0246	Aluminium box 130x80x73 mm	1/1	pcs
F1.0247	Aluminium box 130x130x90 mm	1/1	pcs
F1.0248	Aluminium box 130x190x90 mm	1/1	pcs
F1.0249	Aluminium box 170x80x73 mm	1/1	pcs
F1.0250	Aluminium box 190x170x90 mm	1/1	pcs
F1.0251	Aluminium box 230x80x73 mm	1/1	pcs
F1.0252	Aluminium box 250x190x90 mm	1/1	pcs

HERMETIC BOX WITH CLAMP



		Terminal	Gland	Color	Box	Unit
F1.0112	Hermetic box F11 with clamp - grey	5x4mm ²	4xPG16	RAL7035	1/50	pcs
F1.0173	Hermetic box F11 with clamp - black	5x4mm ²	4xPG16	RAL9017	1/50	pcs
F1.0303	Hermetic box F11 with clamp - brown	5x4mm ²	4xPG16	REL8011	1/50	pcs

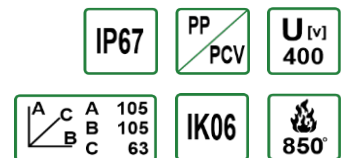

		Terminal	Gland	Color	Box	Unit
F1.0113	Hermetic box 27P with clamp - grey	5x6mm ²	4xPG21	RAL7035	1/20	pcs
F1.0222	Hermetic box 27P with clamp - black	5x6mm ²	4xPG21	RAL9017	1/20	pcs

HEMRETIC BOXES TERMOPLASTIC



Dimensions

		Glands	[mm]	Color	Box	Unit
F1.0260	Hermetic box V8 click - grey	8	80x45x41	RAL7001	1/10	pcs
F1.0262	Hermetic box V8 click - white	8	80x45x41	RAL9003	1/10	pcs
F1.0267	Hermetic box V8 click - brown	8	80x45x41	RAL8007	1/10	pcs
F1.0266	Hermetic box V8 click - black	8	80x45x41	RAL9005	1/10	pcs

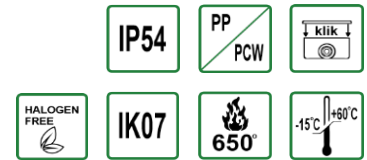

Dimensions

		Glands	[mm]	Color	Box	Unit
F1.0261	Hermetic box V5 click - grey	12	75x75x41	RAL7001	1/10	pcs
F1.0263	Hermetic box V5 click - white	12	75x75x41	RAL9003	1/10	pcs
F1.0269	Hermetic box V5 click - brown	12	75x75x41	RAL8007	1/10	pcs
F1.0268	Hermetic box V5 click - black	12	75x75x41	RAL9005	1/10	pcs
F1.0289	Hermetic box V6 click - grey	12	85x85x41	RAL7001	1/10	pcs
F1.0290	Hermetic box V6 click - white	12	85x85x41	RAL9003	1/10	pcs
F1.0291	Hermetic box V6 click - brown	12	85x85x41	RAL8007	1/10	pcs
F1.0292	Hermetic box V6 click - black	12	85x85x41	RAL9005	1/10	pcs
F1.0293	Hermetic box V7 click - grey	12	100x100x41	RAL7001	1/10	pcs
F1.0294	Hermetic box V7 click - white	12	100x100x41	RAL9003	1/10	pcs
F1.0295	Hermetic box V7 click - brown	12	100x100x41	RAL8007	1/10	pcs
F1.0296	Hermetic box V7 click - black	12	100x100x41	RAL9005	1/10	pcs



Dimensions

		Glands	[mm]	Color	Box	Unit
F1.0134	Hermetic box S1 click - grey	10	90x45x40	RAL7035	1/90	pcs
F1.0135	Hermetic box S2 click - grey	14	90x90x40	RAL7035	1/45	pcs
F1.0136	Hermetic box S3 click - grey	18	90x135x40	RAL7035	1/30	pcs

HEMRETIC BOXES WITH GLANDS

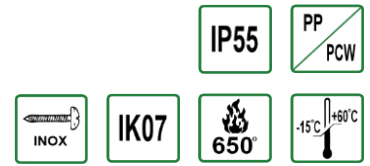

		Glands	Dimensions [mm]	Color	Box	Unit
F1.0306	Hermetic box H55-S - grey	12	85x85x37	RAL7001	1/10	pcs
F1.0307	Hermetic box H55-S - white	12	85x85x37	RAL9003	1/10	pcs
F1.0308	Hermetic box H55-S - brown	12	85x85x37	RAL8007	1/10	pcs
F1.0309	Hermetic box H55-S - black	12	85x85x37	RAL9005	1/10	pcs

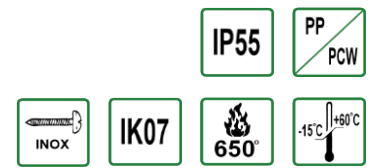

		Glands	Dimensions [mm]	Color	Box	Unit
F1.0310	Hermetic box H55-M - grey	12	98x98x42	RAL7001	1/10	pcs
F1.0311	Hermetic box H55-M - white	12	98x98x42	RAL9003	1/10	pcs
F1.0312	Hermetic box H55-M - brown	12	98x98x42	RAL8007	1/10	pcs
F1.0313	Hermetic box H55-M - black	12	98x98x42	RAL9005	1/10	pcs

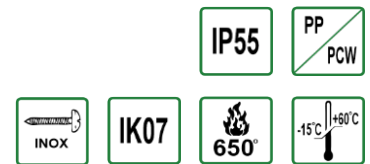

		Glands	Dimensions [mm]	Color	Box	Unit
F1.0314	Hermetic box H55-L - grey	12	118x118x46	RAL7001	1/10	pcs
F1.0315	Hermetic box H55-L - white	12	118x118x46	RAL9003	1/10	pcs
F1.0316	Hermetic box H55-L - brown	12	118x118x46	RAL8007	1/10	pcs
F1.0317	Hermetic box H55-L - black	12	118x118x46	RAL9005	1/10	pcs



		Protection class	Glands	U _[V]	Dimensions [mm]	Box	Unit
F1.0029	Hermetic box P1 empty (P-0)	IP44	4	400V	80x41	1/100	pcs
F1.0031	Hermetic box P2 empty	IP44	4	400V	86x86x36	1/100	pcs
F1.0032	Hermetic box P2 with terminals 4x2,5mm ²	IP44	4	400V	86x86x36	1/100	pcs
F1.0165	Hermetic box P2 empty	IP44	4	400V	86x86x36	1/100	pcs
F1.0078	Hermetic box 85x85mm with terminals	IP44	4	380V	88x88x40	1/50	pcs
F1.0034	Hermetic box PK2	IP41	4	380V	102x102x62	1/24	pcs

INSTALLATION SYSTEMS FOR INSULATED EXTERIOR FACADES



PE-HD

		Fittings range	Box	Unit
1159-60	Telescope equipment carrier	80-200 mm	1/1	pcs
1159-61	Telescope one-gang box	80-200 mm	1/1	pcs

INSTALLATION FLUSH MOUNTING BOXES

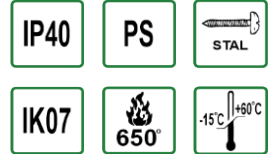

		Box	Unit
F1.0020	Flush mounting boxes 92x92x45 mm	1/129	pcs
F1.0021	Flush mounting boxes 120x100x50 mm	1/83	pcs
F1.0023	Flush mounting boxes 152x100x70 mm	1/47	pcs
F1.0024	Flush mounting boxes 160x130x70 mm	1/36	pcs
F1.0025	Flush mounting boxes 196x152x70 mm	1/25	pcs
F1.0026	Flush mounting boxes 294x152x70 mm	1/25	pcs
F1.0253	Flush mounting boxes 326x294x75 mm	1/8	pcs
F1.0027	Flush mounting boxes 392x152x70 mm	1/16	pcs
F1.0254	Flush mounting boxes 477x294x75 mm	1/5	pcs
F1.0028	Flush mounting boxes 480x160x70 mm	1/12	pcs



		Dimensions [mm]	Box	Unit
F1.0001	Box PK 60	63x45	1/50	pcs
F1.0002	Box PK 60 with screws	63x45	1/50	pcs
F1.0079	Box PK 60 deep	65x65	1/40	pcs
F1.0080	Box PK 60 deep with screws	65x65	1/40	pcs
F1.0006	Box PO 70	75x41	1/50	pcs
F1.0007	Box PO 80	85x48	1/50	pcs

INSTALLATION FLUSH MOUNTING BOXES

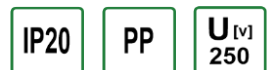

		Dimensions [mm]	Box	Unit
F1.0156	Box PK 60 deep	64x63	1/100	pcs
F1.0157	Box PK 60 deep, with screw	64x63	1/100	pcs
F1.0160	Box PK 60 connection, deep	64x63	1/110	pcs
F1.0161	Box PK 60 connection, deep, with screw	64x63	1/110	pcs

INSTALLATION BOXES FOR GYPSUM WALLS

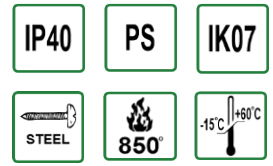
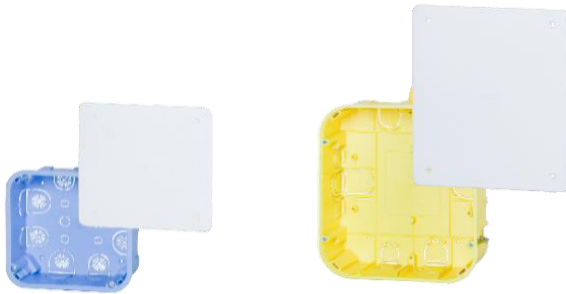

- F1.0110 Box 105x105x50 mm for gypsum walls
- F1.0111 Box 200x165x75 mm for gypsum walls

Box	Unit
1/10	pcs
1/24	pcs



- F1.0008 Box PK 60 for gypsum walls
- F1.0009 Box PK 60 for gypsum walls, deep - possibility of connection
- F1.0013 Box PO 70 for gypsum walls
- F1.0014 Box PO 80 for gypsum walls

Dimensions [mm]	Box	Unit
69x45	1/50	pcs
69x62	1/40	pcs
73x41	1/50	pcs
84x47	1/50	pcs

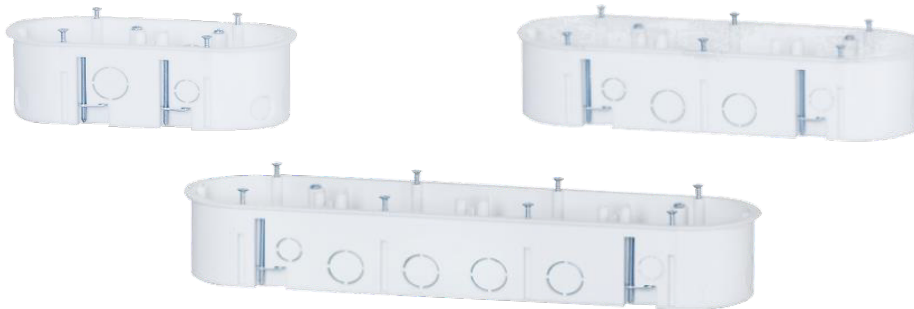

- F1.0010 Box 2x60 for gypsum walls
- F1.0011 Box 3x60 for gypsum walls
- F1.0012 Box 4x60 for gypsum walls

Dimensions [mm]	Box	Unit
138x66x45	1/16	pcs
208x66x45	1/16	pcs
280x66x45	1/16	pcs

AKCESORIA DO PUSZEK



- F1.0017 Cover for box - universal (for flush mounting and gypsum boxes)
- F1.0018 Cover for box PK 60 - red color

Dimensions [mm]	Box	Unit
∅ 89	1/200	pcs
∅ 66	1/100	pcs



- F1.0019 Connection for box PK 60 gypsum, deep

Dimensions [mm]	Box	Unit
21x22x14	1/20	pcs

THERMOPLASTIC LAMP HOLDERS



U^[V]
250

I^[A]
2

M10x1

Material: thermoplastic
Cable fixing: clamp

		Color	Thread type	Box	Unit
F4.0102	Thermoplastic lampholder E14	black	E14	1/50	pcs
F4.0104	Thermoplastic lampholder with ring E14-1	black	E14	1/25	pcs
F4.0103	Thermoplastic lampholder E14	white	E14	1/50	pcs
F4.0105	Thermoplastic lampholder with ring E14-1	white	E14	1/25	pcs



U^[V]
250

I^[A]
4

M10x1

Material: thermoplastic
Cable fixing: clamp

		Color	Thread type	Box	Unit
F4.0106	Thermoplastic lampholder E27-6	black	E27	1/50	pcs
F4.0108	Thermoplastic lampholder with ring E27-1	black	E27	1/25	pcs
F4.0107	Thermoplastic lampholder E27-6	white	E27	1/50	pcs
F4.0109	Thermoplastic lampholder with ring E27-1	white	E27	1/25	pcs



U^[V]
250

I^[A]
4

H03VV-F

2x0,75 [mm²]

Material: thermoplastic

		Color	Cable lenght	Thread type	Box	Unit
F4.0140	Thermoplastic lampholder E27-6 with cable	black	115 mm	E27	1/20	pcs
F4.0230	Thermoplastic lampholder E27-6 with cable and terminal	black	115 mm	E27	1/20	pcs
F4.0139	Thermoplastic lampholder E27-6 with cable	white	115 mm	E27	1/20	pcs
F4.0229	Thermoplastic lampholder E27-6 with cable and terminal	white	115 mm	E27	1/20	pcs

ACCESSORIES FOR LAMP HOLDERS



		Color	Box	Unit
F4.0192	Ring for lampholder E27-1	black	1/1	pcs
F4.0190	Ring for lampholder E14-1	black	1/1	pcs
F4.0191	Ring for lampholder E27-1	white	1/1	pcs
F4.0189	Ring for lampholder E14-1	white	1/1	pcs
F4.0212	Nipple with clamp M10x1 for lampholder E14 / E27	black	1/1	pcs
F4.0211	Nipple with clamp M10x1 for lampholder E14 / E27	white	1/1	pcs
F4.0213	Pendant for lampholder	white	1/1	pcs

THERMOPLASTIC LAMP HOLDERS



ABS U_[V] 250 I_[A] 4

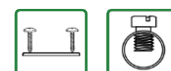

		Color	Thread type	Box	Unit
F4.0134	Straight wall-mounting lampholder - E27	black	E27	1/20	pcs
F4.0133	Straight wall-mounting lampholder - E27	white	E27	1/20	pcs
F4.0136	Angled wall-mounting lampholder - E27	black	E27	1/20	pcs
F4.0135	Angled wall-mounting lampholder - E27	white	E27	1/20	pcs

BAKELITE LAMP HOLDERS



U_[V] 250 M10x1



		I _[A]	Thread type	Box	Unit
F4.0100	Bakelite lampholder E14	2A	E14	1/50	pcs
F4.0101	Bakelite lampholder E27-6	4A	E27	1/50	pcs
F4.0147	Bakelite lampholder - twisted E27-6	4A	E27	1/25	pcs

METALIC LAMP HOLDERS



STAL U_[V] 250 I_[A] 4

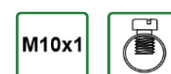

			Thread type	Box	Unit
F4.0110	Metalic lampholder E27		E27	1/10	pcs
F4.0111	Metalic lampholder with ring E27		E27	1/5	pcs

PORCELAIN LAMP HOLDERS



U_[V] 250 I_[A] 4



F4.0112	Porcelain lampholder E27 type 426 with metal handle		E27	1/20	pcs
---------	---	--	-----	------	-----



U_[V] 250

		I _[A]	Thread type	Box	Unit
F4.0113	Porcelain lampholder Z-28, hung up	4A	E27	1/10	pcs
F4.0141	Porcelain lampholder E40	16A	E40	1/80	pcs



62720 Oval light fixtures Panda 60W
62730 Round light fixture Panda 60W

Type	Color	lampshade	Box	Unit
	white	milky	1/1	pcs
	white	milky	1/1	pcs



62740 Oval light fixtures Panda 100W
62750 Round light fixture Panda 100W

Type	Color	lampshade	Box	Unit
	white	milky	1/1	pcs
	white	milky	1/1	pcs



Lamp base type: thermoplastic material
 Lampshade: glass

F4.0015 Round light fixtures Riva 100W, lampshade transparent

Color	Box	Unit
white	1/5	pcs

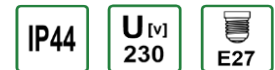
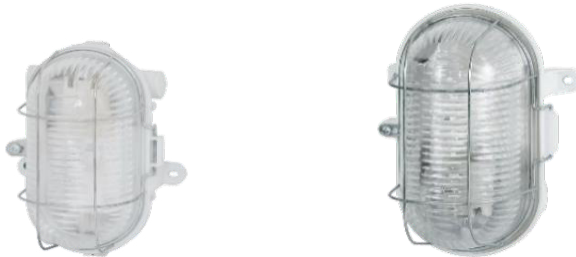

Lamp base type: thermoplastic material
 Lampshade: glass

F4.0003 Oval light fixtures 60W, base thermoplastic metal fence
F4.0205 Oval light fixtures 100W, base thermoplastic metal fence

Color	Box	Unit
grey	1/1	pcs
grey	1/1	pcs

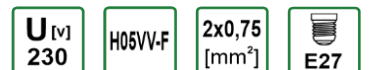

Lamp base type: thermoplastic material

		Protection class	Cable lenght	Cover material	Box	Unit
61050	Metallic cage and reflector Aladin 5	IP20	5m	galvanized steel	1/20	pcs
61060	Metallic cage and reflector Aladin 10	IP20	10m	galvanized steel	1/20	pcs
62531	Aluminium reflector Inter 5	IP40	5m	polycarbonate	1/10	pcs
62541	Aluminium reflector Inter 10	IP40	10m	polycarbonate	1/10	pcs

FLEXIBLE CORRUGATED PIPES GUS

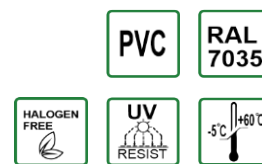

Mechanical strength: 320N

		Diameter outside	Diameter inside	Box	Unit
F6.0013	Flexible corrugated pipes 10	10 mm	14,4 mm	30	lm
F6.0014	Flexible corrugated pipes 12	12 mm	16,4 mm	30	lm
F6.0015	Flexible corrugated pipes 16	16 mm	20,4 mm	30	lm
F6.0016	Flexible corrugated pipes 20	20 mm	24,7 mm	30	lm
F6.0017	Flexible corrugated pipes 25	25 mm	30,6 mm	30	lm
F6.0018	Flexible corrugated pipes 32	32 mm	38 mm	30	lm
F6.0031	Flexible corrugated pipes 40	40 mm	46,4 mm	30	lm
F6.0032	Flexible corrugated pipes 50	50 mm	56,8 mm	30	lm

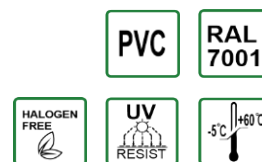

Mechanical strength: 320N

		Diameter outside	Diameter inside	Box	Unit
F6.0068	Flexible corrugated pipes 10	10 mm	14,4 mm	30	lm
F6.0069	Flexible corrugated pipes 12	12 mm	16,4 mm	30	lm
F6.0070	Flexible corrugated pipes 16	16 mm	20,4 mm	30	lm
F6.0071	Flexible corrugated pipes 20	20 mm	24,7 mm	30	lm
F6.0072	Flexible corrugated pipes 25	25 mm	30,6 mm	30	lm
F6.0073	Flexible corrugated pipes 32	32 mm	38 mm	30	lm
F6.0074	Flexible corrugated pipes 40	40 mm	46,4 mm	30	lm
F6.0075	Flexible corrugated pipes 50	50 mm	56,8 mm	30	lm

GLANDS FOR FLEXIBLE CORRUGATED PIPES GUS

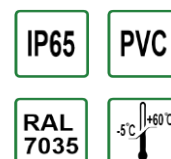

		Thread type	Pipe diameter	Box	Unit
F6.0076	Gland for flexible corrugated pipes GUS Ø 10mm	MG16	16 mm	1/100	pcs
F6.0026	Gland for flexible corrugated pipes GUS Ø 12mm	MG16	16 mm	1/100	pcs
F6.0027	Gland for flexible corrugated pipes GUS Ø 16mm	MG20	20 mm	1/50	pcs
F6.0028	Gland for flexible corrugated pipes GUS Ø 20mm	MG25	25 mm	1/50	pcs
F6.0029	Gland for flexible corrugated pipes GUS Ø 25mm	MG32	32 mm	1/25	pcs
F6.0077	Gland for flexible corrugated pipes GUS Ø 32mm	MG40	40 mm	1/25	pcs
F6.0366	Gland for flexible corrugated pipes GUS Ø 40mm	MG50	50 mm	1/20	pcs
F6.0367	Gland for flexible corrugated pipes GUS Ø 50mm	MG63	63 mm	1/10	pcs

CORRUGATED TUBES - PCV



Mechanical strength: 320N

			Diameter outside	Diameter inside	Box	Unit
F6.0330	Corrugated tubes	PCV 16/11	16 mm	11 mm	25	1m
F6.0332	Corrugated tubes	PCV 20-14	20 mm	14 mm	25	1m
F6.0334	Corrugated tubes	PCV 25/19	25mm	19 mm	25	1m
F6.0335	Corrugated tubes	PCV 32/25	32 mm	25 mm	25	1m
F6.0336	Corrugated tubes	PCV 40/32	40 mm	32 mm	25	1m
F6.0337	Corrugated tubes	PCV 50/42	50 mm	42 mm	25	1m
F6.0329	Corrugated tubes	PCV 16/11	16 mm	11 mm	50	1m
F6.0331	Corrugated tubes	PCV 20-14	20 mm	14 mm	50	1m
F6.0333	Corrugated tubes	PCV 25/19	25 mm	19 mm	50	1m
F6.0339	Corrugated tubes	PCV 16/11 with wire's pilot	16 mm	11 mm	25	1m
F6.0341	Corrugated tubes	PCV 20-14 with wire's pilot	20 mm	14 mm	25	1m
F6.0343	Corrugated tubes	PCV 25/19 with wire's pilot	25mm	19 mm	25	1m
F6.0344	Corrugated tubes	PCV 32/25 with wire's pilot	32 mm	25 mm	25	1m
F6.0345	Corrugated tubes	PCV 40/32 with wire's pilot	40 mm	32 mm	25	1m
F6.0346	Corrugated tubes	PCV 50/42 with wire's pilot	50 mm	42 mm	25	1m
F6.0338	Corrugated tubes	PCV 16/11 with wire's pilot	16 mm	11 mm	50	1m
F6.0340	Corrugated tubes	PCV 20-14 with wire's pilot	20 mm	14 mm	50	1m
F6.0342	Corrugated tubes	PCV 25/19 with wire's pilot	25 mm	19 mm	50	1m

CORRUGATED TUBES - PE



			Diameter outside	Diameter inside	Box	Unit
F6.0313	Corrugated tubes	PE 10/7	10 mm	7 mm	50	1m
F6.0314	Corrugated tubes	PE 12/9	12 mm	9 mm	50	1m
F6.0315	Corrugated tubes	PE 14/11	14 mm	11 mm	50	1m
F6.0316	Corrugated tubes	PE 18/13,5	18 mm	13,5 mm	50	1m
F6.0317	Corrugated tubes	PE 20/15	20 mm	15 mm	50	1m
F6.0318	Corrugated tubes	PE 22/18	22 mm	18 mm	50	1m
F6.0319	Corrugated tubes	PE 28/23	28 mm	23 mm	50	1m
F6.0320	Corrugated tubes	PE 34/29	34 mm	29 mm	50	1m
F6.0321	Corrugated tubes	PE 43/36	43 mm	36 mm	50	1m
F6.0322	Corrugated tubes	PE 10/7 cut open	10 mm	7 mm	50	1m
F6.0323	Corrugated tubes	PE 12/9 cut open	12 mm	9 mm	50	1m
F6.0324	Corrugated tubes	PE 14/11 cut open	14 mm	11 mm	50	1m
F6.0325	Corrugated tubes	PE 18/13,5 cut open	18 mm	13,5 mm	50	1m
F6.0326	Corrugated tubes	PE 20/15 cut open	20 mm	15 mm	50	1m
F6.0327	Corrugated tubes	PE 22/18 cut open	22 mm	18 mm	50	1m
F6.0328	Corrugated tubes	PE 28/23 cut open	28 mm	23 mm	50	1m

WIRE GRIP



PP

		Belt length	Diameter bundles	Box	Unit
F6.0002	Wire grip UP 22 white	60 mm	9 - 22 mm	100 pcs	pkg
F6.0004	Wire grip UP 30 white	80 mm	14 - 30 mm	50 pcs	pkg
F6.0353	Wire grip UP 50 white	130 mm	30 - 50 mm	10 pcs	pkg
F6.0003	Wire grip UP 22 black UV	60 mm	9 - 22 mm	100 pcs	pkg
F6.0122	Wire grip UP 30 black UV	80 mm	14 - 30 mm	50 pcs	pkg
F6.0352	Wire grip UP 50 black UV	130 mm	30 - 50 mm	10 pcs	pkg

CABLE CLAMP WITH NAIL



PE

		Box	Unit
F6.0041	Cable clamp - round - Ø 4mm	100 pcs	pkg
F6.0042	Cable clamp - round - Ø 5mm	100 pcs	pkg
F6.0043	Cable clamp - round - Ø 6mm	100 pcs	pkg
F6.0044	Cable clamp - round - Ø 7mm	100 pcs	pkg
F6.0045	Cable clamp - round - Ø 8mm	100 pcs	pkg
F6.0046	Cable clamp - round - Ø 10mm	100 pcs	pkg
F6.0047	Cable clamp - round - Ø 12mm	100 pcs	pkg
F6.0055	Cable clamp - straight - 10/6mm (3x1,5)	100 pcs	pkg
F6.0056	Cable clamp - straight - 13/7mm (3x2,5)	100 pcs	pkg

ALUMINIUM TAPE

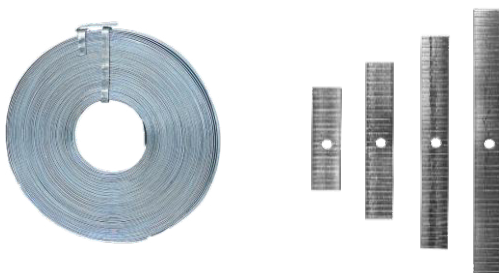

Al

		Ø hole	Length	Width	Thickness	Box	Unit
F6.0008	Aluminum tape - rolled	----	~ 33 m	10 mm	1 mm	1/1	kg
F6.0117	Aluminum tape with hole - 60x10	2,9 mm	60 mm	10 mm	1 mm	1/1	kg
F6.0118	Aluminum tape with hole - 80x10	2,9 mm	80 mm	10 mm	1 mm	1/1	kg
F6.0119	Aluminum tape with hole - 100x10	2,9 mm	100 mm	10 mm	1 mm	1/1	kg

CABLE TIES

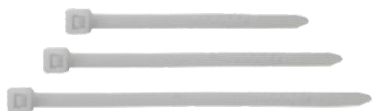

		Diameter	Breaking	Box	Unit
		bundles	force		
F6.0123	Cable ties 100/2,5 white	2 - 22 mm	8 kg	100 pcs	pkg
F6.0124	Cable ties 150/2,5 white	2 - 35 mm	8 kg	100 pcs	pkg
F6.0125	Cable ties 200/2,5 white	3 - 53 mm	8 kg	100 pcs	pkg
F6.0126	Cable ties 150/3,6 white	3 - 35 mm	18 kg	100 pcs	pkg
F6.0127	Cable ties 200/3,6 white	3 - 53 mm	18 kg	100 pcs	pkg
F6.0128	Cable ties 250/3,6 white	3 - 65 mm	18 kg	100 pcs	pkg
F6.0129	Cable ties 300/3,6 white	3 - 80 mm	18 kg	100 pcs	pkg
F6.0130	Cable ties 350/3,6 white	3 - 95 mm	18 kg	100 pcs	pkg
F6.0131	Cable ties 200/4,8 white	3 - 53 mm	22 kg	100 pcs	pkg
F6.0132	Cable ties 250/4,8 white	3 - 65 mm	22 kg	100 pcs	pkg
F6.0133	Cable ties 300/4,8 white	3 - 80 mm	22 kg	100 pcs	pkg
F6.0134	Cable ties 360/4,8 white	3 - 95 mm	22 kg	100 pcs	pkg
F6.0135	Cable ties 450/4,8 white	3 - 130 mm	22 kg	100 pcs	pkg
F6.0136	Cable ties 200/7,6 white	4 - 50 mm	55 kg	100 pcs	pkg
F6.0137	Cable ties 300/7,6 white	4 - 80 mm	55 kg	100 pcs	pkg
F6.0138	Cable ties 365/7,6 white	4 - 98 mm	55 kg	100 pcs	pkg
F6.0139	Cable ties 430/7,6 white	4 - 125 mm	55 kg	100 pcs	pkg
F6.0140	Cable ties 530/7,6 white	4 - 160 mm	55 kg	100 pcs	pkg
F6.0141	Cable ties 750/7,6 white	4 - 220 mm	55 kg	100 pcs	pkg
F6.0142	Cable ties 100/2,5 black UV	2 - 22 mm	8 kg	100 pcs	pkg
F6.0143	Cable ties 150/2,5 black UV	2 - 35 mm	8 kg	100 pcs	pkg
F6.0144	Cable ties 200/2,5 black UV	3 - 53 mm	8 kg	100 pcs	pkg
F6.0145	Cable ties 150/3,6 black UV	3 - 35 mm	18 kg	100 pcs	pkg
F6.0146	Cable ties 200/3,6 black UV	3 - 53 mm	18 kg	100 pcs	pkg
F6.0147	Cable ties 250/3,6 black UV	3 - 65 mm	18 kg	100 pcs	pkg
F6.0148	Cable ties 300/3,6 black UV	3 - 80 mm	18 kg	100 pcs	pkg
F6.0149	Cable ties 350/3,6 black UV	3 - 95 mm	18 kg	100 pcs	pkg
F6.0150	Cable ties 200/4,8 black UV	3 - 53 mm	22 kg	100 pcs	pkg
F6.0151	Cable ties 250/4,8 black UV	3 - 65 mm	22 kg	100 pcs	pkg
F6.0152	Cable ties 300/4,8 black UV	3 - 80 mm	22 kg	100 pcs	pkg
F6.0153	Cable ties 360/4,8 black UV	3 - 95 mm	22 kg	100 pcs	pkg
F6.0154	Cable ties 450/4,8 black UV	3 - 130 mm	22 kg	100 pcs	pkg
F6.0155	Cable ties 200/7,6 black UV	4 - 50 mm	55 kg	100 pcs	pkg
F6.0156	Cable ties 300/7,6 black UV	4 - 80 mm	55 kg	100 pcs	pkg
F6.0157	Cable ties 365/7,6 black UV	4 - 98 mm	55 kg	100 pcs	pkg
F6.0158	Cable ties 430/7,6 black UV	4 - 125 mm	55 kg	100 pcs	pkg
F6.0159	Cable ties 530/7,6 black UV	4 - 160 mm	55 kg	100 pcs	pkg
F6.0160	Cable ties 750/7,6 black UV	4 - 220 mm	55 kg	100 pcs	pkg

SELF-STRICK ELEMENTS



		Box	Unit
F6.0164	Self-strick elements 19x19 mm white	100 pcs	pkg
F6.0166	Self-strick elements 25x25 mm white	50 pcs	pkg
F6.0165	Self-strick elements 19x19 mm black	100 pcs	pkg
F6.0167	Self-strick elements 25x25 mm black	50 pcs	pkg

CABLE FOIL



Package: 100m

	Type	Width	Thickness	Box	Unit
F6.0005	Warning cable foil - 200x0,09 blue	>1kV	200 mm	0,09 mm	1/1 pcs
F6.0006	Warning cable foil - 200x0,09 red	<1kV	200 mm	0,09 mm	1/1 pcs

WARNING FOIL



	Width	Thickness	Box	Unit
F6.0019	Warning foil white-red	75 mm	0,05 mm	1/1 pcs

EARTHING ROD

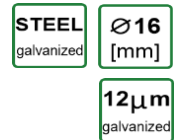
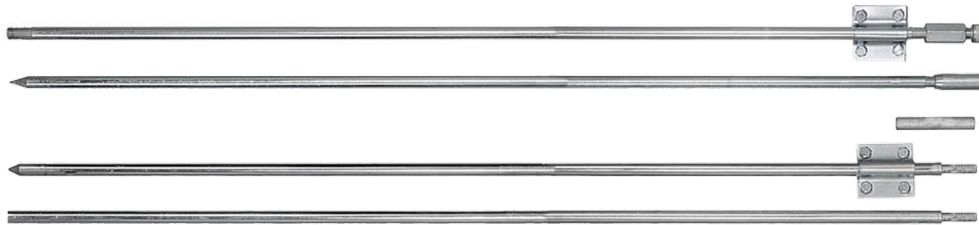

	Length [m]	Type of connection	Box	Unit
F8.0001	Thread earthing rod set - base + extender + cross connector	3 threaded	1/5	pcs
F8.0002	Thread earthing rod - base + cross connector	1,5 threaded	1/10	pcs
F8.0003	Thread earthing rod - extender	1,5 threaded	1/12	pcs
F8.0004	Threadless earthing rod set - base + extender + cross connector	3 folding	1/5	pcs
F8.0005	Threadless earthing rod - extender	1,5 folding	1/12	pcs
F8.0006	Threadless earthing rod - base	1,5 folding	1/12	pcs
F8.0007	Cross connector	connecting - wire, stave	1/1	pcs

MANHOLE BOXES



	Protection class	Box	Unit
F8.0008	Manhole box 200mm x 200mm x 200mm	IP40	1/1 pcs
F8.0013	Manhole box 200mm x 200mm x 200mm with gasket	IP44	1/1 pcs
F8.0011	Manhole box 300mm x 300mm x 300mm	IP40	1/1 pcs
F8.0012	Manhole box 400mm x 400mm x 400mm	IP40	1/1 pcs

JUNCTION BOXES



Mounting hole: 185x135x50 mm
Dimensions: 230x180 mm

	Cover material	Box	Unit
F8.0009	Junction box with metal door - WHITE	powder coated steel	1/1 pcs
F8.0010	Junction box with metal door - INOX	galvanized steel	1/1 pcs

PICTOGRAM MARKING

	Voltage rating		Working range (temperature)		Housing material: ABS
	Rated current		Possibility of connecting wires : Al/Cu		Housing material: LDPE polyethylene
	Power		Housing dimensions		Housing material: Polyamide
	Frequency		Coating: electro-galvanized 12µM.		Housing material: Polyamide 66
	IP protection class		Cover fixing: metal screw		Housing material: Polycarbonate
	The degree of mechanical strength		Cover fixing: stainless screw		Housing material: Polyethylene
	Glow wire test		Cover fixing: plastic screw		Housing material: PE-HD
	Material type: halogen-free		Cover fixing: click		Housing material: Polypropylene
	Resistant to UV radiation		Cable fixing: screw		Housing material: PP-C
	Sockets type: French standard		Product mounting: TH35 rail		Housing material: Polystyrene
	Diameter		Installation of the product: to the ground		Housing material: PVC
	Air flow direction: from outside to inside		Product connection: modular		Housing material: PC UL94, V-2
	Product color		Type of wire		Housing material: PVC - UL 94 V0
	Cable stripping length		Type of wire		Housing material: ABS / PC
	Protection class: II		Type of wire		Housing material: ABS / STEEL
	Drum diameter		Type of wire		Housing material: Polyamide / Polycarbonate
	Equipment: N + PE terminals		Type of wire		Housing material: Polyamide / Polystyrene
	The product includes a gland		Clamp material: aluminum		Body material: Polyethylene Cover material: Polypropylene
	Material thickness		Clamp material: tinned copper		Housing material: PP/PCW
	Type thread of lamp holder: E27		Clamp material: brass		Housing material: Polypropylene / PVC
	Fixture of the holder		Contact material: brass		Housing material: PVC / Cu



F-ELEKTRO Sp. z o.o. Sp. kom.
Wałowa 30 St. 34-100 Wadowice
tel. +48 33 873 31 73
info@f-elektro.com
www.f-elektro.com